



Beschreibung

IP66, SKI. SKII auf Anfrage. IK07. Korrosionsbeständiger Aluminiumguss. PCS beschichtete Edelstahlschrauben. 5CE Korrosionsschutz. CCG® Controlled Compression Gasket Silikondichtung. Sicherheitsglas. Eine Kabelverschraubung, eine zweite Kabelverschraubung zur Durchverdrahtung auf Anfrage. Eingebaute elektronische Betriebsgeräte, thermisch getrennt. CAD-optimierte OLC® One LED Concept Technik zur Lichtlenkung und Entblendung. Eingebaute LED Platine. 1-10V, DALI Schnittstelle oder Eco Step Dim® auf Anfrage. Maximal ein internes Zubehörteil möglich. Variante mit 2200 K bis max. 1050 mA erhältlich, nicht für [EES] Version. Bei Bestellung bitte angeben.

Gewicht	17.50 kg
Lichtverteilung	symmetrisch mediumstrahlend [M]
Lichtquelle	LED-36/72W / 700 mA - 3000 K
CRI	80
Netz	EVG
LEDs	36
Bemessungsleistung	79 W

Nominal Lichtstrom (lm)

LED Lumen	290
Total Lumen	10440
Tj	85

Bemessungslichtstrom (lm)

LED Lumen	262.7
Total Lumen	9457
Ta	25

WE-EF Switzerland AG

Himmelrichstrasse 6, 6003 Luzern - Tel: +41 41 210 49 95

info.switzerland@we-ef.com - https://we-ef.com/ch_de

Technische Änderungen und Irrtümer vorbehalten. - Erstellt am 23.11.2024

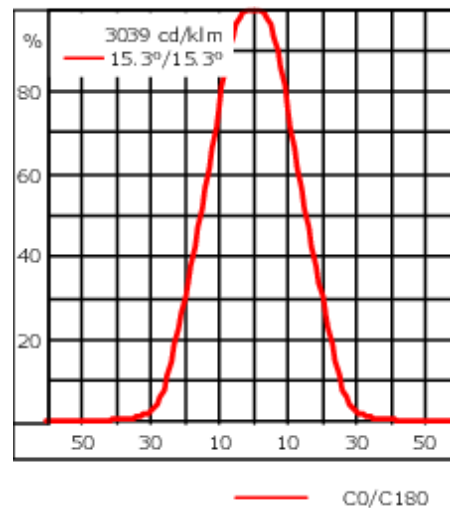
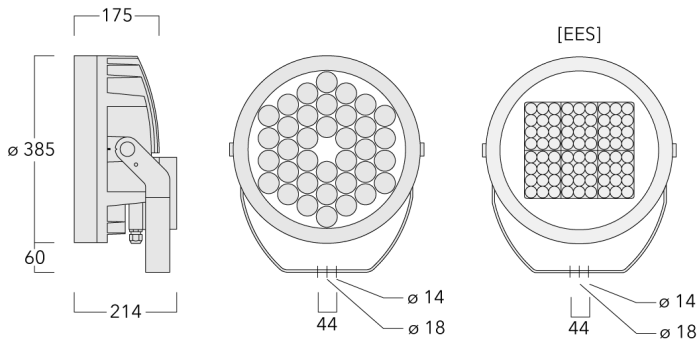

Spezifikationen

Materialbeschreibung

Gehäuse	Korrosionsbeständiger Aluminiumguss
Farben	<div style="display: flex; flex-direction: column; gap: 5px;"> <div> RAL9004 Signalschwarz</div> <div> RAL9007 Graualuminium</div> <div> RAL7016 Anthrazitgrau</div> <div> RAL9016 Verkehrsweiß</div> </div>
Dichtung	CCG® Silikondichtung
Schrauben	PCS beschichtete Edelstahlschrauben
Schutzart	IP66
Schlagfestigkeit	IK07
Korrosionsbeständigkeit	5CE
Windangriffsfläche	0.116 m ²

Elektrische Beschreibung

Netz	220-240V / 50-60 Hz
Netzgerät / Vorschaltgerät	Standard. Variante mit DALI erhältlich, bei Bestellung bitte angeben.

Weitere Informationen

Lebensdauer	Ta=25° L90B10 > 90000h
Energieeffizienzklasse	C-D (Lichtquelle)

WE-EF Switzerland AG

Himmelrichstrasse 6, 6003 Luzern - Tel: +41 41 210 49 95
 info.switzerland@we-ef.com - https://we-ef.com/ch_de
 Technische Änderungen und Irrtümer vorbehalten. - Erstellt am 23.11.2024

Montagezubehör

Montagesockel EM

Beschreibung	Artikelnummer	D1	D2	H1	M1	Gewicht (kg)
EM1-M16 AL	270-9038	160	130	203	9	2

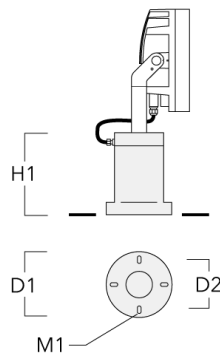

Erdstück

Beschreibung	Artikelnummer	D1	D2	D3	D4	H1	H2	M1	Gewicht (kg)
Erdstück ESV4	300-0461	145	130	102	108	400	350	8	7.05

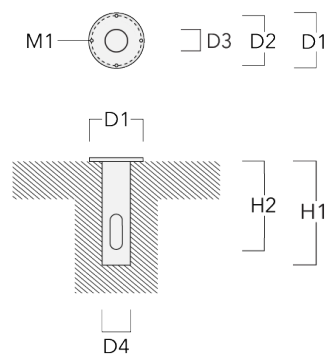

Mastaufsatztraverse TA

Beschreibung	Artikelnummer	A	C1	D x L1	Gewicht (kg)	D x S
TA2 Mastaufsatztraverse, zweifach (Ø 76 x 200)	147-0024		130	76 x 200	1.90	76 x 200

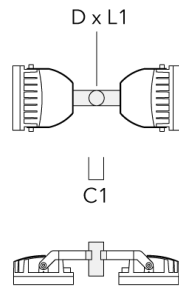

TA1 Mastaufsatztraverse, einfach* (Ø 76 x 200)	147-0023		130	76 x 200	1.90	76 x 200
--	----------	--	-----	----------	------	----------

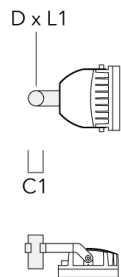

Beschreibung	Artikelnummer	A	C1	D x L1	Gewicht (kg)	D x S
TA2-L Mastaufsatztraverse, zweifach (Ø 76 x 200)	147-0105	±90°	420	76 x 200	16.10	76 x 200

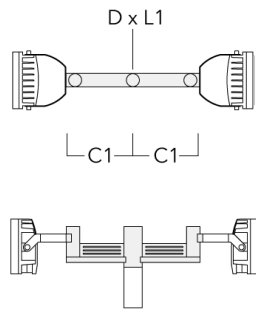

TA3 Mastaufsatztraverse, dreifach (Ø 89 x 200)	147-0025	±90°	650	89 x 200	17.90	89 x 200
--	----------	------	-----	----------	-------	----------



Beschreibung	Artikelnummer	A	C1	D x L1	Gewicht (kg)	D x S
TA4 Mastaufsatztraverse, vierfach (Ø 89 x 200)	147-0099	±90°	650	89 x 200	20.80	89 x 200

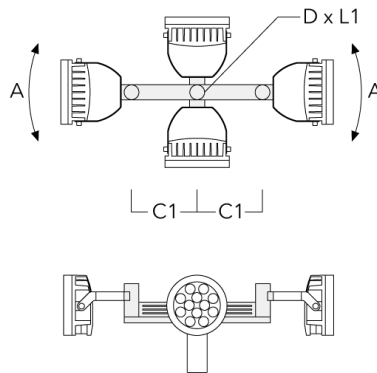

TA1 Mastaufsatztraverse, einfach (Ø 108 x 200)	147-0096		130	108 x 200	7.50	108 x 200
--	----------	--	-----	-----------	------	-----------

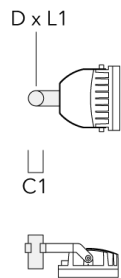

Beschreibung	Artikelnummer	A	C1	D x L1	Gewicht (kg)	D x S
TA2 Mastaufsatztraverse, zweifach (Ø 108 x 200)	147-0097		130	108 x 200	7.50	108 x 200

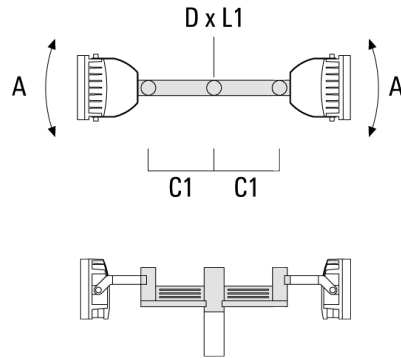

TA3 Mastaufsatztraverse, dreifach (Ø 108 x 200)	147-0098	$\pm 90^\circ$	650	108 x 200	24.20	108 x 200
---	----------	----------------	-----	-----------	-------	-----------

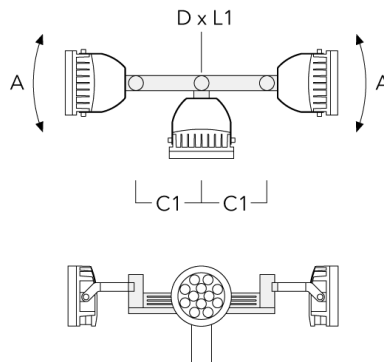

Mastschelle TS

Beschreibung	Artikelnummer	D1	Gewicht (kg)	D
TS1-2/M12 Mastschelle, einfach (Ø 102-114)	147-0526	102-114	1.50	102-114

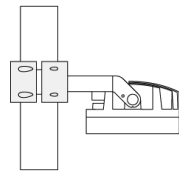
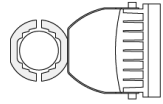

D1

TS1-2/M12 Mastschelle, einfach (Ø 76-89)	147-0543	76-89	1.40	76-89
--	----------	-------	------	-------

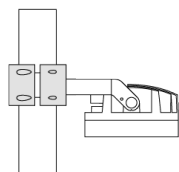
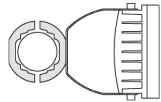

D1

Beschreibung	Artikelnummer	D1	Gewicht (kg)	D
TS1-2/M12 Mastschelle, einfach (Ø 114-133)	147-0544	114-133	1.70	114-133

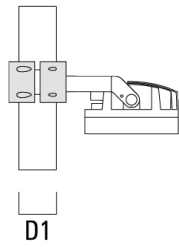
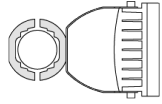

TS2-2/M12 Mastschelle, zweifach (Ø 76-89)	147-0545	76-89	1.40	76-89
---	----------	-------	------	-------

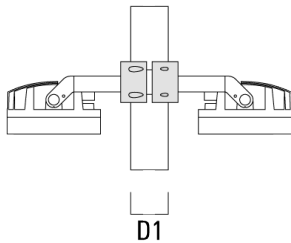
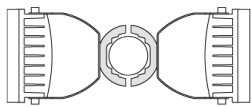

Beschreibung	Artikelnummer	D1	Gewicht (kg)	D
TS2-2/M12 Mastschelle, zweifach (Ø 102-114)	147-0527	102-114	1.50	102-114



TS2-2/M12 Mastschelle, zweifach (Ø 114-133)	147-0546	114-133	1.60	114-133
---	----------	---------	------	---------

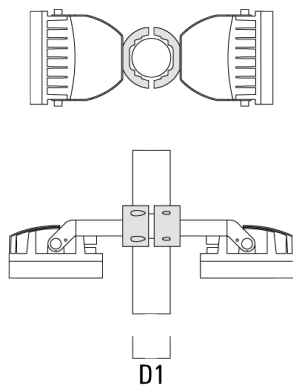

Mastschelle PC

Beschreibung	Artikelnummer	D1	Gewicht (kg)
PC2 76-89/60 Mastschelle, zweifach (Ø 76-89)	139-2703	76-89	1.00

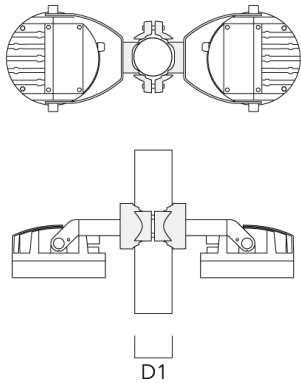

PC1 76-89/60 Mastschelle, einfach (Ø 76-89)	139-2702	76-89	1.00
---	----------	-------	------

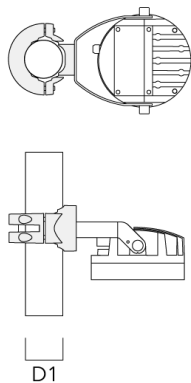

Beschreibung	Artikelnummer	D1	Gewicht (kg)
PC2 102-114/60 Mastschelle, zweifach (Ø 102-114)	139-2707	102-114	1.20



PC1 102-114/60 Mastschelle, einfach (Ø 102-114)	139-2706	102-114	1.20
--	----------	---------	------

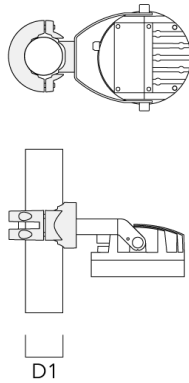

Beschreibung	Artikelnummer	D1	Gewicht (kg)
PC2 114-133/60 Mastschelle, zweifach (Ø 114-133)	139-2709	114-133	1.40



PC1 114-133/60 Mastschelle, einfach (Ø 114-133)	139-2708	114-133	1.40
--	----------	---------	------



139-1806

FLC260 LED

we-ef

Beschreibung	Artikelnummer	D1	Gewicht (kg)
PC2 82-109/60 Mastschelle, zweifach (Ø 82-109)	139-2705	82-109	1.10



WE-EF Switzerland AG

Himmelrichstrasse 6, 6003 Luzern - Tel: +41 41 210 49 95

info.switzerland@we-ef.com - https://we-ef.com/ch_de

Technische Änderungen und Irrtümer vorbehalten. - Erstellt am 23.11.2024

139-1806

FLC260 LED

we-ef

Steuerung

Eco Step Dim® Basic

Beschreibung	Artikelnummer
Eco Step Dim® Basic LED	430-0001

Eco Step Dim® Advanced

Beschreibung	Artikelnummer
Eco Step Dim® Advanced LED	430-0002

R2C Ready to Connect

Beschreibung	Artikelnummer
R2C Ready to Connect (oben)	430-0019

WE-EF Switzerland AG

Himmelrichstrasse 6, 6003 Luzern - Tel: +41 41 210 49 95

info.switzerland@we-ef.com - https://we-ef.com/ch_de

Technische Änderungen und Irrtümer vorbehalten. - Erstellt am 23.11.2024

139-1806

FLC260 LED

we-ef

Optisches Zubehör

Streulinse bandförmig

Beschreibung	Artikelnummer	C1
IO-180-FLC260-LED	139-1861	332

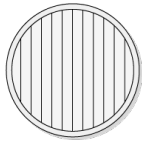

C1

Streulinse allseitig

Beschreibung	Artikelnummer	C1
IO-360-FLC260-LED	139-1862	332

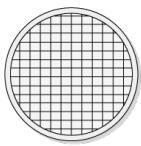

C1

WE-EF Switzerland AG

Himmelrichstrasse 6, 6003 Luzern - Tel: +41 41 210 49 95

info.switzerland@we-ef.com - https://we-ef.com/ch_de

Technische Änderungen und Irrtümer vorbehalten. - Erstellt am 23.11.2024

139-1806

FLC260 LED

we-ef

Wabenblende

Beschreibung	Artikelnummer	C1
IW-03-FLC260-LED - [E][EE][EES]	139-1863	324

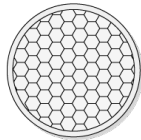

C1

Abblendtubus

Beschreibung	Artikelnummer	A	C1
ET-FLC260-LED	139-1865	222	393

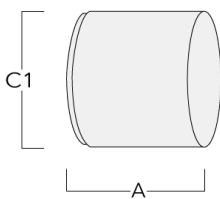

WE-EF Switzerland AG

Himmelrichstrasse 6, 6003 Luzern - Tel: +41 41 210 49 95

info.switzerland@we-ef.com - https://we-ef.com/ch_de

Technische Änderungen und Irrtümer vorbehalten. - Erstellt am 23.11.2024

139-1806

FLC260 LED

we-ef

Seitenblende

Beschreibung	Artikelnummer	A	C1
ES-FLC260-LED	139-1864	222	393

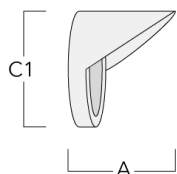

WE-EF Switzerland AG

Himmelrichstrasse 6, 6003 Luzern - Tel: +41 41 210 49 95

info.switzerland@we-ef.com - https://we-ef.com/ch_de

Technische Änderungen und Irrtümer vorbehalten. - Erstellt am 23.11.2024