

139-1793

FLC260 LED

we-ef



Description

IP66. Class I. IK07. Marine-grade, die-cast aluminum alloy. 5CE superior corrosion protection including PCS hardware. Silicone CCG® Controlled Compression Gasket. Safety glass lens. One cable gland, second gland for through wiring on request. CAD-optimized optics for superior illumination and glare control. Integral driver, thermally separated. OLC® One LED Concept. Factory-installed LED circuit board. 0-10V Dimming on request.

A maximum of one internal optical accessory.

Specify product with 7 Digit product code - Finish Color. Accessories, such as mounting, optical, and electrical, must be specified separately.

Example: XXX-XXXX-9004 (Black)
+ XXX-XXXX (Accessory 1)

Weight	38.58 lb
Light distribution	symmetric, narrow beam [N]
Light source	LED-36/108W / 1050 mA - 3000 K
CRI	80
Power supply	electronic gear
LEDs	36
Rated input power	119 W

Nominal Lumen (lm)

LED Lumen	430
Total Lumen	15480
Tj	85

Rated lumens (lm)

LED Lumen	366.4
Total Lumen	13191.4
Ta	25

WE-EF LIGHTING USA, LLC

410-D Keystone Drive, 15086 Warrendale, PA 15086 - Phone: +1 724 742 0030
customersupport.usa@we-ef.com - <https://we-ef.com/us>
Subject to technical changes and errors. - Generated on 11/23/2024

139-1793

FLC260 LED

we-ef

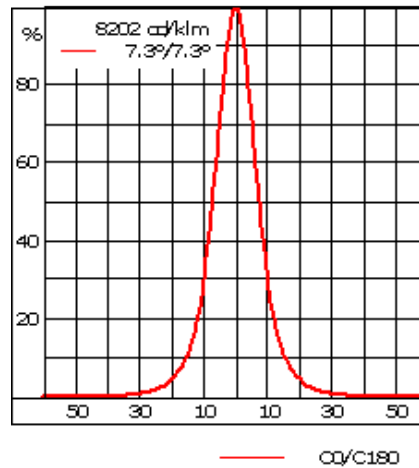
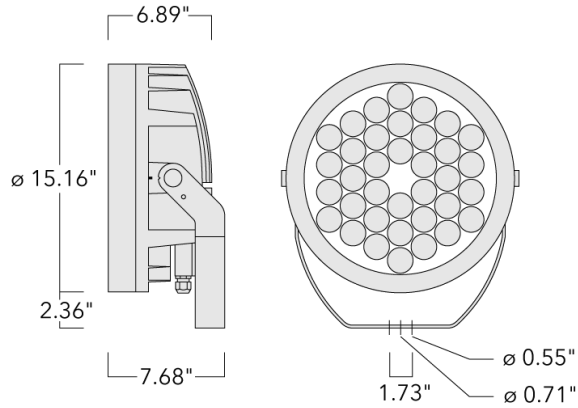

Specifications

Material description

Body	Marine-grade, die-cast aluminium alloy
Lens	Safety glass lens
Colors	<div style="display: flex; flex-direction: column; gap: 5px;"> <div> RAL9004 Black</div> <div> RAL9007 Grey Metallic</div> <div> RAL9016 White</div> <div> RAL8019 Dark Bronze</div> </div>
Gasket	Silicone CCG® Controlled Compression Gasket
Fasteners	PCS Polymer Coated Stainless Steel Hardware
Ingress protection	IP66
Impact resistance	IK07
Corrosion resistance	5CE
Windage	1.5

WE-EF LIGHTING USA, LLC

410-D Keystone Drive, 15086 Warrendale, PA 15086 - Phone: +1 724 742 0030

customersupport.usa@we-ef.com - <https://we-ef.com/us>

Subject to technical changes and errors. - Generated on 11/23/2024

139-1793

FLC260 LED

we-ef

Electrical description

Power supply	Integral [ECG] electronic driver 120V-277V. 0-10V dimmable, to be specified with order.
Driver / Ballast	Integral EC electronic converter in thermally-separated compartment
Power factor	> 0.9
Surge protection	Integral 10kV Surge Protector

Additional information

Lifetime	Ta=25°/40° L90B10 > 90000h
Listings	ETL, UL-1598, CSA-C22.2#250.0. Suitable for Wet Locations.

WE-EF LIGHTING USA, LLC

410-D Keystone Drive, 15086 Warrendale, PA 15086 - Phone: +1 724 742 0030
customersupport.usa@we-ef.com - <https://we-ef.com/us>
Subject to technical changes and errors. - Generated on 11/23/2024

139-1793

FLC260 LED

we-ef

Mounting Accessories

Short post EM

Description	Part ID	D1	D2	H1	M1	Weight (lb)
EM1-M16 AL - Single Cable Entry	270-9038	6.3	5.12	7.87"	0.35"	4.85 lbs

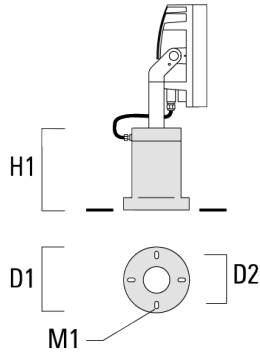

WE-EF LIGHTING USA, LLC

410-D Keystone Drive, 15086 Warrendale, PA 15086 - Phone: +1 724 742 0030
customersupport.usa@we-ef.com - <https://we-ef.com/us>

Subject to technical changes and errors. - Generated on 11/23/2024

FLC260 LED

Planted root

Description	Part ID	D1	D2	D3	D4	H1	H2	M1	Weight (lb)
Planted root ESV4	300-0461	5.71	5.12	4.01	4.25	15.75	13.78	.31	15.54

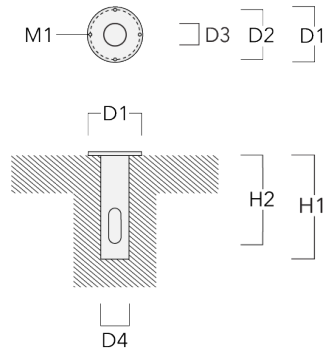

Floodlight mounting bracket TA

Description	Part ID	A	C1	D x L1	L	Weight (lb)	D x S
TA2 Mounting bracket, double (Ø 3 x 8)	147-0024		5.12	3 x 8	2.99	4.2 lbs	76 x 200

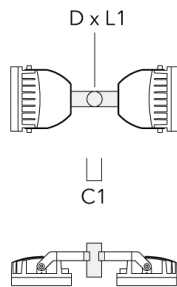

WE-EF LIGHTING USA, LLC

410-D Keystone Drive, 15086 Warrendale, PA 15086 - Phone: +1 724 742 0030
 customersupport.usa@we-ef.com - <https://we-ef.com/us>
 Subject to technical changes and errors. - Generated on 11/23/2024

FLC260 LED

Description	Part ID	A	C1	D x L1	L	Weight (lb)	D x S
TA2-L Mounting bracket, double (Ø 3 x 8)	147-0105	±90°	16.54	3 x 8	2.99	35.49	76 x 200

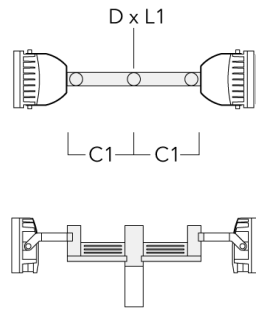

TA3 Mounting bracket, triple (Ø 3.50 x 8)	147-0025	±90°	25.59	3.50 x 8	3.5	39.46	89 x 200
---	----------	------	-------	----------	-----	-------	----------

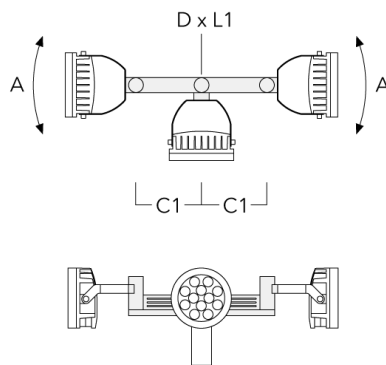

WE-EF LIGHTING USA, LLC

410-D Keystone Drive, 15086 Warrendale, PA 15086 - Phone: +1 724 742 0030
 customersupport.usa@we-ef.com - <https://we-ef.com/us>

Subject to technical changes and errors. - Generated on 11/23/2024

FLC260 LED

Description	Part ID	A	C1	D x L1	L	Weight (lb)	D x S
TA4 Mounting bracket, quad (Ø 3.50 x 8)	147-0099	±90°	25.59	3.50 x 8		45.86 lbs	89 x 200

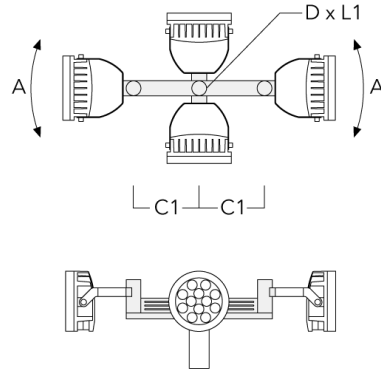

TA1 Mounting bracket, single (Ø 4.25 x 8)	147-0096		5.12	4.25 x 8	4.25	16.53	108 x 200
---	----------	--	------	----------	------	-------	-----------

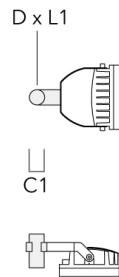

WE-EF LIGHTING USA, LLC

410-D Keystone Drive, 15086 Warrendale, PA 15086 - Phone: +1 724 742 0030
 customersupport.usa@we-ef.com - <https://we-ef.com/us>
 Subject to technical changes and errors. - Generated on 11/23/2024

139-1793

we-ef

FLC260 LED

Description	Part ID	A	C1	D x L1	L	Weight (lb)	D x S
TA3 Mounting bracket, triple (Ø 4.25 x 8)	147-0098	±90°	25.59"	4.25 x 8		53.35 lbs	108 x 200

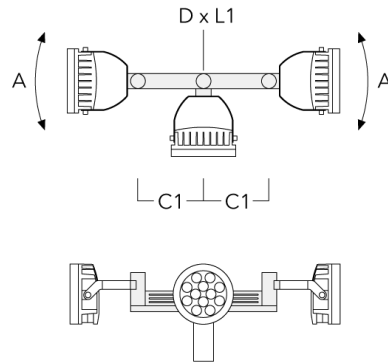

Pole clamp TS

Description	Part ID	D1	Weight (lb)	D
TS1-2/M12 Pole clamp, single (Ø 4.0"-4.5")	147-0526	4.0-4.50	3.53	102-114

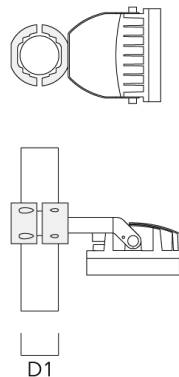

WE-EF LIGHTING USA, LLC

410-D Keystone Drive, 15086 Warrendale, PA 15086 - Phone: +1 724 742 0030
customersupport.usa@we-ef.com - <https://we-ef.com/us>

Subject to technical changes and errors. - Generated on 11/23/2024

139-1793

we-ef

FLC260 LED

Description	Part ID	D1	Weight (lb)	D
TS1-2/M12 Pole clamp, single (Ø 3"-3.5")	147-0543	3.0-3.50	3.31	76-89

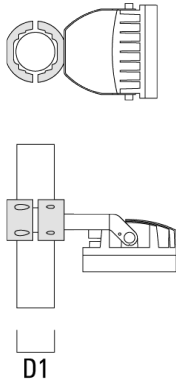

TS1-2/M16 Pole clamp, single (Ø 4.5"-5.25")	147-0544	4.5-5.25	1.70	114-133
---	----------	----------	------	---------

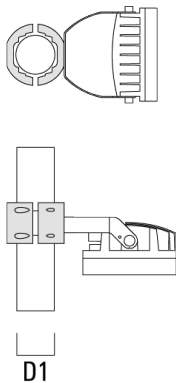

WE-EF LIGHTING USA, LLC

410-D Keystone Drive, 15086 Warrendale, PA 15086 - Phone: +1 724 742 0030

customersupport.usa@we-ef.com - <https://we-ef.com/us>

Subject to technical changes and errors. - Generated on 11/23/2024

139-1793

we-ef

FLC260 LED

Description	Part ID	D1	Weight (lb)	D
TS2-2/M16 Pole clamp, double (Ø 3"-3.5")	147-0545	3.0"-3.5"	3.09 lbs	76-89

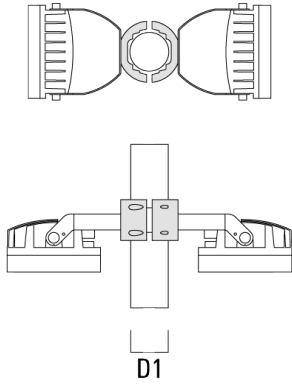

TS2-2/M16 Pole clamp, double (Ø 4.0"-4.5")	147-0527	4.0-4.50	3.31	102-114
--	----------	----------	------	---------

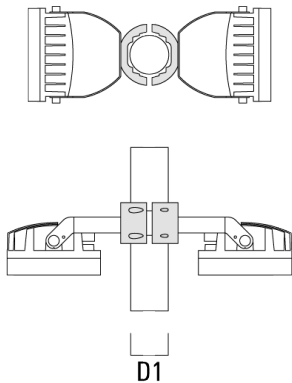

WE-EF LIGHTING USA, LLC

410-D Keystone Drive, 15086 Warrendale, PA 15086 - Phone: +1 724 742 0030
customersupport.usa@we-ef.com - <https://we-ef.com/us>

Subject to technical changes and errors. - Generated on 11/23/2024

139-1793

we-ef

FLC260 LED

Description	Part ID	D1	Weight (lb)	D
TS2-2/M12 Pole clamp, double (Ø 4.5"-5.25")	147-0546	4.50-5.25	3.53	114-133

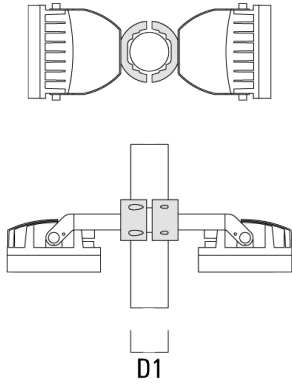

Pole top caps KF

Description	Part ID	D1	D × L1	Weight (lb)	D
KF16-60/M16 Spigot Cap (Ø 2.36")	310-9120	2.36	2.36 x 4	4.4 lbs	60 x 100

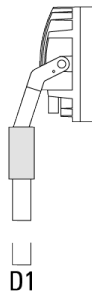

WE-EF LIGHTING USA, LLC

410-D Keystone Drive, 15086 Warrendale, PA 15086 - Phone: +1 724 742 0030

customersupport.usa@we-ef.com - <https://we-ef.com/us>

Subject to technical changes and errors. - Generated on 11/23/2024

139-1793

we-ef

FLC260 LED

Description	Part ID	D1	D × L1	Weight (lb)	D
KF1-76/M16 Spigot Cap (Ø 3.0")	310-9121	3	3 x 4	1.10 lbs	76 x 100

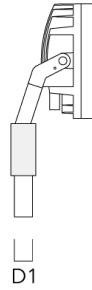

KF16-89/M16 Spigot Cap (Ø 3.5")	300-0734	3.50	3.5 x 3	1.10 lbs	89
---------------------------------	----------	------	---------	----------	----

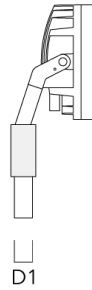

WE-EF LIGHTING USA, LLC

410-D Keystone Drive, 15086 Warrendale, PA 15086 - Phone: +1 724 742 0030
customersupport.usa@we-ef.com - <https://we-ef.com/us>

Subject to technical changes and errors. - Generated on 11/23/2024

FLC260 LED

Description	Part ID	D1	D × L1	Weight (lb)	D
KF16-108/M16 Spigot Cap (Ø 4.25")	300-0735	4.25	4.25 x 3	4.4 lbs	108

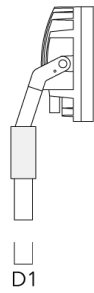

Wall Mount Bracket WMB

Description	Part ID	C1	C2	D1	D2	H1	M1	M2	Weight (lb)
WMB200 Wall mount bracket	147-6015	20.28	4.72	9.25	7.88	11.34	1.05	0.47	20.0 lbs

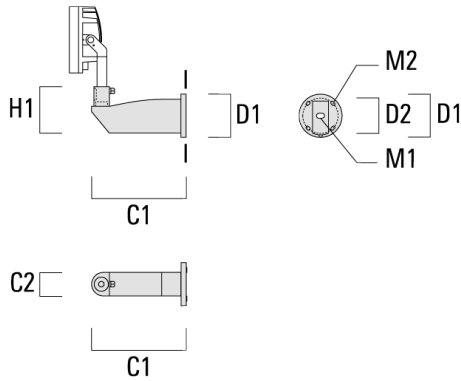

WE-EF LIGHTING USA, LLC

410-D Keystone Drive, 15086 Warrendale, PA 15086 - Phone: +1 724 742 0030

customersupport.usa@we-ef.com - <https://we-ef.com/us>

Subject to technical changes and errors. - Generated on 11/23/2024

139-1793

FLC260 LED

we-ef

Surface Mount Canopy SMC

Description	Part ID	D1	D2	Weight (lb)
SMC-200	147-6915	10.83	9.25	15.4 lbs

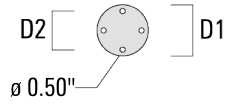

WE-EF LIGHTING USA, LLC

410-D Keystone Drive, 15086 Warrendale, PA 15086 - Phone: +1 724 742 0030
customersupport.usa@we-ef.com - <https://we-ef.com/us>

Subject to technical changes and errors. - Generated on 11/23/2024

Junction box

Description	Part ID	Additional information	A	B	C1	Weight (lb)
Junction box JB20 - Cable side entries	310-9013	Junction boxes are made from marine-grade, die-cast aluminium alloy. IK10. IP66. For side entries and suitable to be used with cable glands.	7.09	5.63	2.01	2.25

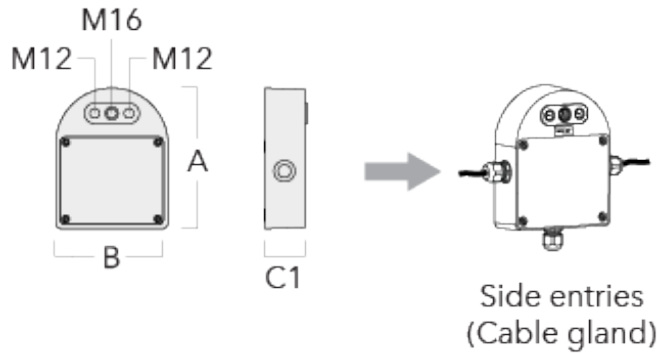

Junction box JB20 - Conduit side entries	310-9014	Junction boxes are made from marine-grade, die-cast aluminium alloy. IK10. IP66. For side entries and suitable to be used with conduits.	7.09	5.63	2.01	2.25
--	----------	--	------	------	------	------

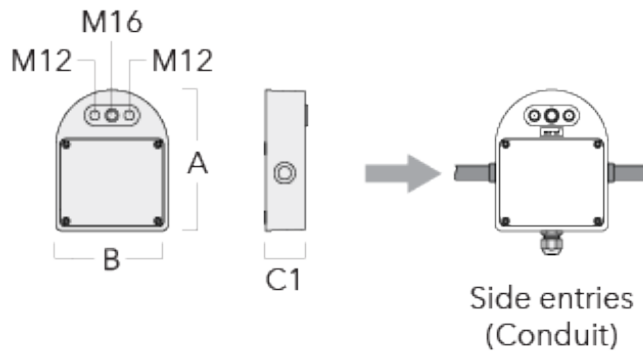

Pole clamp PC

Description	Part ID	D1	Weight (lb)
PC2 76-89/60 Pole clamp, double (Ø 3"-3.5")	139-2703	3.0-3.50	2.20

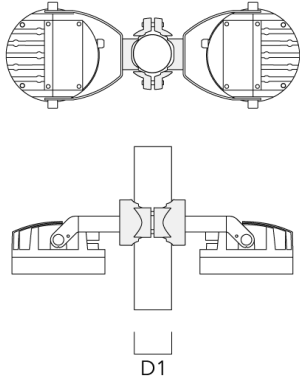

PC1 76-89/60 Pole clamp, single (Ø 3"-3.5")	139-2702	3.0-3.50	2.20
---	----------	----------	------

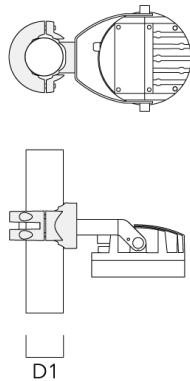

139-1793

we-ef

FLC260 LED

Description	Part ID	D1	Weight (lb)
PC2 102-114/60 Pole clamp, double (Ø 4"-4.5")	139-2707	4.0-4.50	2.65

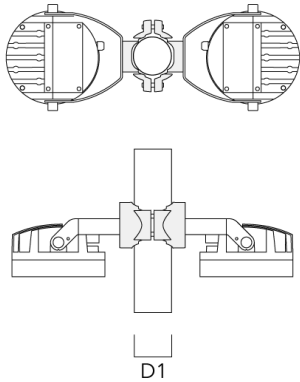

PC1 102-114/60 Pole clamp, single (Ø 4"-4,5")	139-2706	4.0-4.50	2.65
--	----------	----------	------

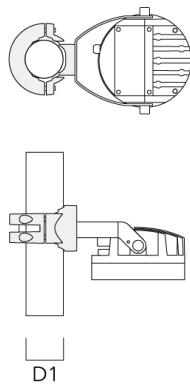

WE-EF LIGHTING USA, LLC

410-D Keystone Drive, 15086 Warrendale, PA 15086 - Phone: +1 724 742 0030
customersupport.usa@we-ef.com - <https://we-ef.com/us>

Subject to technical changes and errors. - Generated on 11/23/2024

139-1793

we-ef

FLC260 LED

Description	Part ID	D1	Weight (lb)
PC2 114-133/60 Pole clamp, double (Ø 4.5"-5.25")	139-2709	4.5-5.25	3.10

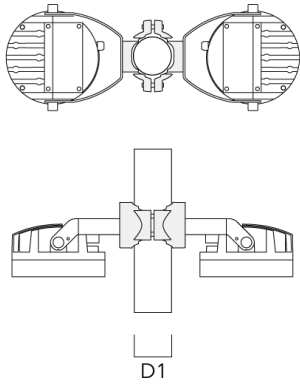

PC1 114-133/60 Pole clamp, single (Ø 4.5"-5.25")	139-2708	4.5-5.25	3.10
---	----------	----------	------

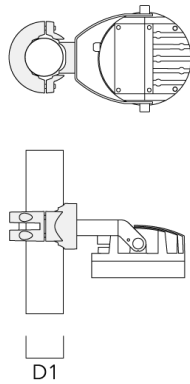

WE-EF LIGHTING USA, LLC

410-D Keystone Drive, 15086 Warrendale, PA 15086 - Phone: +1 724 742 0030

customersupport.usa@we-ef.com - <https://we-ef.com/us>

Subject to technical changes and errors. - Generated on 11/23/2024

139-1793

we-ef

FLC260 LED

Description	Part ID	D1	Weight (lb)
PC2 82-109/60 Pole clamp, double (Ø 3.25"-4.25")	139-2705	3.20-4.30	2.40

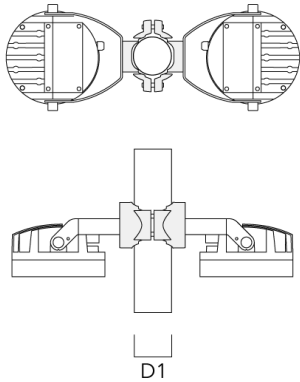

WE-EF LIGHTING USA, LLC

410-D Keystone Drive, 15086 Warrendale, PA 15086 - Phone: +1 724 742 0030
customersupport.usa@we-ef.com - <https://we-ef.com/us>
Subject to technical changes and errors. - Generated on 11/23/2024

139-1793

FLC260 LED

we-ef

Optical Accessories

Wallwash lens

Description	Part ID	C1
IO-20-FLC260-LED	139-1860	13.07

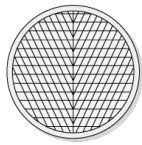

C1

WE-EF LIGHTING USA, LLC

410-D Keystone Drive, 15086 Warrendale, PA 15086 - Phone: +1 724 742 0030
customersupport.usa@we-ef.com - <https://we-ef.com/us>

Subject to technical changes and errors. - Generated on 11/23/2024

139-1793

FLC260 LED

we-ef

Linear spread lens

Description	Part ID	C1
IO-180-FLC260-LED	139-1861	13.07

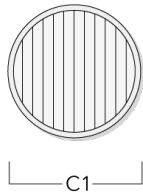

Softening Lens

Description	Part ID	C1
IO-360-FLC260-LED	139-1862	13.07

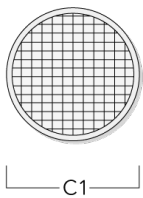

WE-EF LIGHTING USA, LLC

410-D Keystone Drive, 15086 Warrendale, PA 15086 - Phone: +1 724 742 0030

customersupport.usa@we-ef.com - <https://we-ef.com/us>

Subject to technical changes and errors. - Generated on 11/23/2024

139-1793

FLC260 LED

we-ef

Honeycomb louvre

Description	Part ID	C1
IW-360-FLC260-LED	139-1863	12.76

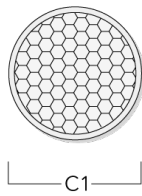

Snoot

Description	Part ID	A	C1
ET-FLC260-LED	139-1865	8.74	15.47

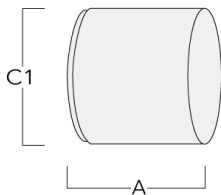

WE-EF LIGHTING USA, LLC

410-D Keystone Drive, 15086 Warrendale, PA 15086 - Phone: +1 724 742 0030
customersupport.usa@we-ef.com - <https://we-ef.com/us>

Subject to technical changes and errors. - Generated on 11/23/2024

139-1793

FLC260 LED

we-ef

Glare shield

Description	Part ID	A	C1
ES-FLC260-LED	139-1864	8.74	15.47

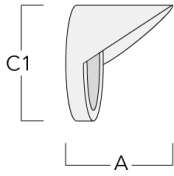

WE-EF LIGHTING USA, LLC

410-D Keystone Drive, 15086 Warrendale, PA 15086 - Phone: +1 724 742 0030
customersupport.usa@we-ef.com - <https://we-ef.com/us>

Subject to technical changes and errors. - Generated on 11/23/2024