



Description

IP66. Classe I. Classe II sur demande. IK07. Corps en fonte d'aluminium. Visserie inox avec traitement PCS. Protection contre la corrosion 5CE. Joint silicone CCG®. Verre de sécurité. Luminaire contrôlé via le protocole DALI en standard pour la version 1050mA. Version en 2200K disponible jusqu'à 1050mA, sauf pour la photométrie [EES]. À préciser lors de la demande de devis

Poids	17.50 kg
Distribution de la lumière	faisceau symétrique, intensif [E]
Source lumineuse	LED-36/108W / 1050 mA - 4000 K
IRC	80
Alimentation électrique	ballast électronique
LEDs	36
Rated input power	119 W
Flux lumineux nominal (lm)	
LED Lumen	450
Total Lumen	16200
Tj	85
Rated lumens (lm)	
LED Lumen	383.5
Total Lumen	13805
Ta	25

WE-EF Switzerland AG

Himmelrichstrasse 6, 6003 Luzern - Téléphone: +41 22 752 49 94
info.switzerland@we-ef.com - https://we-ef.com/ch_fr

Sous réserve de modifications techniques et d'erreurs. - Généré le 23/11/2024

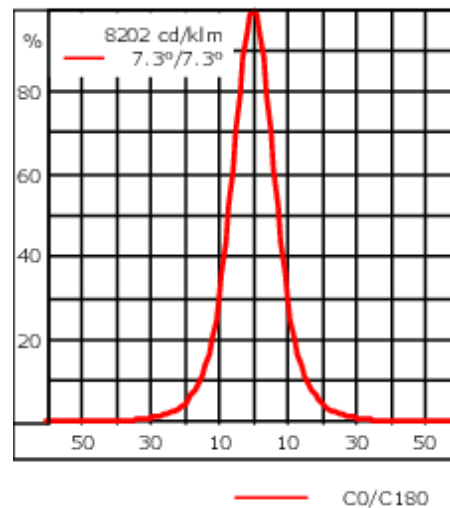
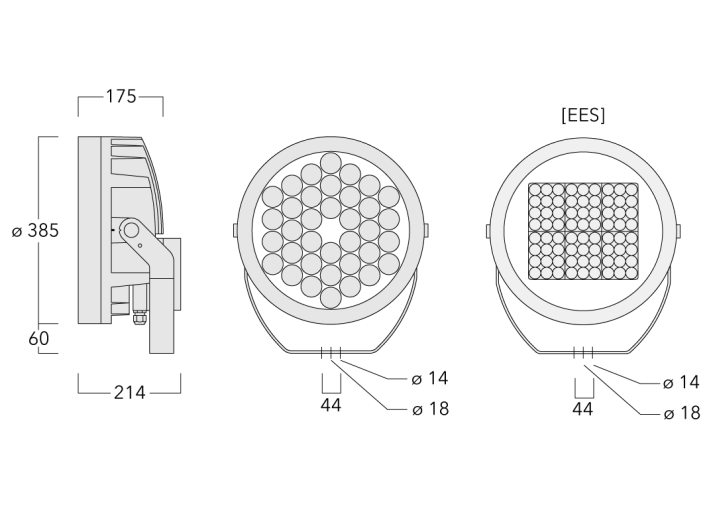

Spécifications

Description du matériel

Corps	Corps en fonte d'aluminium, visserie inox avec traitement PCS
Lentille	Verre de sécurité
Couleurs	<div style="display: flex; align-items: center;"> <div style="width: 20px; height: 15px; background-color: black; margin-right: 5px;"></div> RAL9004 Noir de sécurité </div> <div style="display: flex; align-items: center; margin-top: 5px;"> <div style="width: 20px; height: 15px; background-color: gray; margin-right: 5px;"></div> RAL9007 Aluminium gris </div> <div style="display: flex; align-items: center; margin-top: 5px;"> <div style="width: 20px; height: 15px; background-color: darkgray; margin-right: 5px;"></div> RAL7016 Gris anthracite </div> <div style="display: flex; align-items: center; margin-top: 5px;"> <div style="width: 20px; height: 15px; background-color: lightgray; margin-right: 5px;"></div> RAL9016 Blanc signalisation </div>
Joint	Joint silicone CCG®
IP	IP66
IK	IK07
Protection contre la corrosion	5CE
Surface exposée au vent	0.116 m ²

Description électrique

Alimentation électrique	220-240V / 50-60 Hz
Driver	Standard - version DALI disponible en option

Informations complémentaires

Durée de vie	Ta=25° L90B10 > 90000h
Classe d'efficacité énergétique	C-D

WE-EF Switzerland AG

Himmelrichstrasse 6, 6003 Luzern - Téléphone: +41 22 752 49 94

info.switzerland@we-ef.com - https://we-ef.com/ch_fr

Sous réserve de modifications techniques et d'erreurs. - Généré le 23/11/2024

Accessoires d'installation

Socle de montage EM

Description	Référence	D1	D2	H1	M1	Poids (kg)
EM1-M16 socle de montage	270-9038	160	130	203	9	2

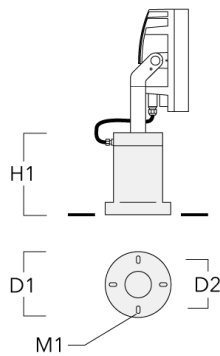

Base à enterrer

Description	Référence	D1	D2	D3	D4	H1	H2	M1	Poids (kg)
Base à enterrer ESV4	300-0461	145	130	102	108	400	350	8	7.05

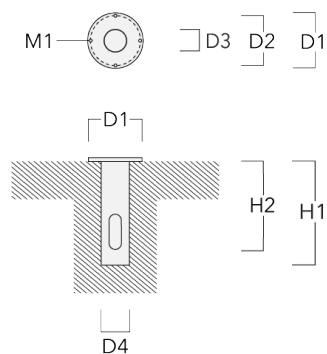

Traverse pour mâts

Description	Référence	A	C1	D x L1	Poids (kg)	D x S
TA2 traverse double (Ø 76 x 200)	147-0024		130	76 x 200	1.90	76 x 200

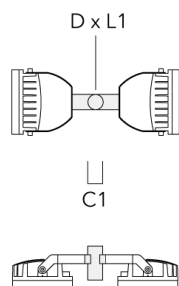

TA1 traverse simple (Ø 76 x 200)	147-0023		130	76 x 200	1.90	76 x 200
----------------------------------	----------	--	-----	----------	------	----------

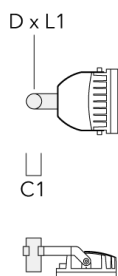

Description	Référence	A	C1	D x L1	Poids (kg)	D x S
TA2-L traverse longue orientable (Ø 76 x 200)	147-0105	±90°	420	76 x 200	16.10	76 x 200

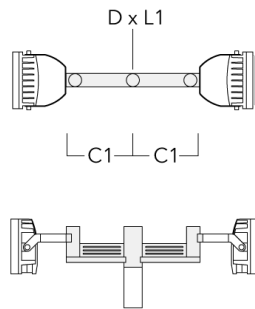

TA3 traverse triple orientable (Ø 89 x 200)	147-0025	±90°	650	89 x 200	17.90	89 x 200
---	----------	------	-----	----------	-------	----------

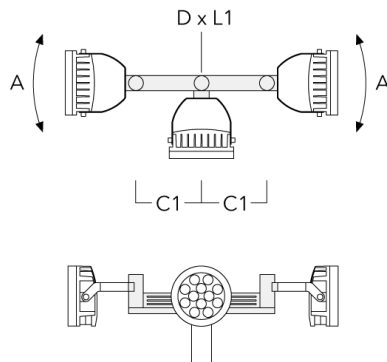

Description	Référence	A	C1	D x L1	Poids (kg)	D x S
TA4 Traverse pour 4 projecteurs (Ø 89 x 200)	147-0099	±90°	650	89 x 200	20.80	89 x 200

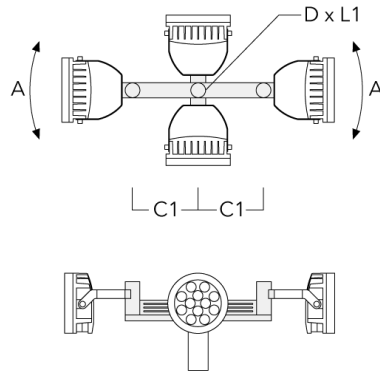

TA1 traverse simple (Ø 108 x 200)	147-0096		130	108 x 200	7.50	108 x 200
-----------------------------------	----------	--	-----	-----------	------	-----------

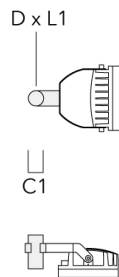

Description	Référence	A	C1	D x L1	Poids (kg)	D x S
TA2 traverse double (Ø 108 x 200)	147-0097		130	108 x 200	7.50	108 x 200

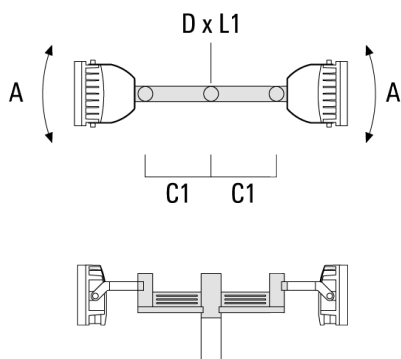

TA3 traverse triple orientable (Ø 108 x 200 x 200)	147-0098	$\pm 90^\circ$	650	108 x 200	24.20	108 x 200
--	----------	----------------	-----	-----------	-------	-----------

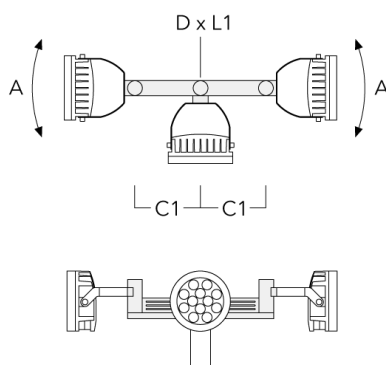

Collier pour mâts TS

Description	Référence	D1	Poids (kg)	D
TS1-2/M12 collier simple pour tube (Ø 102-114)	147-0526	102-114	1.50	102-114

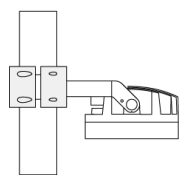
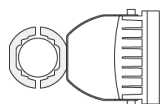

D1

TS1-2/M12 collier simple pour tube (Ø 76-89)	147-0543	76-89	1.40	76-89
--	----------	-------	------	-------

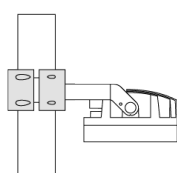
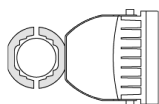

D1

Description	Référence	D1	Poids (kg)	D
TS1-2/M12 collier simple pour tube (Ø 114-133)	147-0544	114-133	1.70	114-133

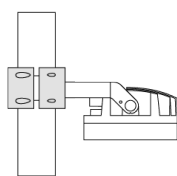
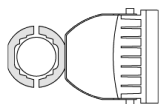

D1

TS2-2/M12 collier double pour tube (Ø 76-89)	147-0545	76-89	1.40	76-89
---	----------	-------	------	-------

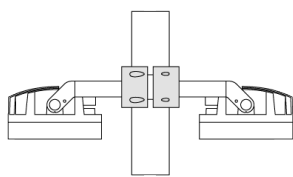
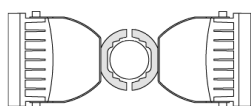

D1

Description	Référence	D1	Poids (kg)	D
TS2-2/M12 collier double pour tube (Ø 102-114)	147-0527	102-114	1.50	102-114

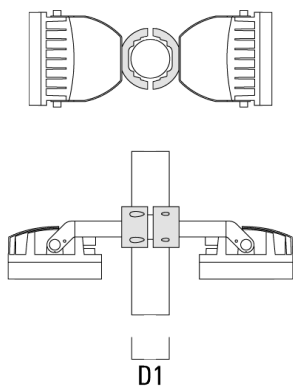

TS2-2/M12 collier double pour tube (Ø 114-133)	147-0546	114-133	1.60	114-133
---	----------	---------	------	---------

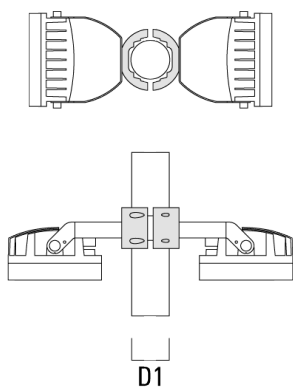

Collier pour mâts PC

Description	Référence	D1	Poids (kg)
PC2 76-89/60 collier double pour tube (Ø 76-89)	139-2703	76-89	1.00

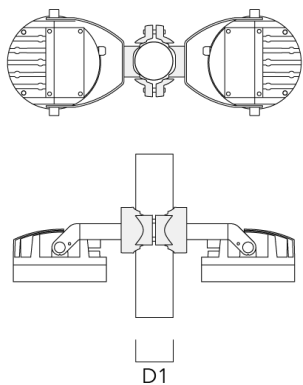

PC1 76-89/60 collier simple (Ø 76-89)	139-2702	76-89	1.00
---------------------------------------	----------	-------	------

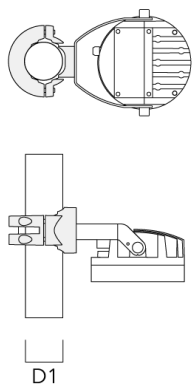

Description	Référence	D1	Poids (kg)
PC2 102-114/60 collier double pour tube (Ø 102-114)	139-2707	102-114	1.20

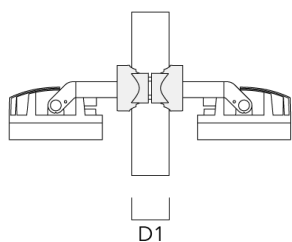
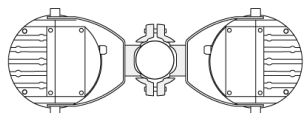

PC1 102-114/60 collier simple (Ø 102-114)	139-2706	102-114	1.20
---	----------	---------	------

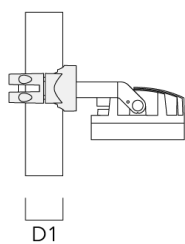
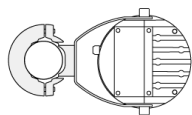

Description	Référence	D1	Poids (kg)
PC2 114-133/60 collier double pour tube (Ø 114-133)	139-2709	114-133	1.40

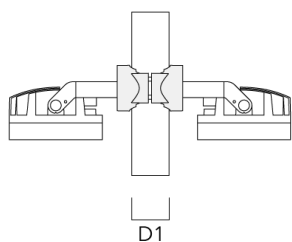
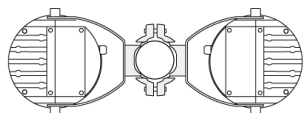

PC1 114-133/60 collier simple (Ø 114-133)	139-2708	114-133	1.40
---	----------	---------	------

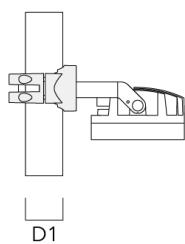
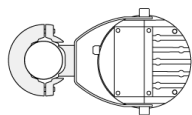

139-1794

FLC260 LED

we-ef

Description	Référence	D1	Poids (kg)
PC2 82-109/60 collier double pour tube (Ø 82-109)	139-2705	82-109	1.10

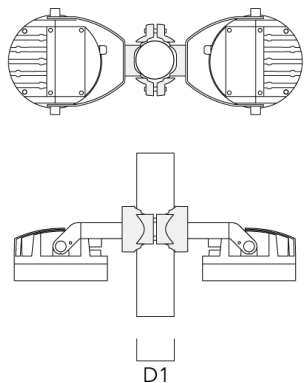

Control**Eco Step Dim® Basic**

Description	Référence
Eco Step Dim® Basic LED	430-0001

Eco Step Dim® Advanced

Description	Référence
Eco Step Dim® Advanced LED	430-0002

R2C Ready to Connect

Description	Référence
R2C Ready to Connect (top)	430-0019

Accessoires Optiques

Lentille ovalisante

Description	Référence	C1
IO-180-FLC260-LED	139-1861	332

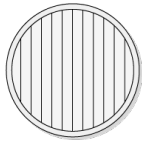

C1

Lentille élargissante

Description	Référence	C1
IO-360-FLC260-LED	139-1862	332

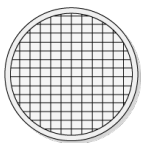

C1

Grille nid d'abeille

Description	Référence	C1
IW-03-FLC260-LED - [E][EE][EES]	139-1863	324

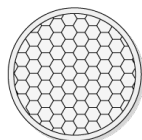

C1

Canon anti-éblouissement

Description	Référence	A	C1
ET-FLC260-LED	139-1865	222	393

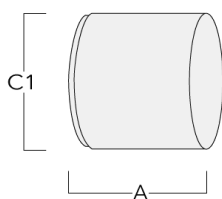

Visière

Description	Référence	A	C1
ES-FLC260-LED	139-1864	222	393

