



Description

IP66. Classe I. Classe II sur demande. IK07. Corps en fonte d'aluminium. Visserie inox avec traitement PCS. Protection contre la corrosion 5CE. Joint silicone CCG®. Verre de sécurité. Luminaire contrôlé via le protocole DALI en standard pour la version 1050mA. Version en 2200K disponible jusqu'à 1050mA, sauf pour la photométrie [EES]. À préciser lors de la demande de devis

Poids	17.50 kg
Distribution de la lumière	faisceau symétrique, ultra intensif [EE]
Source lumineuse	LED-36/108W / 1050 mA - 4000 K
IRC	80
Alimentation électrique	ballast électronique
LEDs	36
Rated input power	119 W

Flux lumineux nominal (lm)

LED Lumen	450
Total Lumen	16200
Tj	85

Rated lumens (lm)

LED Lumen	403.5
Total Lumen	14526.6
Ta	25

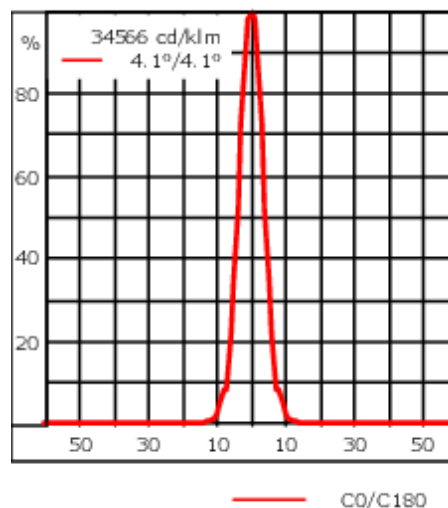
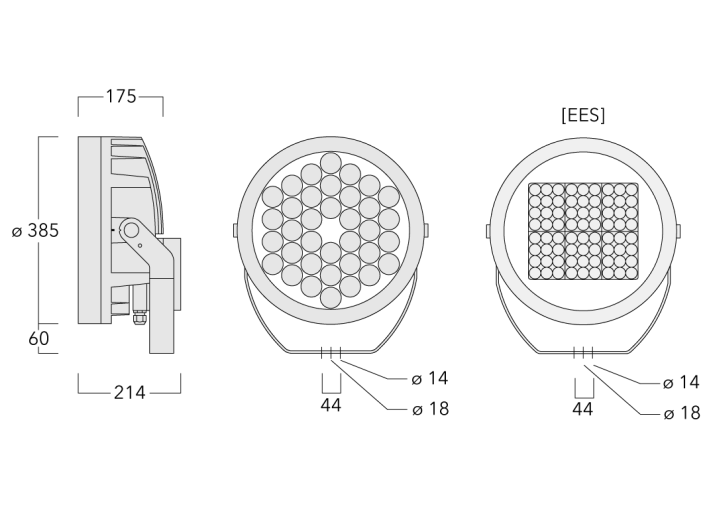

Spécifications

Description du matériel

Corps	Corps en fonte d'aluminium, visserie inox avec traitement PCS
Lentille	Verre de sécurité
Couleurs	<div style="display: flex; align-items: center;"> <div style="width: 20px; height: 15px; background-color: black; margin-right: 5px;"></div> RAL9004 Noir de sécurité </div> <div style="display: flex; align-items: center; margin-top: 5px;"> <div style="width: 20px; height: 15px; background-color: gray; margin-right: 5px;"></div> RAL9007 Aluminium gris </div> <div style="display: flex; align-items: center; margin-top: 5px;"> <div style="width: 20px; height: 15px; background-color: darkgray; margin-right: 5px;"></div> RAL7016 Gris anthracite </div> <div style="display: flex; align-items: center; margin-top: 5px;"> <div style="width: 20px; height: 15px; background-color: lightgray; margin-right: 5px;"></div> RAL9016 Blanc signalisation </div>
Joint	Joint silicone CCG®
IP	IP66
IK	IK07
Protection contre la corrosion	5CE
Surface exposée au vent	0.116 m ²

Description électrique

Alimentation électrique	220-240V / 50-60 Hz
Driver	Standard - version DALI disponible en option

Informations complémentaires

Durée de vie	Ta=25° L90B10 > 90000h
Classe d'efficacité énergétique	C-D

WE-EF Switzerland AG

Himmelrichstrasse 6, 6003 Luzern - Téléphone: +41 22 752 49 94

info.switzerland@we-ef.com - https://we-ef.com/ch_fr

Sous réserve de modifications techniques et d'erreurs. - Généré le 23/11/2024

Accessoires d'installation

Socle de montage EM

Description	Référence	D1	D2	H1	M1	Poids (kg)
EM1-M16 socle de montage	270-9038	160	130	203	9	2

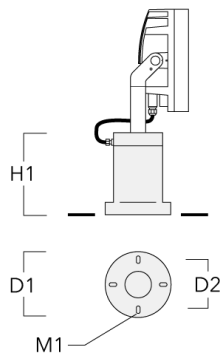

Base à enterrer

Description	Référence	D1	D2	D3	D4	H1	H2	M1	Poids (kg)
Base à enterrer ESV4	300-0461	145	130	102	108	400	350	8	7.05

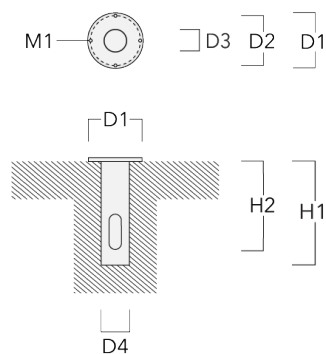

Traverse pour mâts

Description	Référence	A	C1	D x L1	Poids (kg)	D x S
TA2 traverse double (Ø 76 x 200)	147-0024		130	76 x 200	1.90	76 x 200

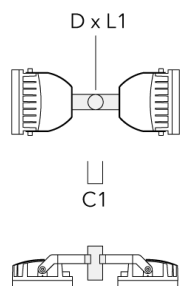

TA1 traverse simple (Ø 76 x 200)	147-0023		130	76 x 200	1.90	76 x 200
----------------------------------	----------	--	-----	----------	------	----------

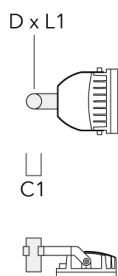

Description	Référence	A	C1	D x L1	Poids (kg)	D x S
TA2-L traverse longue orientable (Ø 76 x 200)	147-0105	±90°	420	76 x 200	16.10	76 x 200

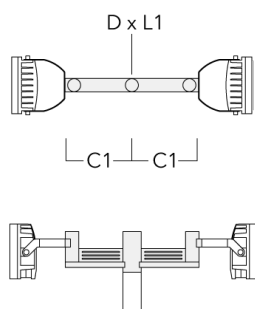

TA3 traverse triple orientable (Ø 89 x 200)	147-0025	±90°	650	89 x 200	17.90	89 x 200
---	----------	------	-----	----------	-------	----------

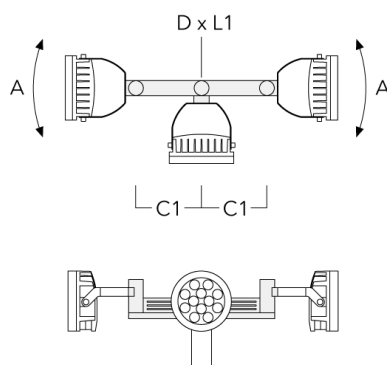

Description	Référence	A	C1	D x L1	Poids (kg)	D x S
TA4 Traverse pour 4 projecteurs (Ø 89 x 200)	147-0099	±90°	650	89 x 200	20.80	89 x 200

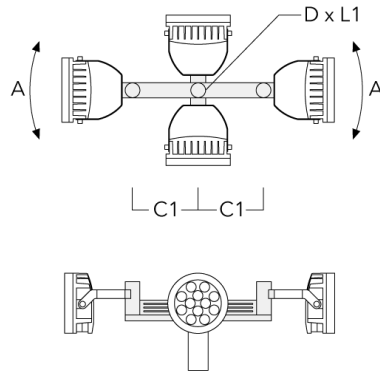

TA1 traverse simple (Ø 108 x 200)	147-0096		130	108 x 200	7.50	108 x 200
-----------------------------------	----------	--	-----	-----------	------	-----------

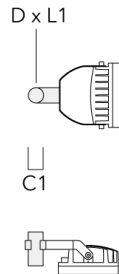

Description	Référence	A	C1	D x L1	Poids (kg)	D x S
TA2 traverse double (Ø 108 x 200)	147-0097		130	108 x 200	7.50	108 x 200

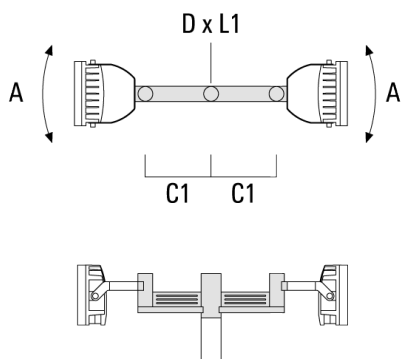

TA3 traverse triple orientable (Ø 108 x 200)	147-0098	$\pm 90^\circ$	650	108 x 200	24.20	108 x 200
--	----------	----------------	-----	-----------	-------	-----------

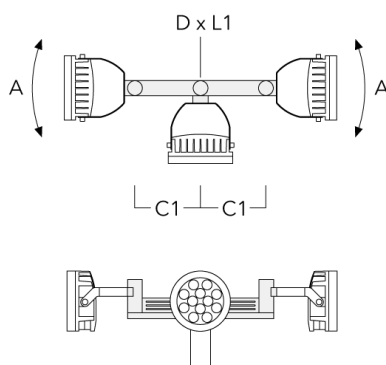

Collier pour mâts TS

Description	Référence	D1	Poids (kg)	D
TS1-2/M12 collier simple pour tube (Ø 102-114)	147-0526	102-114	1.50	102-114

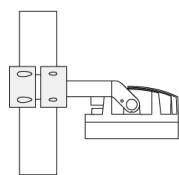
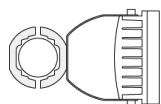

D1

TS1-2/M12 collier simple pour tube (Ø 76-89)	147-0543	76-89	1.40	76-89
--	----------	-------	------	-------

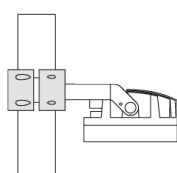
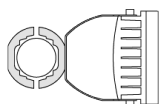

D1

Description	Référence	D1	Poids (kg)	D
TS1-2/M12 collier simple pour tube (Ø 114-133)	147-0544	114-133	1.70	114-133

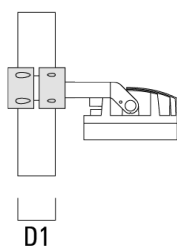
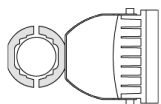

TS2-2/M12 collier double pour tube (Ø 76-89)	147-0545	76-89	1.40	76-89
---	----------	-------	------	-------

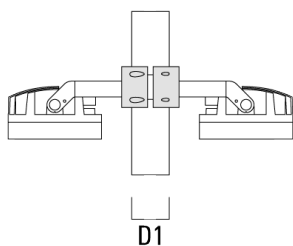
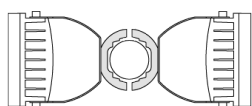

Description	Référence	D1	Poids (kg)	D
TS2-2/M12 collier double pour tube (Ø 102-114)	147-0527	102-114	1.50	102-114

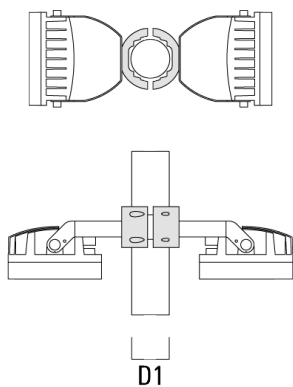

TS2-2/M12 collier double pour tube (Ø 114-133)	147-0546	114-133	1.60	114-133
---	----------	---------	------	---------

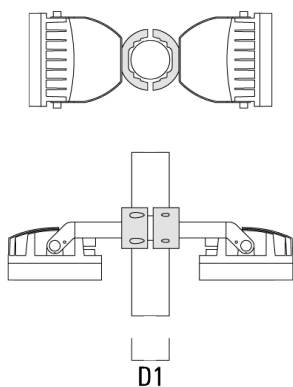

Collier pour mâts PC

Description	Référence	D1	Poids (kg)
PC2 76-89/60 collier double pour tube (Ø 76-89)	139-2703	76-89	1.00

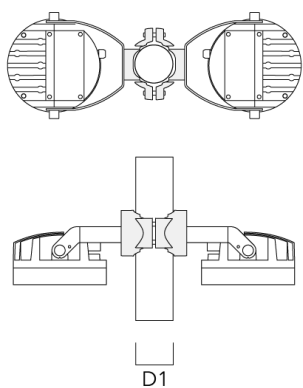

PC1 76-89/60 collier simple (Ø 76-89)	139-2702	76-89	1.00
---------------------------------------	----------	-------	------

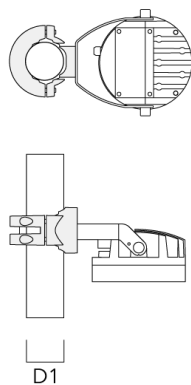

Description	Référence	D1	Poids (kg)
PC2 102-114/60 collier double pour tube (Ø 102-114)	139-2707	102-114	1.20

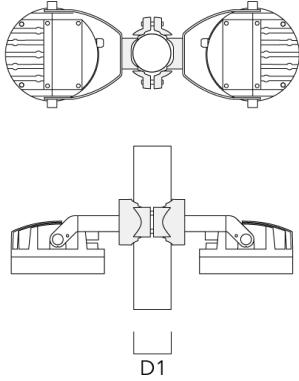

PC1 102-114/60 collier simple (Ø 102-114)	139-2706	102-114	1.20
---	----------	---------	------

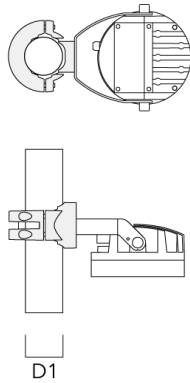

Description	Référence	D1	Poids (kg)
PC2 114-133/60 collier double pour tube (Ø 114-133)	139-2709	114-133	1.40

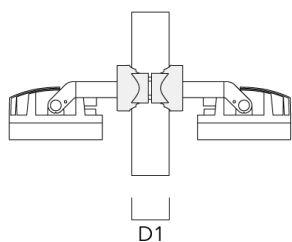
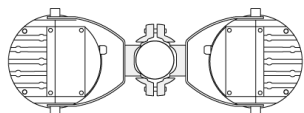

PC1 114-133/60 collier simple (Ø 114-133)	139-2708	114-133	1.40
---	----------	---------	------

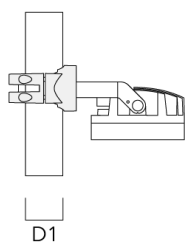
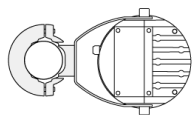

Description	Référence	D1	Poids (kg)
PC2 82-109/60 collier double pour tube (Ø 82-109)	139-2705	82-109	1.10

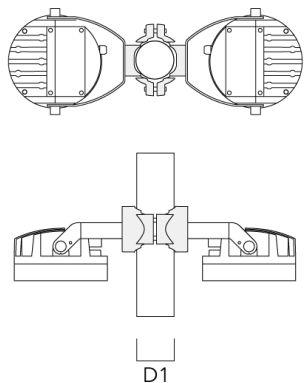

Control**Eco Step Dim® Basic**

Description	Référence
Eco Step Dim® Basic LED	430-0001

Eco Step Dim® Advanced

Description	Référence
Eco Step Dim® Advanced LED	430-0002

R2C Ready to Connect

Description	Référence
R2C Ready to Connect (top)	430-0019

Accessoires Optiques

Lentille ovalisante

Description	Référence	C1
IO-180-FLC260-LED	139-1861	332

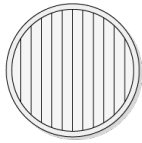

C1

Lentille élargissante

Description	Référence	C1
IO-360-FLC260-LED	139-1862	332

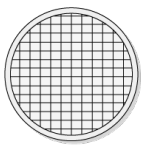

C1

Grille nid d'abeille

Description	Référence	C1
IW-03-FLC260-LED - [E][EE][EES]	139-1863	324

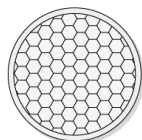

C1

Canon anti-éblouissement

Description	Référence	A	C1
ET-FLC260-LED	139-1865	222	393

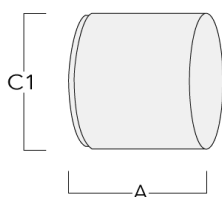

Visière

Description	Référence	A	C1
ES-FLC260-LED	139-1864	222	393

