

139-1877

FLC240-CC LED

we-ef



Description

RGBW/RGBA Colour Changer. IP66, Class I. IK07. Marine-grade, die-cast aluminium alloy. 5CE superior corrosion protection + primer including PCS hardware. Silicone CCG® Controlled Compression Gasket. Safety glass lens. Two cable glands for improved wiring flexibility. Integral EC electronic converter, thermally separated. CAD-optimised optics for superior illumination and glare control. OLC® One LED Concept. Factory installed LED circuit board. DMX interface. M20 cable gland for network- and DMX-connection, WE-EF recommend a multi core cable for DMX & Power "Power PUR-SR 3x1,5 + DMX". Separation of DMX and Power supply on request.

Weight	13.80 kg
Light distribution	symmetric, medium beam [M]
Light source	LED-24/96W - RGBW/4K
CRI	20/80
Power supply	EC
LEDs	24
Rated input power	100 W
Nominal Lumen (lm)	
LED Lumen	340
Total Lumen	8160
Tj	85
Rated lumens (lm)	
LED Lumen	267.1
Total Lumen	6409.9
Ta	25

WE-EF LIGHTING Pty Ltd

47 Tarnard Drive, 3195 Braeside, Victoria - Phone: +61 3 8587 0444 - Fax: +61 3 8587 0499
info.australia@we-ef.com - <https://we-ef.com/aus>

Subject to technical changes and errors. - Generated on 10/03/2025

139-1877

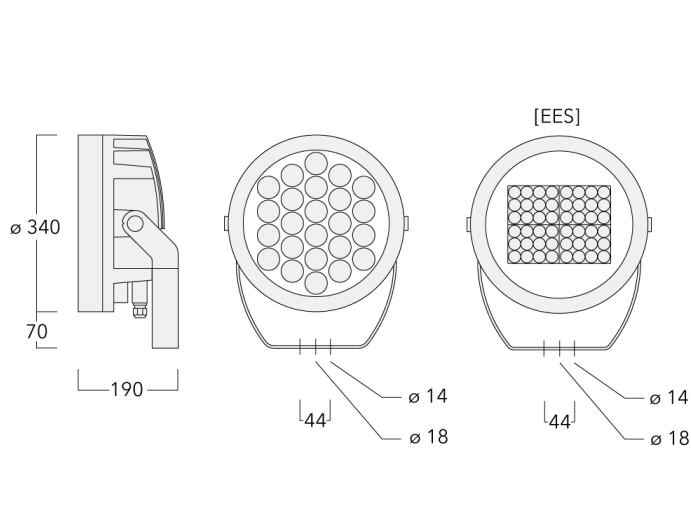

FLC240-CC LED

we-ef



Specifications

Material description

Body	Marine-grade, die-cast aluminium alloy
Lens	Safety glass lens
Colours	 RAL9004 Signal black  RAL9006 White aluminium  RAL9007 Grey aluminium
Gasket	Silicone CCG® Controlled Compression Gasket
Fasteners	PCS Polymer Coated Stainless Steel Hardware (unpainted)
Ingress protection	IP66
Impact resistance	IK07
Corrosion resistance	5CE+Primer
Windage	0.090 m ²

Electrical description

Power supply	230V / 50 Hz
Driver / Ballast	Integral EC electronic converter in thermally-separated compartment
Power factor	> 0.9
Surge protection	1/2 kV (optional SP10)

Additional information

Lifetime	Ta=40° L90B10 > 90000h
Warranty	The product is supplied with 10-year warranty. Please refer to the LED Warranty Statement located on www.we-ef.com for further details.

WE-EF LIGHTING Pty Ltd

47 Tarnard Drive, 3195 Braeside, Victoria - Phone: +61 3 8587 0444 - Fax: +61 3 8587 0499

info.australia@we-ef.com - <https://we-ef.com/aus>

Subject to technical changes and errors. - Generated on 10/03/2025

Mounting Accessories

Floodlight mounting bracket TA

Description	Part ID	A	C1	D × L1	Weight (kg)	D × S
TA1 Mounting bracket, single* (Ø 76 x 200)	147-0023		130	76 x 200	1.90	76 x 200

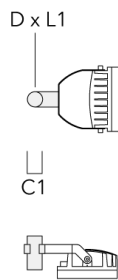

TA2 Mounting bracket, double* (Ø 76 x 200)	147-0024		130	76 x 200	1.90	76 x 200
--	----------	--	-----	----------	------	----------

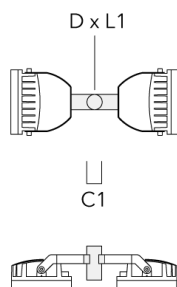

FLC240-CC LED

Description	Part ID	A	C1	D x L1	Weight (kg)	D x S
TA2-L Mounting bracket, double (Ø 76 x 200)	147-0105	±90°	420	76 x 200	16.10	76 x 200

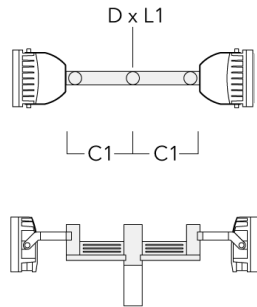

TA3 Mounting bracket, triple (Ø 89 x 200)	147-0025	±90°	650	89 x 200	17.90	89 x 200
---	----------	------	-----	----------	-------	----------

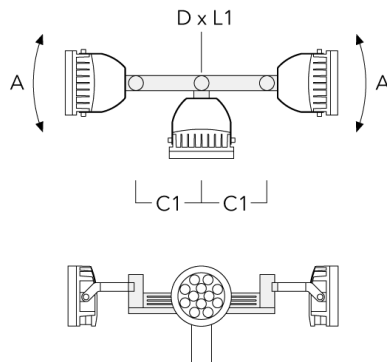

139-1877

we-ef

FLC240-CC LED

Description	Part ID	A	C1	D x L1	Weight (kg)	D x S
TA4 Mounting bracket, quad (Ø 89 x 200)	147-0099	±90°	650	89 x 200	20.80	89 x 200



TA1 Mounting bracket, single (Ø 108 x 200)	147-0096		130	108 x 200	7.50	108 x 200
--	----------	--	-----	-----------	------	-----------

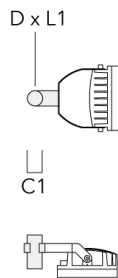

WE-EF LIGHTING Pty Ltd

47 Tarnard Drive, 3195 Braeside, Victoria - Phone: +61 3 8587 0444 - Fax: +61 3 8587 0499

info.australia@we-ef.com - <https://we-ef.com/aus>

Subject to technical changes and errors. - Generated on 10/03/2025

FLC240-CC LED

Description	Part ID	A	C1	D × L1	Weight (kg)	D × S
TA2 Mounting bracket, double (Ø 108 x 200)	147-0097		130	108 x 200	7.50	108 x 200

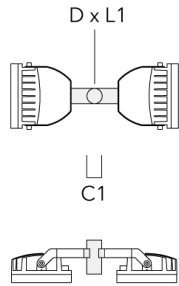

TA2-L Mounting bracket, double (Ø 108 x 200)	147-0148	±90°	420	108 x 200	20.20	108 x 200
--	----------	------	-----	-----------	-------	-----------

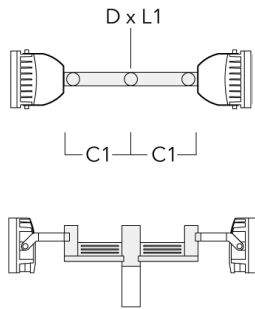

139-1877

FLC240-CC LED

we-ef

Description	Part ID	A	C1	D x L1	Weight (kg)	D x S
TA3 Mounting bracket, triple (Ø 108 x 200)	147-0098	±90°	650	108 x 200	24.20	108 x 200



TA4 Mounting bracket, quad (Ø 108 x 200)	147-0100	±90°	650	108 x 200	24.20	108 x 200
--	----------	------	-----	-----------	-------	-----------



WE-EF LIGHTING Pty Ltd

47 Tarnard Drive, 3195 Braeside, Victoria - Phone: +61 3 8587 0444 - Fax: +61 3 8587 0499

info.australia@we-ef.com - <https://we-ef.com/aus>

Subject to technical changes and errors. - Generated on 10/03/2025

Planted root

Description	Part ID	D1	D2	D3	D4	H1	H2	M1	T1	T2	Weight (kg)
Planted root ESV4	300-0461-AP	150	130	60	89	400	350	8	200	50 x 100	3.85

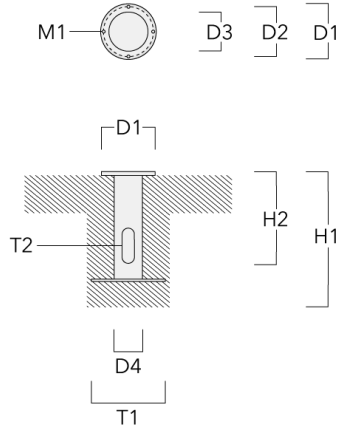

Spigot cap KF

Description	Part ID	D1	Weight (kg)
KF1-M16 Spigot Cap (ø 60 x 100)	310-9120	60 x 100	1.40

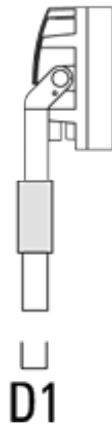

139-1877

FLC240-CC LED

we-ef

Description	Part ID	D1	Weight (kg)
KF1-M16 Spigot Cap (ø 76 x 100)	310-9121	76 x 100	2.2

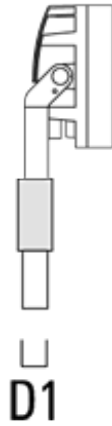

Pole clamp PC - Rotatable

Description	Part ID	D1	Weight (kg)
PC2 76-89/60 Pole clamp, double (Ø 76-89)	139-2703	76-89	1.00

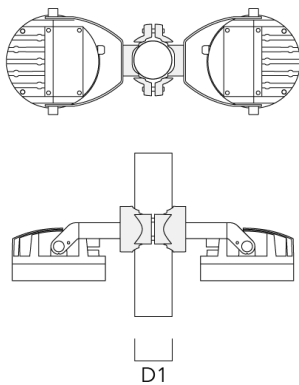

WE-EF LIGHTING Pty Ltd

47 Tarnard Drive, 3195 Braeside, Victoria - Phone: +61 3 8587 0444 - Fax: +61 3 8587 0499

info.australia@we-ef.com - <https://we-ef.com/aus>

Subject to technical changes and errors. - Generated on 10/03/2025

139-1877

we-ef

FLC240-CC LED

Description	Part ID	D1	Weight (kg)
PC1 76-89/60 Pole clamp, single (Ø 76-89)	139-2702	76-89	1.00

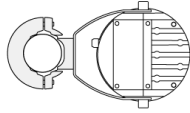

PC2 102-114/60 Pole clamp, double (Ø 102-114)	139-2707	102-114	1.20
---	----------	---------	------

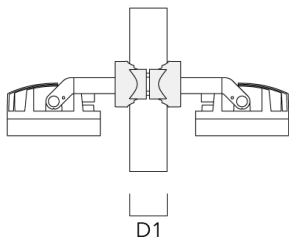
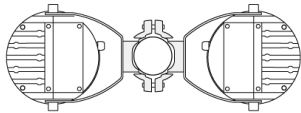

WE-EF LIGHTING Pty Ltd

47 Tarnard Drive, 3195 Braeside, Victoria - Phone: +61 3 8587 0444 - Fax: +61 3 8587 0499

info.australia@we-ef.com - <https://we-ef.com/aus>

Subject to technical changes and errors. - Generated on 10/03/2025

FLC240-CC LED

Description	Part ID	D1	Weight (kg)
PC1 102-114/60 Pole clamp, single (Ø 102-114)	139-2706	102-114	1.20

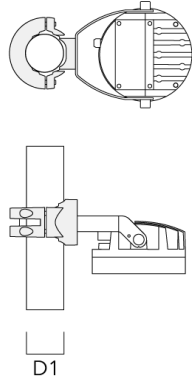

PC2 114-133/60 Pole clamp, double (Ø 114-133)	139-2709	114-133	1.40
--	----------	---------	------

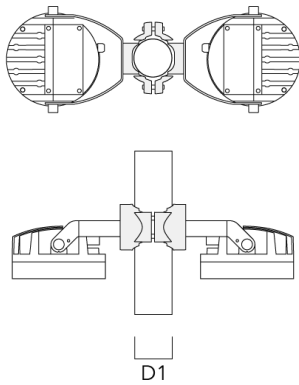

139-1877

we-ef

FLC240-CC LED

Description	Part ID	D1	Weight (kg)
PC1 114-133/60 Pole clamp, single (Ø 114-133)	139-2708	114-133	1.40



PC2 82-109/60 Pole camp, double (Ø 82-109)	139-2705	82-109	1.10
---	----------	--------	------



WE-EF LIGHTING Pty Ltd

47 Tarnard Drive, 3195 Braeside, Victoria - Phone: +61 3 8587 0444 - Fax: +61 3 8587 0499

info.australia@we-ef.com - <https://we-ef.com/aus>

Subject to technical changes and errors. - Generated on 10/03/2025

139-1877

FLC240-CC LED

we-ef

Description	Part ID	D1	Weight (kg)
PC1 82-109/60 Pole camp, single (Ø 82-109)	139-2704	82-109	1.10

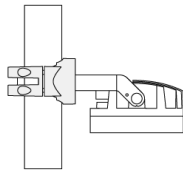

D1

WE-EF LIGHTING Pty Ltd

47 Tarnard Drive, 3195 Braeside, Victoria - Phone: +61 3 8587 0444 - Fax: +61 3 8587 0499

info.australia@we-ef.com - <https://we-ef.com/aus>

Subject to technical changes and errors. - Generated on 10/03/2025

139-1877

FLC240-CC LED

we-ef

Optical Accessories

Wallwash lens

Description	Part ID	Additional information	C1
IO-20-FLC240-LED	139-1854	for symmetric [M] medium beam luminaire only	289

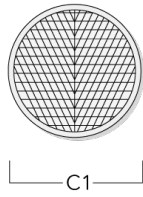

Linear spread lens

Description	Part ID	C1
Linear spread lens IO-180	139-1855	289

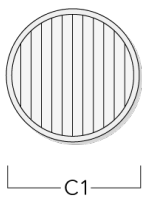

WE-EF LIGHTING Pty Ltd

47 Tarnard Drive, 3195 Braeside, Victoria - Phone: +61 3 8587 0444 - Fax: +61 3 8587 0499

info.australia@we-ef.com - <https://we-ef.com/aus>

Subject to technical changes and errors. - Generated on 10/03/2025

Snoot

Description	Part ID	A	C1
ET-FLC240-LED	139-1859	200	346

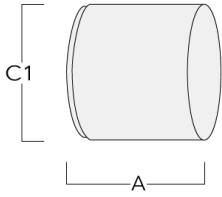

Glare shield

Description	Part ID	A	C1
ES-FLC240-LED	139-1858	200	346

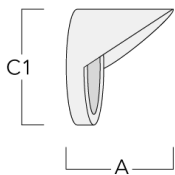

139-1877

FLC240-CC LED

we-ef

Surface wash lens

Description	Part ID	C1
IO-360-FLC240-LED	139-1856	289

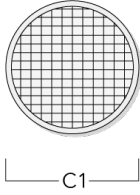

Honeycomb louvre

Description	Part ID	C1
Honeycomb Louvre IW	139-1857	279

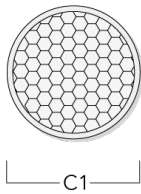

WE-EF LIGHTING Pty Ltd

47 Tarnard Drive, 3195 Braeside, Victoria - Phone: +61 3 8587 0444 - Fax: +61 3 8587 0499

info.australia@we-ef.com - <https://we-ef.com/aus>

Subject to technical changes and errors. - Generated on 10/03/2025

Control**DMX Controller**

Description	Part ID
DMX Controller	400-0469

DMX Controller (smart)

Description	Part ID	Additional information
DMX Controller (smart)	400-0470	IP20. The Touch Panel is an intuitive and easy-to-use keypad or one DMX universe. It can store up to 36 scenes; alternatively, via



DMX Controller - RDM ready

Description	Part ID
DMX Controller - RDM ready	400-0471

**DMX Splitter**

Description	Part ID
DMX Splitter	400-0473



139-1877

FLC240-CC LED

we-ef

DMX Booster Box

Description	Part ID
DMX Booster Box	400-0474



DMX Motion Sensor

Description	Part ID
DMX Motion Sensor	400-0478



WE-EF LIGHTING Pty Ltd

47 Tarnard Drive, 3195 Braeside, Victoria - Phone: +61 3 8587 0444 - Fax: +61 3 8587 0499

info.australia@we-ef.com - <https://we-ef.com/aus>

Subject to technical changes and errors. - Generated on 10/03/2025

DMX Termination Plug

Description	Part ID
DMX Termination Plug	400-0475



DMX Plug and Socket

Description	Part ID
DMX Plug and Socket	400-0479



DMX Combination Cable

Description	Part ID
DMX Combination Cable	400-0480

**DMX Controller (smart) - RDM ready**

Description	Part ID
DMX Controller (smart) - RDM ready	400-0472

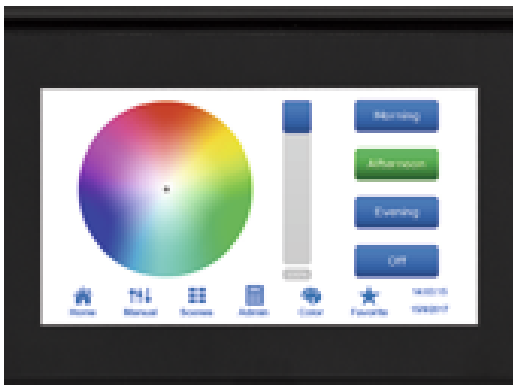
**R2C Ready to Connect**

Description	Part ID
R2C Ready to Connect (top)	430-0019

WE-EF LIGHTING Pty Ltd

47 Tarnard Drive, 3195 Braeside, Victoria - Phone: +61 3 8587 0444 - Fax: +61 3 8587 0499

info.australia@we-ef.com - <https://we-ef.com/aus>

Subject to technical changes and errors. - Generated on 10/03/2025

139-1877

FLC240-CC LED

we-ef

DMX Wireless Antenna

Description	Part ID
Antenna RF1.8dB	430-0018

WE-EF LIGHTING Pty Ltd

47 Tarnard Drive, 3195 Braeside, Victoria - Phone: +61 3 8587 0444 - Fax: +61 3 8587 0499

info.australia@we-ef.com - <https://we-ef.com/aus>

Subject to technical changes and errors. - Generated on 10/03/2025