

117-0224

ZFY230 LED - 600 mm

**we-ef**



#### Description

IP66. IK10. Marine-grade, all-aluminium construction. 5CE superior corrosion protection + primer including PCS hardware. Polycarbonate lens. Silicone CCG\_R\_C Controlled Compression Gasket. Luminaire is factory-sealed and does not need to be opened during installation.

Integral EC electronic converter in thermally-separated compartment. Advanced thermal management protects LEDs while optimising lumens output. CAD-optimised optics for superior illumination and glare control.

Weight	7.80 kg
Light distribution	symmetric distribution [C60]
Light source	LED-FT-12W / 350 mA - 4000 K
CRI	80
Power supply	EC
LEDs	1
Rated input power	14 W
<b>Rated lumens (lm)</b>	
LED Lumen	799.4
Total Lumen	799.4
Ta	25
<b>Nominal Lumen (lm)</b>	
LED Lumen	2160
Total Lumen	2160
Tc	25

#### WE-EF LIGHTING Pty Ltd

47 Tarnard Drive, 3195 Braeside, Victoria - Phone: +61 3 8587 0444 - Fax: +61 3 8587 0499

info.australia@we-ef.com - <https://we-ef.com/aus>

Subject to technical changes and errors. - Generated on 19/04/2025

117-0224

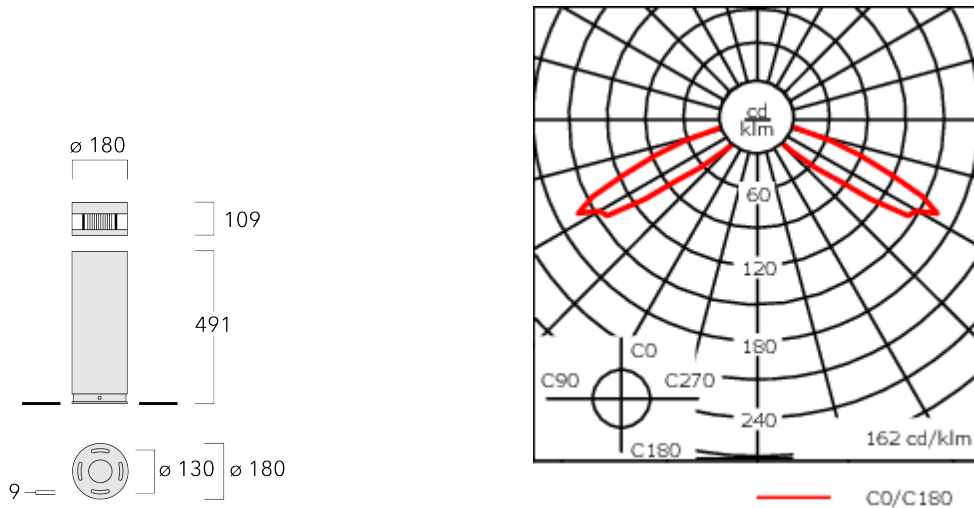

ZFY230 LED - 600 mm

**we-ef**



## Specifications

### Material description

Body	Marine-grade, all-aluminium construction
Lens	Polycarbonate lens
Colours	 RAL9004 Signal black  RAL9006 White aluminium  RAL9007 Grey aluminium
Gasket	Silicone CCG® Controlled Compression Gasket
Fasteners	PCS Polymer Coated Stainless Steel Hardware (unpainted)
Ingress protection	IP66
Impact resistance	IK10
Corrosion resistance	5CE+Primer

### Electrical description

Power supply	230V / 50 Hz
Driver / Ballast	Integral EC electronic converter
Surge protection	10/10kV (SP10) available on request

### Additional information

Lifetime	Ta=40° L70B50 > 50000h
Warranty	The product is supplied with 10-year warranty. Please refer to the LED Warranty Statement located on <a href="http://www.we-ef.com">www.we-ef.com</a> for further details.

#### WE-EF LIGHTING Pty Ltd

47 Tarnard Drive, 3195 Braeside, Victoria - Phone: +61 3 8587 0444 - Fax: +61 3 8587 0499

info.australia@we-ef.com - <https://we-ef.com/aus>

Subject to technical changes and errors. - Generated on 19/04/2025

**117-0224**

**ZFY230 LED - 600 mm**

**we-ef**

## **Control**

### **1-10 V analogue dimming interface**

---

Description	Part ID	C
1-10 V analogue dimming interface	430-0011	90

---

**WE-EF LIGHTING Pty Ltd**

47 Tarnard Drive, 3195 Braeside, Victoria - Phone: +61 3 8587 0444 - Fax: +61 3 8587 0499  
info.australia@we-ef.com - <https://we-ef.com/aus>

Subject to technical changes and errors. - Generated on 19/04/2025

**DALI interface**

---

Description	Part ID	Additional information	C
DALI interface	430-0013	DALI variant. The luminaire is equipped with a DT6 Dali driver (Dali 2.0).	90

---

## Dali 2.0

- Application controllers and Input devices defined
- Single-masters and multi-masters allowed
- Event priorities defined
- Separate addressing & grouping from control gear

Note: Mixing Dali 1 and Dali 2.0 drivers can cause problems because the addressing and the command scope has changed!

117-0224

**we-ef**

ZFY230 LED - 600 mm

**Eco Step Dim® Motion**

---

Description	Part ID
Eco Step Dim® Motion - Linked-Primary	430-0030

---

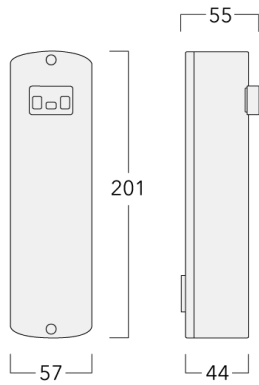

---

Eco Step Dim® Motion - Linked-Secondary	430-0031
-----------------------------------------	----------

---

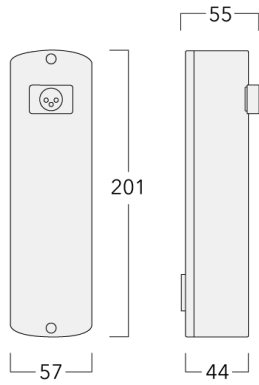

**WE-EF LIGHTING Pty Ltd**

47 Tarnard Drive, 3195 Braeside, Victoria - Phone: +61 3 8587 0444 - Fax: +61 3 8587 0499

info.australia@we-ef.com - <https://we-ef.com/aus>

Subject to technical changes and errors. - Generated on 19/04/2025

**117-0224**

**ZFY230 LED - 600 mm**

**we-ef**

---

Description	Part ID
Eco Step Dim® Motion - Stand-Alone	430-0037

---



**WE-EF LIGHTING Pty Ltd**

47 Tarnard Drive, 3195 Braeside, Victoria - Phone: +61 3 8587 0444 - Fax: +61 3 8587 0499

info.australia@we-ef.com - <https://we-ef.com/aus>

Subject to technical changes and errors. - Generated on 19/04/2025

117-0224

ZFY230 LED - 600 mm

## Mounting Accessories

### Planted root

Description	Part ID	D1	D2	D3	D4	H1	H2	M1	T1	T2	Weight (kg)
Planted root ESV4	300-0461-AP	150	130	60	89	400	350	8	200	50 x 100	3.85

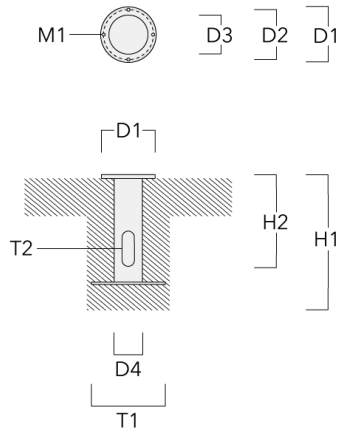

**117-0224**

**ZFY230 LED - 600 mm**

**we-ef**

## Optical Accessories

### Light shield

Description	Part ID	H1	Weight (kg)
LS180 ZFY	117-0228	49	0.03

