



Description

IP66, Class I. Class II on request. IK07. Marine-grade, die-cast aluminium alloy. 5CE superior corrosion protection including PCS hardware. Silicone CCG® Controlled Compression Gasket. Safety glass lens. One cable gland. Second gland for through wiring on request. Integral EC electronic converter, thermally separated. CAD-optimised optics for superior illumination and glare control. OLC® One LED Concept. Factory installed LED circuit board. 1-10V, DALI Interface or Eco Step Dim® on request. Maximum one internal optical accessory possible.

Optional 2200 K version up to max. 1050mA available, except version [EES]. To be specified at time of ordering.

Weight	12.60 kg
Light distribution	symmetric, wide beam [B]
Light source	LED-24/72W / 1050 mA - 3000 K
CRI	80
Power supply	EC
LEDs	24
Rated input power	81 W
Nominal Lumen (lm)	
LED Lumen	430
Total Lumen	10320
Tj	85
Rated lumens (lm)	
LED Lumen	369.5
Total Lumen	8869
Ta	25

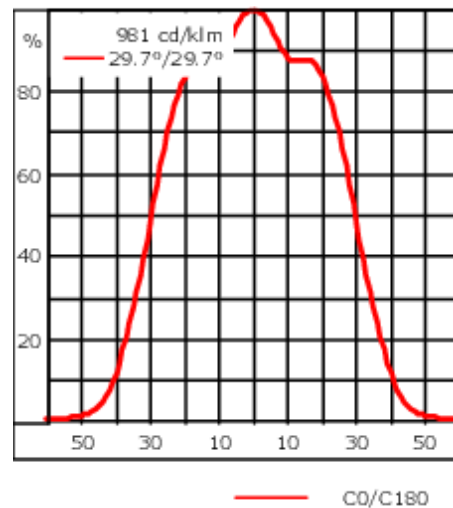
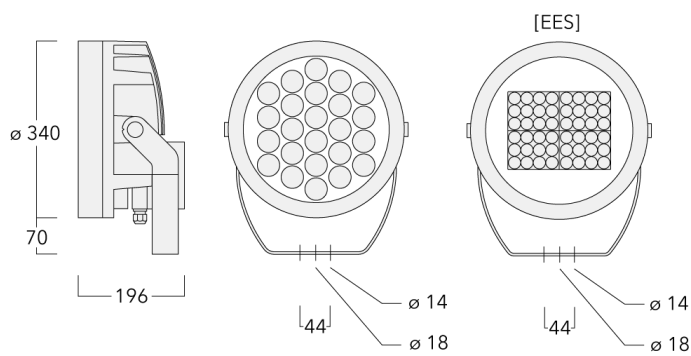

Specifications

Material description

Body	Marine-grade, die-cast aluminium alloy
Lens	Safety glass lens
Colours	<div style="display: flex; flex-direction: column; gap: 5px;"> <div> RAL9004 Signal black</div> <div> RAL9006 White aluminium</div> <div> RAL9007 Grey aluminium</div> <div> RAL7016 Anthracite grey</div> <div> RAL9016 Traffic white</div> </div>
Gasket	Silicone rubber gasket
Fasteners	PCS Polymer Coated Stainless Steel Hardware
Ingress protection	IP66
Impact resistance	IK07
Corrosion resistance	5CE
Windage	0.090 m ²

Electrical description

Power supply	220-240V / 50-60 Hz
Driver / Ballast	Standard. Optional DALI version available. To be specified at time of ordering.
Power factor	> 0.9
Surge protection	6/6 kV (optional SP10)

Additional information

Lifetime	Ta=25° L90B10 > 90000h
----------	------------------------

WE-EF LEUCHTEN GmbH

Töpinger Straße 16, 29646 Bispingen, Germany - Phone: +49 5194 909-0

info@we-ef.com - <https://we-ef.com>

Subject to technical changes and errors. - Generated on 23/10/2024

Mounting Accessories

Short post EM

Description	Part ID	D1	D2	H1	M1	Weight (kg)
EM1-M16 AL	270-9038	160	130	203	9	2

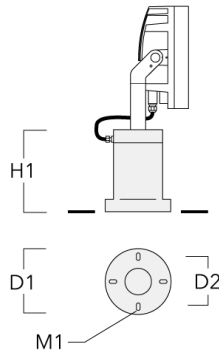

Floodlight mounting bracket TA

Description	Part ID	A	C1	D x L1	Weight (kg)	D x S
TA1 Mounting bracket, single* (Ø 76 x 200)	147-0023		130	76 x 200	1.90	76 x 200



FLC240 LED

Description	Part ID	A	C1	D × L1	Weight (kg)	D × S
TA2 Mounting bracket, double* (Ø 76 x 200)	147-0024		130	76 x 200	1.90	76 x 200



TA2-L Mounting bracket, double (Ø 76 x 200)	147-0105	±90°	420	76 x 200	16.10	76 x 200
---	----------	------	-----	----------	-------	----------

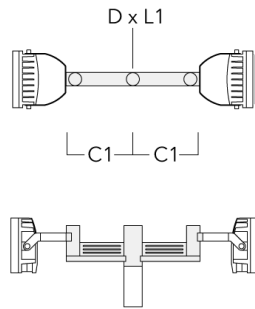

Description	Part ID	A	C1	D x L1	Weight (kg)	D x S
TA3 Mounting bracket, triple (Ø 89 x 200)	147-0025	±90°	650	89 x 200	17.90	89 x 200



TA4 Mounting bracket, quad (Ø 89 x 200)	147-0099	±90°	650	89 x 200	20.80	89 x 200
---	----------	------	-----	----------	-------	----------



FLC240 LED

Description	Part ID	A	C1	D × L1	Weight (kg)	D × S
TA1 Mounting bracket, single (Ø 108 x 200)	147-0096		130	108 x 200	7.50	108 x 200



TA2 Mounting bracket, double (Ø 108 x 200)	147-0097		130	108 x 200	7.50	108 x 200
--	----------	--	-----	-----------	------	-----------



Description	Part ID	A	C1	D x L1	Weight (kg)	D x S
TA2-L Mounting bracket, double (Ø 108 x 200)	147-0148	±90°	420	108 x 200	20.20	108 x 200

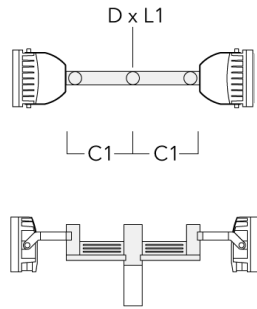

TA3 Mounting bracket, triple (Ø 108 x 200)	147-0098	±90°	650	108 x 200	24.20	108 x 200
--	----------	------	-----	-----------	-------	-----------

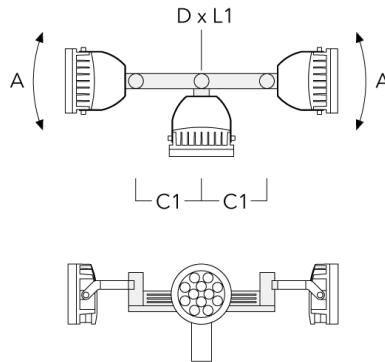

FLC240 LED

Description	Part ID	A	C1	D × L1	Weight (kg)	D × S
TA4 Mounting bracket, quad (Ø 108 x 200)	147-0100	±90°	650	108 x 200	24.20	108 x 200



Pole clamp TS

Description	Part ID	D1	Weight (kg)	D
TS1-2/M12 Pole clamp, single (Ø 76-89)	147-0543	76-89	1.40	76-89

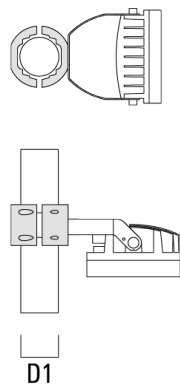

Description	Part ID	D1	Weight (kg)	D
TS1-2/M12 Pole clamp, single (Ø 102-114)	147-0526	102-114	1.50	102-114

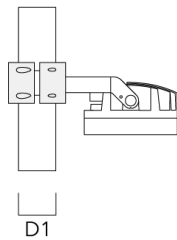
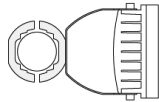

TS1-2/M12 Pole clamp, single (Ø 114-133)	147-0544	114-133	1.70	114-133
--	----------	---------	------	---------

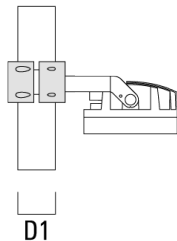
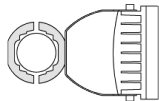

FLC240 LED

Description	Part ID	D1	Weight (kg)	D
TS2-2/M12 Pole clamp, double (Ø 76-89)	147-0545	76-89	1.40	76-89



TS2-2/M12 Pole clamp, double (Ø 102-114)	147-0527	102-114	1.50	102-114
--	----------	---------	------	---------



Description	Part ID	D1	Weight (kg)	D
TS2-2/M12 Pole clamp, double (Ø 114-133)	147-0546	114-133	1.60	114-133



Planted root

Description	Part ID	D1	D2	D3	D4	H1	H2	M1	Weight (kg)
Planted root ESV4	300-0461	145	130	102	108	400	350	8	7.05

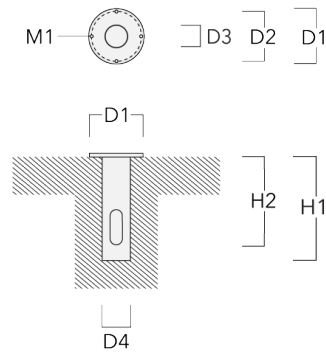

Pole clamp PC

WE-EF LEUCHTEN GmbH

Töpinger Straße 16, 29646 Bispingen, Germany - Phone: +49 5194 909-0

info@we-ef.com - <https://we-ef.com>

Subject to technical changes and errors. - Generated on 23/10/2024

139-1923

FLC240 LED

we-ef

Description	Part ID	D1	Weight (kg)
PC2 76-89/60 Pole clamp, double (Ø 76-89)	139-2703	76-89	1.00



PC1 76-89/60 Pole clamp, single (Ø 76-89)	139-2702	76-89	1.00
---	----------	-------	------



WE-EF LEUCHTEN GmbH

Töpinger Straße 16, 29646 Bispingen, Germany - Phone: +49 5194 909-0
info@we-ef.com - <https://we-ef.com>

Subject to technical changes and errors. - Generated on 23/10/2024

Description	Part ID	D1	Weight (kg)
PC2 102-114/60 Pole clamp, double (Ø 102-114)	139-2707	102-114	1.20



PC1 102-114/60 Pole clamp, single (Ø 102-114)	139-2706	102-114	1.20
--	----------	---------	------



Description	Part ID	D1	Weight (kg)
PC2 114-133/60 Pole clamp, double (Ø 114-133)	139-2709	114-133	1.40



PC1 114-133/60 Pole clamp, single (Ø 114-133)	139-2708	114-133	1.40
--	----------	---------	------



139-1923

FLC240 LED

we-ef

Description	Part ID	D1	Weight (kg)
PC2 82-109/60 Pole camp, double (Ø 82-109)	139-2705	82-109	1.10



WE-EF LEUCHTEN GmbH

Töpinger Straße 16, 29646 Bispingen, Germany - Phone: +49 5194 909-0

info@we-ef.com - <https://we-ef.com>

Subject to technical changes and errors. - Generated on 23/10/2024

139-1923

FLC240 LED

we-ef

Control

Eco Step Dim® Basic

Description	Part ID
Eco Step Dim® Basic LED	430-0001

Eco Step Dim® Advanced

Description	Part ID
Eco Step Dim® Advanced LED	430-0002

R2C Ready to Connect

Description	Part ID
R2C Ready to Connect (top)	430-0019

WE-EF LEUCHTEN GmbH

Töpinger Straße 16, 29646 Bispingen, Germany - Phone: +49 5194 909-0

info@we-ef.com - <https://we-ef.com>

Subject to technical changes and errors. - Generated on 23/10/2024

139-1923

FLC240 LED

we-ef

Optical Accessories

Flood lens

Description	Part ID	C1
IO-360-FLC240-LED	139-1856	289



Honeycomb louvre

Description	Part ID	C1
Honeycomb Louvre IW	139-1857	279

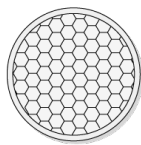

Snoot

WE-EF LEUCHTEN GmbH

Töpinger Straße 16, 29646 Bispingen, Germany - Phone: +49 5194 909-0

info@we-ef.com - <https://we-ef.com>

Subject to technical changes and errors. - Generated on 23/10/2024

FLC240 LED

Description	Part ID	A	C1
ET-FLC240-LED	139-1859	200	346

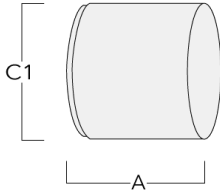

Glare shield

Description	Part ID	A	C1
ES-FLC240-LED	139-1858	200	346

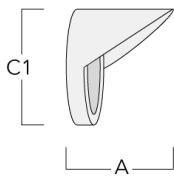

Wallwash lens

WE-EF LEUCHTEN GmbH

Töpinger Straße 16, 29646 Bispingen, Germany - Phone: +49 5194 909-0

info@we-ef.com - <https://we-ef.com>

Subject to technical changes and errors. - Generated on 23/10/2024

Description	Part ID	Additional information	C1
IO-20-FLC240-LED	139-1854	for symmetric [M] medium beam luminaire only	289

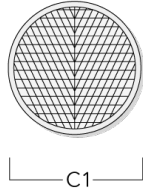

Linear spread lens

Description	Part ID	C1
Linear spread lens IO-180	139-1855	289

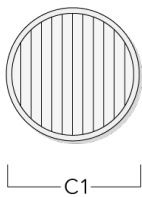

139-1923

FLC240 LED

WE-EF LEUCHTEN GmbH

Töpinger Straße 16, 29646 Bispingen, Germany

Phone: +49 5194 909-0

info@we-ef.com

<https://we-ef.com>

Subject to technical changes and errors.

Generated on 23/10/2024