



Description

IP66. Classe I. Classe II sur demande. IK07. Corps en fonte d'aluminium. Visserie inox avec traitement PCS. Protection contre la corrosion 5CE. Joint silicone. Verre de sécurité. Luminaire contrôlé via le protocole DALI en standard. Version en 2200K disponible jusqu'à 1050mA, sauf pour la photométrie [EES]. À préciser lors de la demande de devis.

Poids	12.60 kg
Distribution de la lumière	faisceau symétrique, extensif [B]
Source lumineuse	LED-24/72W / 1050 mA - 4000 K
IRC	80
Alimentation électrique	ballast électronique
LEDs	24
Rated input power	81 W
Flux lumineux nominal (lm)	
LED Lumen	450
Total Lumen	10800
Tj	85
Rated lumens (lm)	
LED Lumen	386.7
Total Lumen	9281.5
Ta	25

WE-EF Switzerland AG

Himmelrichstrasse 6, 6003 Luzern - Téléphone: +41 22 752 49 94
info.switzerland@we-ef.com - https://we-ef.com/ch_fr

Sous réserve de modifications techniques et d'erreurs. - Généré le 23/11/2024

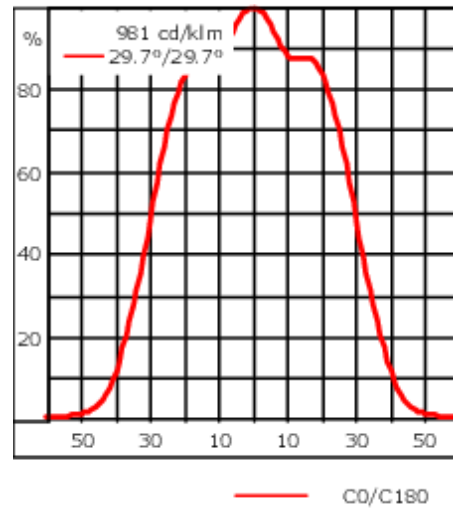
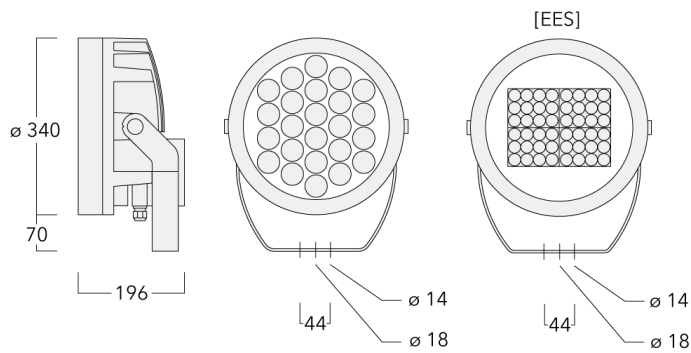
139-1924**FLC240 LED****we-ef**

Spécifications

Description du matériel

Corps	Corps en fonte d'aluminium
Lentille	Verre de sécurité
Couleurs	<div style="display: flex; align-items: center;"> <div style="width: 20px; height: 15px; background-color: black; margin-right: 5px;"></div> RAL9004 Noir de sécurité </div> <div style="display: flex; align-items: center; margin-top: 5px;"> <div style="width: 20px; height: 15px; background-color: gray; margin-right: 5px;"></div> RAL9007 Aluminium gris </div> <div style="display: flex; align-items: center; margin-top: 5px;"> <div style="width: 20px; height: 15px; background-color: darkgray; margin-right: 5px;"></div> RAL7016 Gris anthracite </div> <div style="display: flex; align-items: center; margin-top: 5px;"> <div style="width: 20px; height: 15px; background-color: lightgray; margin-right: 5px;"></div> RAL9016 Blanc signalisation </div>
Joint	Joint silicone
Visserie	Visserie inox avec traitement PCS
IP	IP66
IK	IK07
Protection contre la corrosion	5CE
Surface exposée au vent	0.090 m ²

Description électrique

Driver	Standard - version DALI disponible en option
Power factor	> 0.9

Informations complémentaires

Durée de vie	Ta=25° L90B10 > 90000h
--------------	------------------------

WE-EF Switzerland AG

Himmelrichstrasse 6, 6003 Luzern - Téléphone: +41 22 752 49 94

info.switzerland@we-ef.com - https://we-ef.com/ch_fr

Sous réserve de modifications techniques et d'erreurs. - Généré le 23/11/2024

Accessoires d'installation

Socle de montage EM

Description	Référence	D1	D2	H1	M1	Poids (kg)
EM1-M16 socle de montage	270-9038	160	130	203	9	2

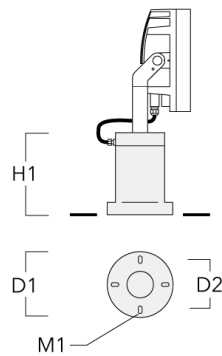

Traverse pour mâts

Description	Référence	A	C1	D x L1	Poids (kg)	D x S
TA1 traverse simple (Ø 76 x 200)	147-0023		130	76 x 200	1.90	76 x 200

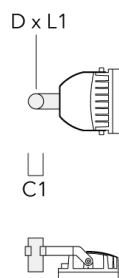

Description	Référence	A	C1	D x L1	Poids (kg)	D x S
TA2 traverse double (Ø 76 x 200)	147-0024		130	76 x 200	1.90	76 x 200

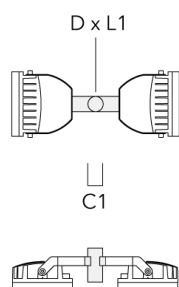

TA2-L traverse longue orientable (Ø 76 x 200)	147-0105	±90°	420	76 x 200	16.10	76 x 200
-----------------------------------------------	----------	------	-----	----------	-------	----------

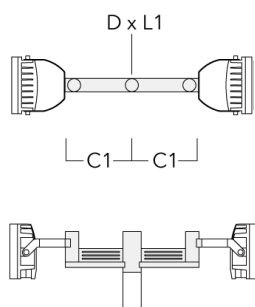

Description	Référence	A	C1	D x L1	Poids (kg)	D x S
TA3 traverse triple orientable (Ø 89 x 200)	147-0025	±90°	650	89 x 200	17.90	89 x 200

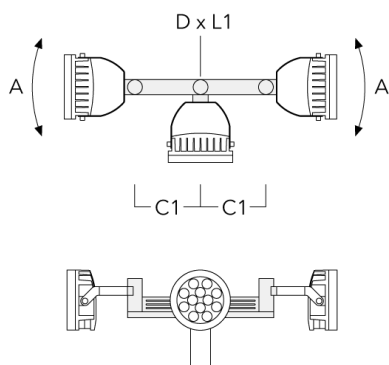

TA4 Traverse pour 4 projecteurs (Ø 89 x 200)	147-0099	±90°	650	89 x 200	20.80	89 x 200
----------------------------------------------	----------	------	-----	----------	-------	----------

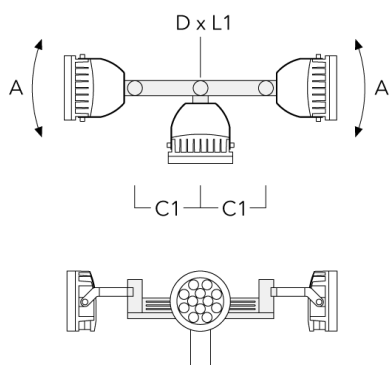

Description	Référence	A	C1	D x L1	Poids (kg)	D x S
TA1 traverse simple (Ø 108 x 200)	147-0096		130	108 x 200	7.50	108 x 200

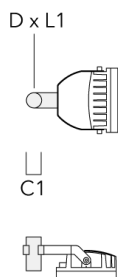

TA2 traverse double (Ø 108 x 200)	147-0097		130	108 x 200	7.50	108 x 200
-----------------------------------	----------	--	-----	-----------	------	-----------

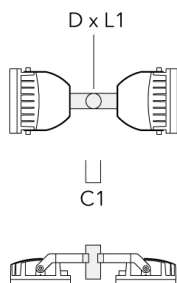

FLC240 LED

Description	Référence	A	C1	D x L1	Poids (kg)	D x S
TA2-L traverse longue orientable (Ø 108 x 200)	147-0148	±90°	420	108 x 200	20.20	108 x 200

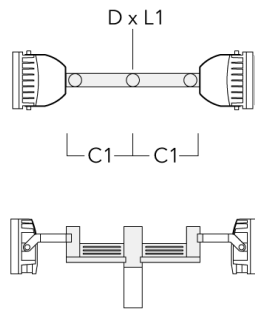

TA3 traverse triple orientable (Ø 108 x 200)	147-0098	±90°	650	108 x 200	24.20	108 x 200
----------------------------------------------	----------	------	-----	-----------	-------	-----------

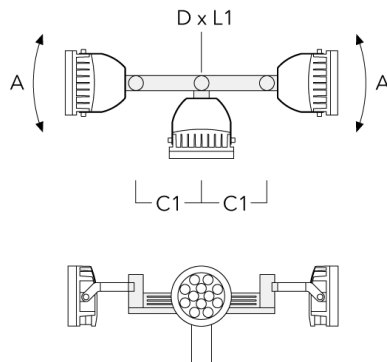

WE-EF Switzerland AG

Himmelrichstrasse 6, 6003 Luzern - Téléphone: +41 22 752 49 94

info.switzerland@we-ef.com - https://we-ef.com/ch_fr

Sous réserve de modifications techniques et d'erreurs. - Généré le 23/11/2024

FLC240 LED

Description	Référence	A	C1	D x L1	Poids (kg)	D x S
TA4 Traverse pour 4 projecteurs (Ø 108 x 200)	147-0100	±90°	650	108 x 200	24.20	108 x 200

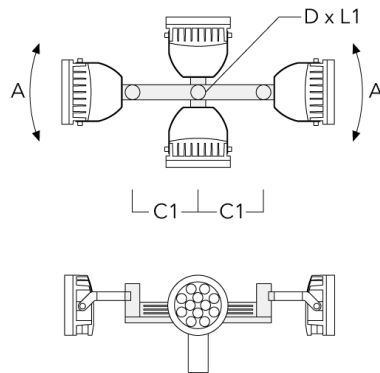

Collier pour mâts TS

Description	Référence	D1	Poids (kg)	D
TS1-2/M12 collier simple pour tube (Ø 76-89)	147-0543	76-89	1.40	76-89

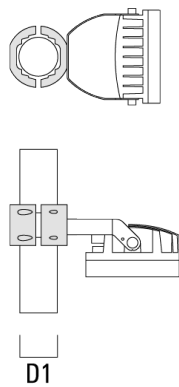

Description	Référence	D1	Poids (kg)	D
TS1-2/M12 collier simple pour tube (Ø 102-114)	147-0526	102-114	1.50	102-114

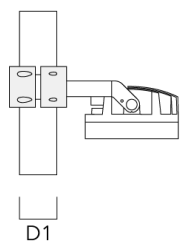
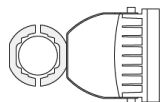

TS1-2/M12 collier simple pour tube (Ø 114-133)	147-0544	114-133	1.70	114-133
---------------------------------------------------	----------	---------	------	---------

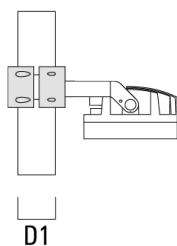
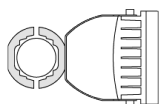

Description	Référence	D1	Poids (kg)	D
TS2-2/M12 collier double pour tube (Ø 76-89)	147-0545	76-89	1.40	76-89

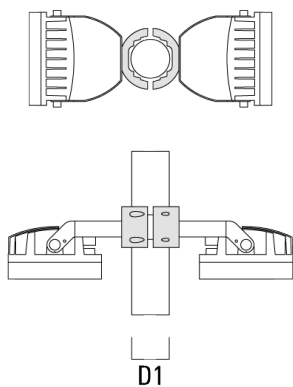

TS2-2/M12 collier double pour tube (Ø 102-114)	147-0527	102-114	1.50	102-114
---------------------------------------------------	----------	---------	------	---------

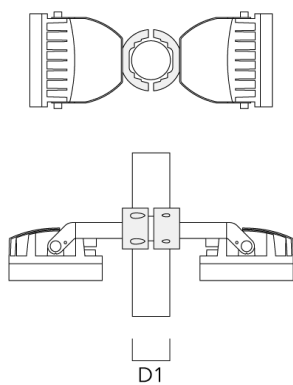

Description	Référence	D1	Poids (kg)	D
TS2-2/M12 colier double pour tube (Ø 114-133)	147-0546	114-133	1.60	114-133

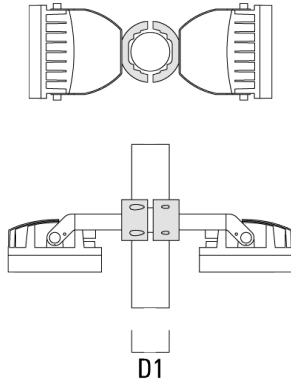

Base à enterrer

Description	Référence	D1	D2	D3	D4	H1	H2	M1	Poids (kg)
Base à enterrer ESV4	300-0461	145	130	102	108	400	350	8	7.05

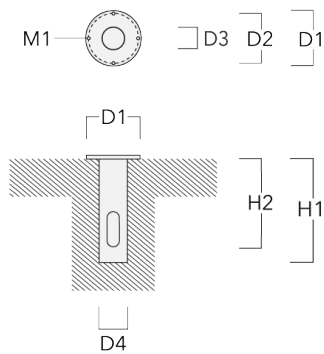

Collier pour mâts PC

Description	Référence	D1	Poids (kg)
PC2 76-89/60 collier double pour tube (Ø 76-89)	139-2703	76-89	1.00

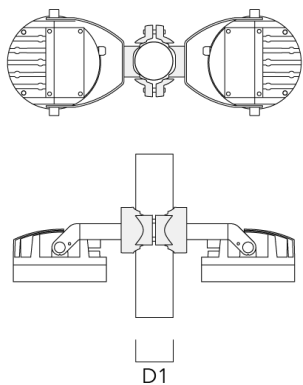

PC1 76-89/60 collier simple (Ø 76-89)	139-2702	76-89	1.00
---------------------------------------	----------	-------	------

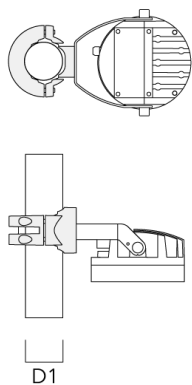

Description	Référence	D1	Poids (kg)
PC2 102-114/60 collier double pour tube (Ø 102-114)	139-2707	102-114	1.20

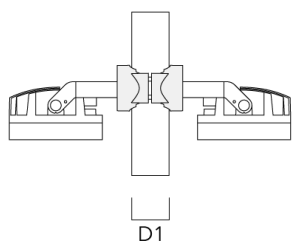
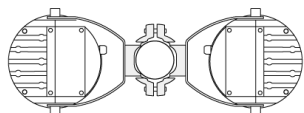

PC1 102-114/60 collier simple (Ø 102-114)	139-2706	102-114	1.20
-------------------------------------------	----------	---------	------

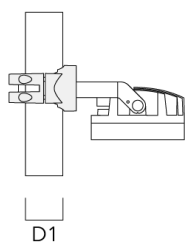
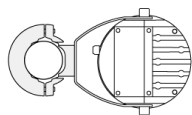

Description	Référence	D1	Poids (kg)
PC2 114-133/60 collier double pour tube (Ø 114-133)	139-2709	114-133	1.40

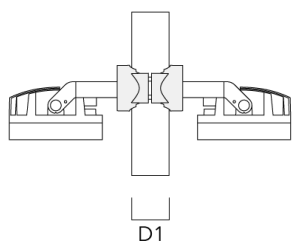
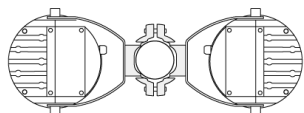

PC1 114-133/60 collier simple (Ø 114-133)	139-2708	114-133	1.40
-------------------------------------------	----------	---------	------

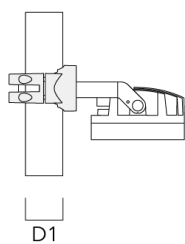
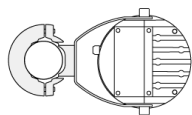

Description	Référence	D1	Poids (kg)
PC2 82-109/60 collier double pour tube (Ø 82-109)	139-2705	82-109	1.10

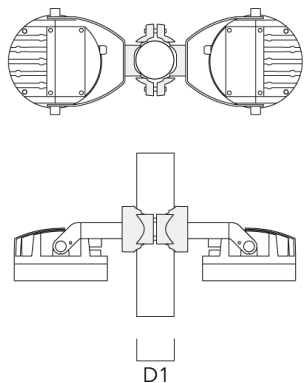

Control**Eco Step Dim® Basic**

Description	Référence
Eco Step Dim® Basic LED	430-0001

Eco Step Dim® Advanced

Description	Référence
Eco Step Dim® Advanced LED	430-0002

R2C Ready to Connect

Description	Référence
R2C Ready to Connect (top)	430-0019

Accessoires Optiques

Lentille e'largissante

Description	Référence	C1
IO-360-FLC240-LED	139-1856	289

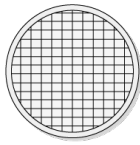

C1

Grille nid d'abeille

Description	Référence	C1
Honeycomb Louvre IW	139-1857	279

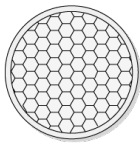

C1

Canon anti-éblouissement

Description	Référence	A	C1
ET-FLC240-LED	139-1859	200	346

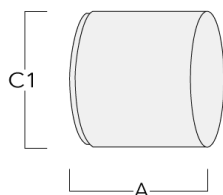
**Visière**

Description	Référence	A	C1
ES-FLC240-LED	139-1858	200	346

