



Description

IP66. Class I. IK07. Marine-grade, die-cast aluminium alloy. 5CE superior corrosion protection including PCS hardware. Safety glass lens. Silicone CCG® Controlled Compression Gasket.

Integral EC electronic converter in thermally-separated compartment. Advanced thermal management protects LEDs while optimising lumens output. CAD-optimised optics for superior illumination and glare control. OLC® One LED Concept.

For 2200 K version available on request, except [EES] distribution.

Weight	12.60 kg
Light distribution	symmetric, wide beam [B]
Light source	LED-24/104W / 1400 mA - 3000 K
CRI	80
Power supply	EC
LEDs	24
Rated input power	112 W
Nominal Lumen (lm)	
LED Lumen	550
Total Lumen	13200
T _j	85
Rated lumens (lm)	
LED Lumen	456.7
Total Lumen	10960.8
T _a	25

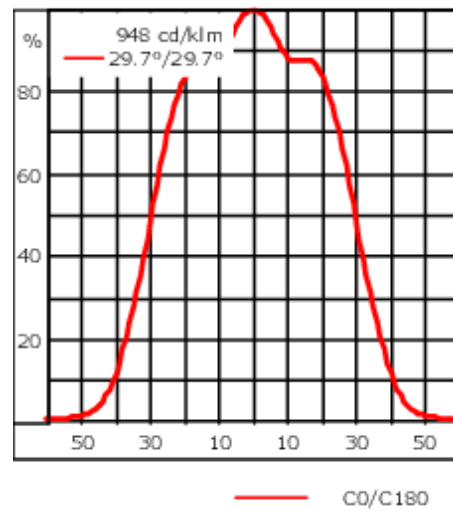
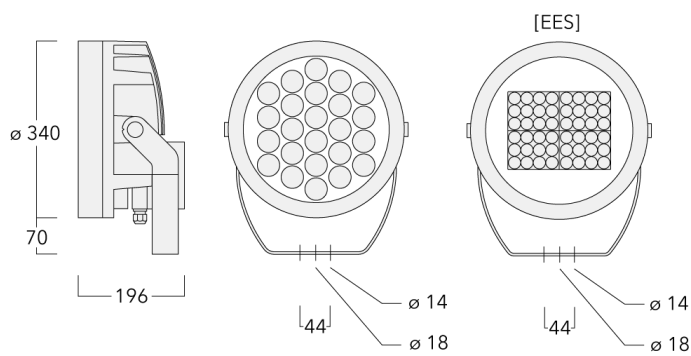

Specifications

Material description

Body	Marine-grade, die-cast aluminium alloy
Lens	Safety glass lens
Colours	<div style="display: flex; align-items: center;"> <div style="width: 20px; height: 15px; background-color: black; margin-right: 5px;"></div> RAL9004 Signal black </div> <div style="display: flex; align-items: center; margin-top: 5px;"> <div style="width: 20px; height: 15px; background-color: #808080; margin-right: 5px;"></div> RAL9007 Grey aluminium </div> <div style="display: flex; align-items: center; margin-top: 5px;"> <div style="width: 20px; height: 15px; background-color: #404040; margin-right: 5px;"></div> RAL7016 Anthracite grey </div> <div style="display: flex; align-items: center; margin-top: 5px;"> <div style="width: 20px; height: 15px; background-color: #e0e0e0; margin-right: 5px;"></div> RAL9016 Traffic white </div>
Gasket	Silicone CCG® Controlled Compression Gasket
Fasteners	PCS Polymer Coated Stainless Steel Hardware
Ingress protection	IP66
Impact resistance	IK07
Corrosion resistance	5CE
Windage	0.090 m ²

Electrical description

Driver / Ballast	Integral EC electronic converter in thermally-separated compartment
Power factor	> 0.9

Additional information

Lifetime	Ta=25° L90B10 > 90000h
----------	------------------------

Mounting Accessories

Short post

Description	Part ID	D1	D2	H1	M1	Weight (kg)
Short post EM1-M16	270-9038	160	130	203	9	2.10



Planted root

Description	Part ID	D1	D2	D3	D4	H1	H2	M1	T1	T2	Weight (kg)
Planted root ESV4	300-0461-AP	150	130	60	89	400	350	8	200	50 x 100	3.85

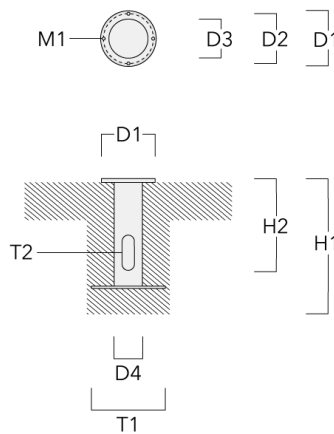

Floodlight mounting bracket TA

Description	Part ID	A	C1	D x L1	Weight (kg)	D x S
TA2-L Mounting bracket, double (Ø 76 x 200)	147-0105	±90°	420	76 x 200	16.10	76 x 200



TA3 Mounting bracket, triple (Ø 89 x 200)	147-0025	±90°	650	89 x 200	17.90	89 x 200
---	----------	------	-----	----------	-------	----------



FLC240 LED

Description	Part ID	A	C1	D × L1	Weight (kg)	D × S
TA4 Mounting bracket, quad (Ø 89 x 200)	147-0099	±90°	650	89 x 200	20.80	89 x 200



TA1 Mounting bracket, single (Ø 108 x 200)	147-0096		130	108 x 200	7.50	108 x 200
--	----------	--	-----	-----------	------	-----------



Description	Part ID	A	C1	D × L1	Weight (kg)	D × S
TA2 Mounting bracket, double (Ø 108 x 200)	147-0097		130	108 x 200	7.50	108 x 200



TA2-L Mounting bracket, double (Ø 108 x 200)	147-0148	±90°	420	108 x 200	20.20	108 x 200
--	----------	------	-----	-----------	-------	-----------

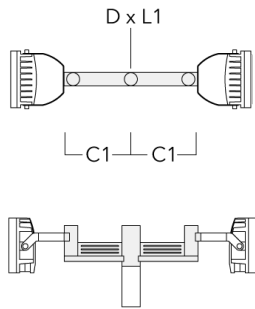

Description	Part ID	A	C1	D x L1	Weight (kg)	D x S
TA3 Mounting bracket, triple (Ø 108 x 200)	147-0098	±90°	650	108 x 200	24.20	108 x 200



TA4 Mounting bracket, quad (Ø 108 x 200)	147-0100	±90°	650	108 x 200	24.20	108 x 200
--	----------	------	-----	-----------	-------	-----------

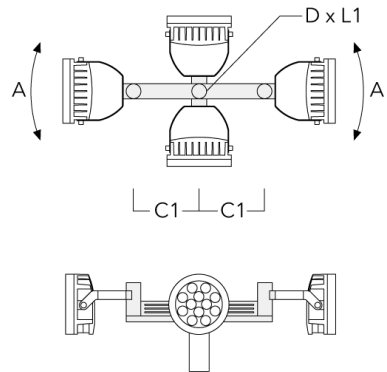

139-1925

FLC240 LED

we-ef

Spigot cap

Description	Part ID	D1	Weight (kg)
Spigot Cap KF1-M16 (ø 60 x 100)	310-9120	60 x 100	1.40



Spigot Cap KF1-M16 (ø 76 x 100)	310-9121	76 x 100	2.2
---------------------------------	----------	----------	-----



Pole clamp SP - Tiltable

Description	Part ID	D1	Weight (kg)	D
Pole clamp SP1-M16, single (Ø 76-89)	146-0242	76-89	1.30	76-89

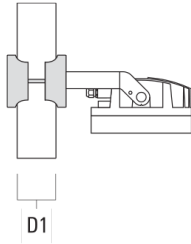

Pole clamp SP2-M16, double (Ø 76-89)	146-0244	76-89	1.50	
--------------------------------------	----------	-------	------	--

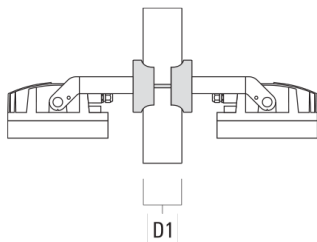

FLC240 LED

Description	Part ID	D1	Weight (kg)	D
Pole clamp SP1-M16, single (Ø 38-60)	146-0241	38-60	1.30	

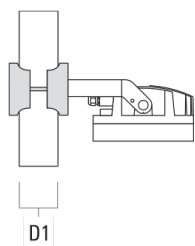

Pole clamp SP2-M16, double (Ø 38-60)	146-0243	38-60	1.50	
--------------------------------------	----------	-------	------	--

Junction box

Description	Part ID	Additional information	A	B	C1	Weight (kg)
Junction box JB20 - Cable side entries	310-9013	Junction boxes are made from marine-grade, die-cast aluminium alloy. IK10. IP66. For side entries and suitable to be used with cable glands.	180	143	51	1.02

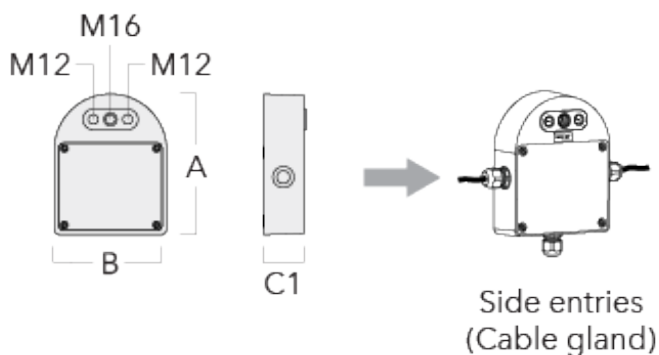

Description	Part ID	Additional information	A	B	C1	Weight (kg)
Junction box JB20 - Conduit side entries	310-9014	Junction boxes are made from marine-grade, die-cast aluminium alloy. IK10. IP66. For side entries and suitable to be used with conduits.	180	143	51	1.02

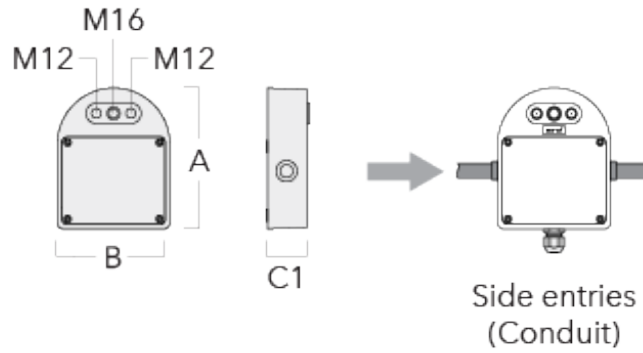

Junction box JB20 - Wall entries	310-9018	Junction boxes are made from marine-grade, die-cast aluminium alloy. IK10. IP66. For wall entries.	180	143	51	1.02
----------------------------------	----------	--	-----	-----	----	------

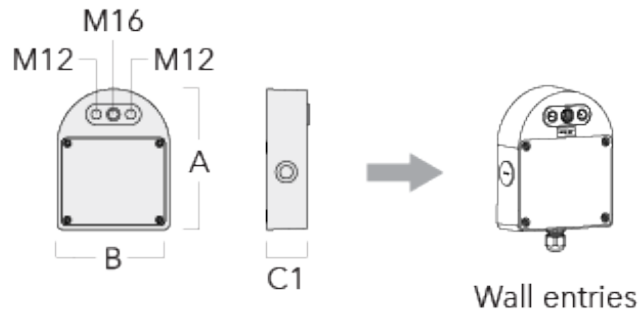

Pole clamp PC - Rotatable

Description	Part ID	D1	Weight (kg)
PC2 76-89/60 Pole clamp, double (Ø 76-89)	139-2703	76-89	1.00



PC1 76-89/60 Pole clamp, single (Ø 76-89)	139-2702	76-89	1.00
---	----------	-------	------



Description	Part ID	D1	Weight (kg)
PC2 102-114/60 Pole clamp, double (Ø 102-114)	139-2707	102-114	1.20



PC1 102-114/60 Pole clamp, single (Ø 102-114)	139-2706	102-114	1.20
--	----------	---------	------



Description	Part ID	D1	Weight (kg)
PC2 114-133/60 Pole clamp, double (Ø 114-133)	139-2709	114-133	1.40



PC1 114-133/60 Pole clamp, single (Ø 114-133)	139-2708	114-133	1.40
--	----------	---------	------



139-1925

FLC240 LED

we-ef

Description	Part ID	D1	Weight (kg)
PC2 82-109/60 Pole camp, double (Ø 82-109)	139-2705	82-109	1.10



WE-EF LIGHTING (Thailand) Co., Ltd.

57 Moo 5, Kingkaew Rd., Bangplee, 10540 Samutprakarn - Phone: +66 2 738 96 20 - Fax: +66 2 738 96 29

<https://we-ef.com/asia>

Subject to technical changes and errors. - Generated on 23/11/2024

139-1925

FLC240 LED

we-ef

Control

1-10 V analogue dimming interface

Description	Part ID	C
1-10 V analogue dimming interface	430-0011	90

R2C Ready to Connect

Description	Part ID
R2C Ready to Connect (top)	430-0019

WE-EF LIGHTING (Thailand) Co., Ltd.

57 Moo 5, Kingkaew Rd., Bangplee, 10540 Samutprakarn - Phone: +66 2 738 96 20 - Fax: +66 2 738 96 29

<https://we-ef.com/asia>

Subject to technical changes and errors. - Generated on 23/11/2024

Optical Accessories

Flood lens

Description	Part ID	C1
Flood lens IO-360	139-1856	289



Honeycomb louvre

Description	Part ID	C1
Honeycomb Louvre IW	139-1857	279

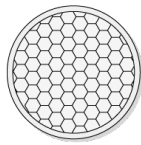

Snoot

Description	Part ID	A	C1
Snoot ET	139-1859	200	346



Glare shield

Description	Part ID	A	C1
Glare shield ES	139-1858	200	346



139-1925

FLC240 LED

we-ef

Wallwash lens

Description	Part ID	Additional information	C1
Wallwash lens IO-20	139-1854-AP	for symmetric [M] medium beam luminaire only	289



Linear spread lens

Description	Part ID	C1
Linear spread lens IO-180	139-1855	289



WE-EF LIGHTING (Thailand) Co., Ltd.

57 Moo 5, Kingkaew Rd., Bangplee, 10540 Samutprakarn - Phone: +66 2 738 96 20 - Fax: +66 2 738 96 29

<https://we-ef.com/asia>

Subject to technical changes and errors. - Generated on 23/11/2024