



### Description

IP66, Class I. Class II on request.

IK07. Marine-grade, die-cast aluminium alloy. 5CE superior corrosion protection including PCS hardware. Silicone CCG® Controlled Compression Gasket. Safety glass lens. One cable gland. Second gland for through wiring on request. Integral EC electronic converter, thermally separated. CAD-optimised optics for superior illumination and glare control. OLC® One LED Concept. Factory installed LED circuit board. 1-10V, DALI Interface or Eco Step Dim® on request. Maximum one internal optical accessory possible.

Optional 2200 K version up to max. 1050mA available, except version [EES]. To be specified at time of ordering.

|                    |                               |
|--------------------|-------------------------------|
| Weight             | 7.60 kg                       |
| Light distribution | symmetric, wide beam [B]      |
| Light source       | LED-12/52W / 1400 mA - 3000 K |
| CRI                | 80                            |
| Power supply       | EC                            |
| LEDs               | 12                            |
| Rated input power  | 55 W                          |

### Nominal Lumen (lm)

|             |      |
|-------------|------|
| LED Lumen   | 550  |
| Total Lumen | 6600 |
| Tj          | 85   |

### Rated lumens (lm)

|             |        |
|-------------|--------|
| LED Lumen   | 456.7  |
| Total Lumen | 5480.4 |
| Ta          | 25     |

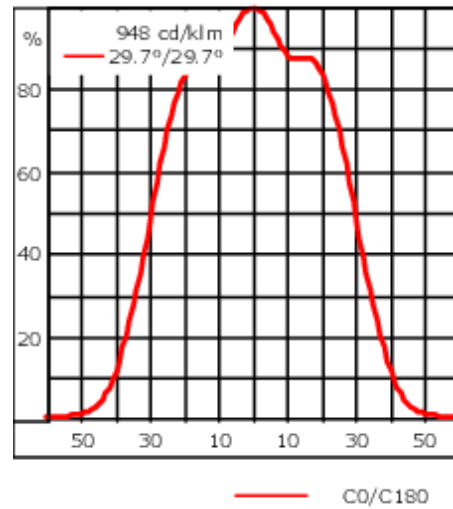
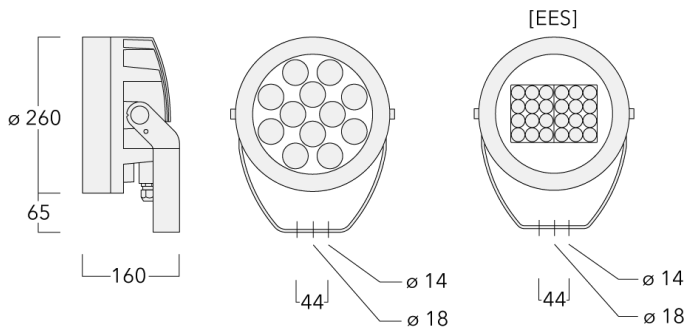

## Specifications

### Material description

|                      |  |
|----------------------|--|
| Body                 | Marine-grade, die-cast aluminium alloy   |
| Lens                 | Safety glass lens  |
| Colours              | <div style="display: flex; flex-direction: column; gap: 5px;"> <div><span style="display: inline-block; width: 20px; height: 10px; background-color: black; margin-right: 5px;"></span> RAL9004 Signal black</div> <div><span style="display: inline-block; width: 20px; height: 10px; background-color: #cccccc; margin-right: 5px;"></span> RAL9006 White aluminium</div> <div><span style="display: inline-block; width: 20px; height: 10px; background-color: #808080; margin-right: 5px;"></span> RAL9007 Grey aluminium</div> <div><span style="display: inline-block; width: 20px; height: 10px; background-color: #333333; margin-right: 5px;"></span> RAL7016 Anthracite grey</div> <div><span style="display: inline-block; width: 20px; height: 10px; background-color: #e0e0e0; margin-right: 5px;"></span> RAL9016 Traffic white</div> </div> |
| Gasket               | Silicone CCG® Controlled Compression Gasket  |
| Fasteners            | PCS Polymer Coated Stainless Steel Hardware  |
| Ingress protection   | IP66   |
| Impact resistance    | IK07   |
| Corrosion resistance | 5CE  |
| Windage              | 0.054 m <sup>2</sup>   |

### Electrical description

|                  |   |
|------------------|---|
| Power supply     | 220-240V / 50-60 Hz   |
| Driver / Ballast | Standard. Optional DALI version available. To be specified at time of ordering. |
| Power factor     | > 0.9   |
| Surge protection | 6/6 kV (SP10 optional)  |

**139-1911**

**FLC230 LED**

**we-ef**

**Additional information**

---

Lifetime Ta=25° L90B10 > 90000h

Energy efficiency class C-D (Light source)

---

**Fagerhult Lighting Ltd**

33-34 Dolben Street, SE1 0UQ London, United Kingdom

<https://we-ef.com/uk>

Subject to technical changes and errors. - Generated on 23/11/2024

**Mounting Accessories**

**Short post EM**

| Description | Part ID  | D1  | D2  | H1  | M1 | Weight (kg) |
|-------------|----------|-----|-----|-----|----|-------------|
| EM1-M16 AL  | 270-9038 | 160 | 130 | 203 | 9  | 2           |

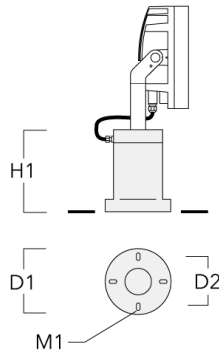

**Floodlight mounting bracket TA**

| Description                                | Part ID  | A | C1  | D x L1    | Weight (kg) | D x S     |
|--|----------|---|-----|-----------|-------------|-----------|
| TA1 Mounting bracket, single (Ø 108 x 200) | 147-0096 |   | 130 | 108 x 200 | 7.50        | 108 x 200 |

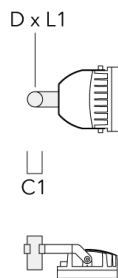

| Description                                | Part ID  | A | C1  | D × L1    | Weight (kg) | D × S     |
|--|----------|---|-----|-----------|-------------|-----------|
| TA2 Mounting bracket, double (Ø 108 x 200) | 147-0097 |   | 130 | 108 x 200 | 7.50        | 108 x 200 |

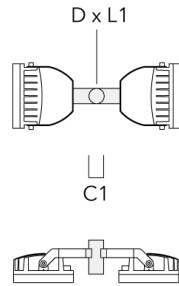

|  |          |      |     |           |       |           |
|--|----------|------|-----|-----------|-------|-----------|
| TA2-L Mounting bracket, double (Ø 108 x 200) | 147-0148 | ±90° | 420 | 108 x 200 | 20.20 | 108 x 200 |
|--|----------|------|-----|-----------|-------|-----------|

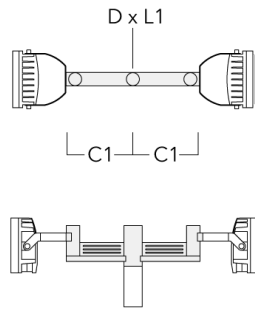

| Description                                 | Part ID  | A    | C1  | D x L1   | Weight (kg) | D x S    |
|---|----------|------|-----|----------|-------------|----------|
| TA2-L Mounting bracket, double (Ø 76 x 200) | 147-0105 | ±90° | 420 | 76 x 200 | 16.10       | 76 x 200 |

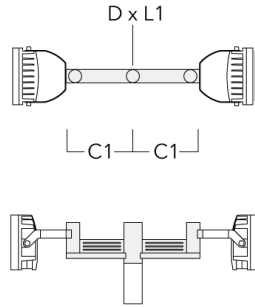

|   |          |      |     |          |       |          |
|---|----------|------|-----|----------|-------|----------|
| TA3 Mounting bracket, triple (Ø 89 x 200) | 147-0025 | ±90° | 650 | 89 x 200 | 17.90 | 89 x 200 |
|---|----------|------|-----|----------|-------|----------|

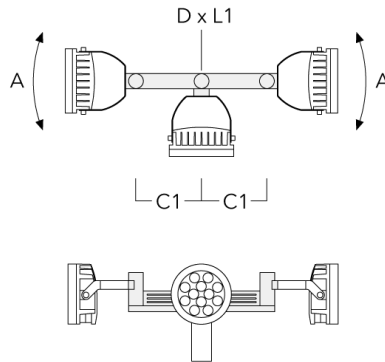

| Description                                | Part ID  | A    | C1  | D x L1    | Weight (kg) | D x S     |
|--|----------|------|-----|-----------|-------------|-----------|
| TA3 Mounting bracket, triple (Ø 108 x 200) | 147-0098 | ±90° | 650 | 108 x 200 | 24.20       | 108 x 200 |

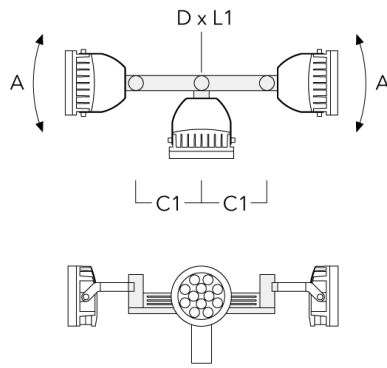

|   |          |      |     |          |       |          |
|---|----------|------|-----|----------|-------|----------|
| TA4 Mounting bracket, quad (Ø 89 x 200) | 147-0099 | ±90° | 650 | 89 x 200 | 20.80 | 89 x 200 |
|---|----------|------|-----|----------|-------|----------|

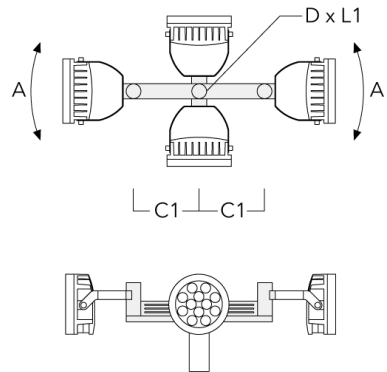

| Description                              | Part ID  | A    | C1  | D × L1    | Weight (kg) | D × S     |
|--|----------|------|-----|-----------|-------------|-----------|
| TA4 Mounting bracket, quad (Ø 108 x 200) | 147-0100 | ±90° | 650 | 108 x 200 | 24.20       | 108 x 200 |

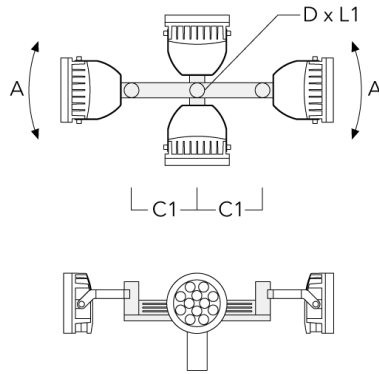

|  |          |  |     |          |      |          |
|--|----------|--|-----|----------|------|----------|
| TA2 Mounting bracket, double* (Ø 76 x 200) | 147-0024 |  | 130 | 76 x 200 | 1.90 | 76 x 200 |
|--|----------|--|-----|----------|------|----------|

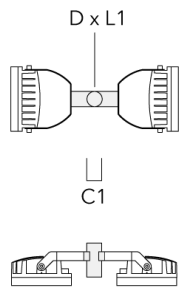



**FLC230 LED**

| Description                                | Part ID  | A | C1  | D × L1   | Weight (kg) | D × S    |
|--|----------|---|-----|----------|-------------|----------|
| TA1 Mounting bracket, single* (Ø 76 x 200) | 147-0023 |   | 130 | 76 x 200 | 1.50        | 76 x 200 |

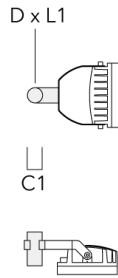

**Pole clamp TS**

| Description                              | Part ID  | D1      | Weight (kg) | D       |
|--|----------|---------|-------------|---------|
| TS1-2/M12 Pole clamp, single (Ø 102-114) | 147-0526 | 102-114 | 1.50        | 102-114 |

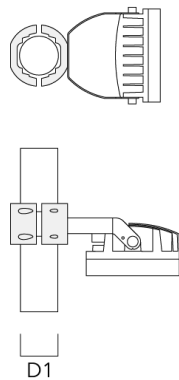

| Description                              | Part ID  | D1      | Weight (kg) | D       |
|--|----------|---------|-------------|---------|
| TS1-2/M12 Pole clamp, single (Ø 114-133) | 147-0544 | 114-133 | 1.70        | 114-133 |

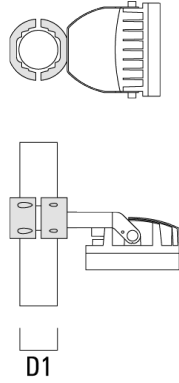

|  |          |       |      |       |
|--|----------|-------|------|-------|
| TS1-2/M12 Pole clamp, single (Ø 76-89) | 147-0543 | 76-89 | 1.40 | 76-89 |
|--|----------|-------|------|-------|

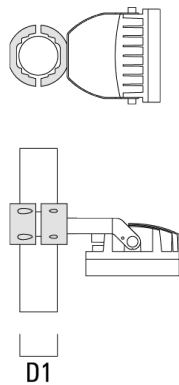

| Description                            | Part ID  | D1    | Weight (kg) | D     |
|--|----------|-------|-------------|-------|
| TS2-2/M12 Pole clamp, double (Ø 76-89) | 147-0545 | 76-89 | 1.40        | 76-89 |

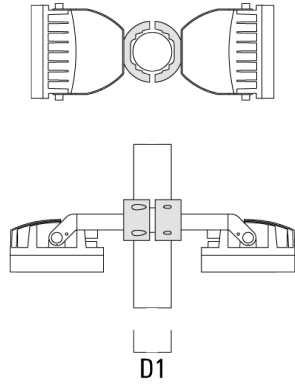

|  |          |         |      |         |
|--|----------|---------|------|---------|
| TS2-2/M12 Pole clamp, double (Ø 114-133) | 147-0546 | 114-133 | 1.60 | 114-133 |
|--|----------|---------|------|---------|

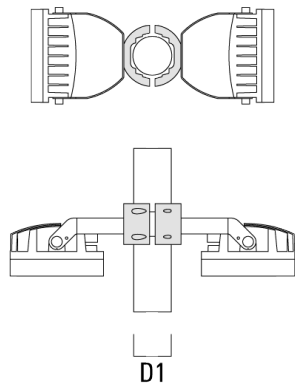

| Description                              | Part ID  | D1      | Weight (kg) | D       |
|--|----------|---------|-------------|---------|
| TS2-2/M12 Pole clamp, double (Ø 102-114) | 147-0527 | 102-114 | 1.50        | 102-114 |

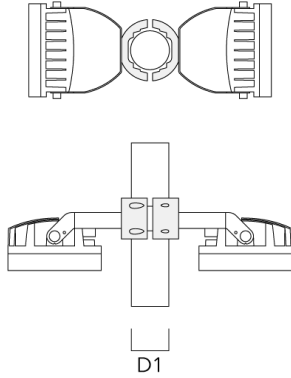

**Planted root**

| Description       | Part ID  | D1  | D2  | D3  | D4  | H1  | H2  | M1 | Weight (kg) |
|-------------------|----------|-----|-----|-----|-----|-----|-----|----|-------------|
| Planted root ESV4 | 300-0461 | 145 | 130 | 102 | 108 | 400 | 350 | 8  | 7.05        |

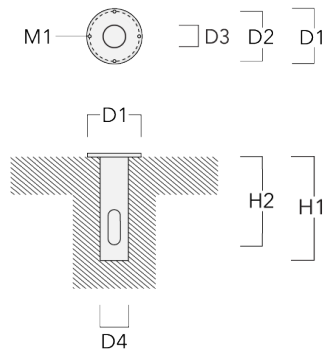

## Pole clamp PC

| Description                               | Part ID  | D1    | Weight (kg) |
|---|----------|-------|-------------|
| PC2 76-89/60 Pole clamp, double (Ø 76-89) | 139-2703 | 76-89 | 1.00        |

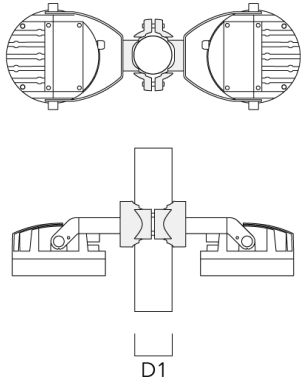

|   |          |       |      |
|---|----------|-------|------|
| PC1 76-89/60 Pole clamp, single (Ø 76-89) | 139-2702 | 76-89 | 1.00 |
|---|----------|-------|------|

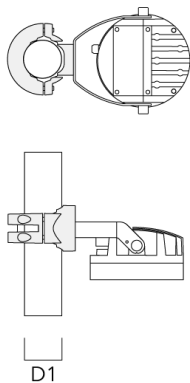

| Description                                      | Part ID  | D1      | Weight (kg) |
|--|----------|---------|-------------|
| PC2 102-114/60 Pole clamp, double<br>(Ø 102-114) | 139-2707 | 102-114 | 1.20        |



|  |          |         |      |
|--|----------|---------|------|
| PC1 102-114/60 Pole clamp, single<br>(Ø 102-114) | 139-2706 | 102-114 | 1.20 |
|--|----------|---------|------|

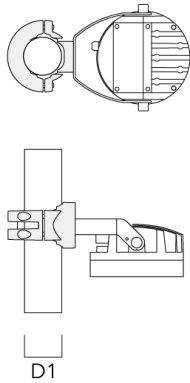

| Description                                      | Part ID  | D1      | Weight (kg) |
|--|----------|---------|-------------|
| PC2 114-133/60 Pole clamp, double<br>(Ø 114-133) | 139-2709 | 114-133 | 1.40        |



|  |          |         |      |
|--|----------|---------|------|
| PC1 114-133/60 Pole clamp, single<br>(Ø 114-133) | 139-2708 | 114-133 | 1.40 |
|--|----------|---------|------|

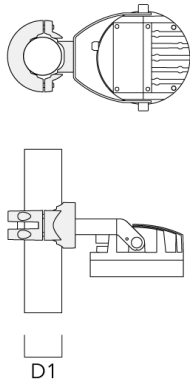

| Description                                | Part ID  | D1     | Weight (kg) |
|--|----------|--------|-------------|
| PC2 82-109/60 Pole camp, double (Ø 82-109) | 139-2705 | 82-109 | 1.10        |

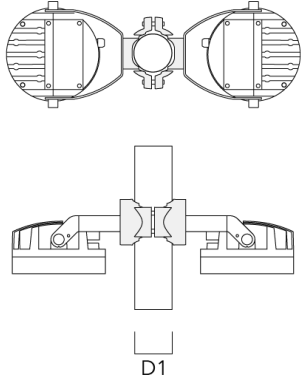

|  |          |        |      |
|--|----------|--------|------|
| PC1 82-109/60 Pole camp, single (Ø 82-109) | 139-2704 | 82-109 | 1.10 |
|--|----------|--------|------|

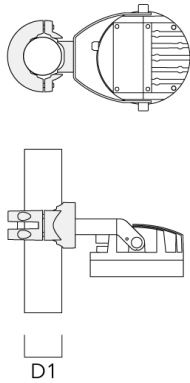



**139-1911**

**FLC230 LED**

**we-ef**

## **Control**

### **Eco Step Dim® Basic**

| Description             | Part ID  |
|-------------------------|----------|
| Eco Step Dim® Basic LED | 430-0001 |

### **Eco Step Dim® Advanced**

| Description                | Part ID  |
|----------------------------|----------|
| Eco Step Dim® Advanced LED | 430-0002 |

### **R2C Ready to Connect**

| Description                | Part ID  |
|----------------------------|----------|
| R2C Ready to Connect (top) | 430-0019 |

### Optical Accessories

#### Linear spread lens

---

| Description       | Part ID  | C1  |
|-------------------|----------|-----|
| IO-180-FLC230-LED | 139-1849 | 199 |

---

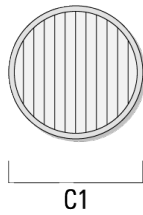

---

#### Flood lens

---

| Description       | Part ID  | C1  |
|-------------------|----------|-----|
| IO-360-FLC230-LED | 139-1850 | 199 |

---

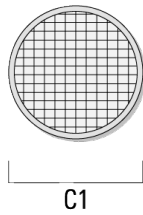

**Honeycomb louvre**

| Description                  | Part ID  | C1  |
|------------------------------|----------|-----|
| IW-FLC230-LED - [E][EE][EES] | 139-1851 | 199 |

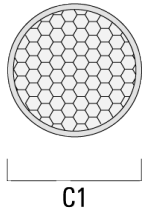

**Glare shield**

| Description   | Part ID  | A   | C1  |
|---------------|----------|-----|-----|
| ES-FLC230-LED | 139-1852 | 159 | 266 |

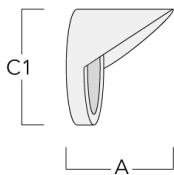

139-1911

FLC230 LED

**we-ef**

**Snoot**

---

| Description   | Part ID  | A   | C1  |
|---------------|----------|-----|-----|
| ET-FLC230-LED | 139-1853 | 160 | 266 |

---

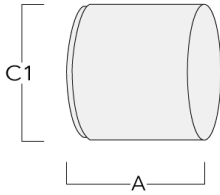

---

**Wallwash lens**

---

| Description      | Part ID  | C1  |
|------------------|----------|-----|
| IO-20-FLC230-LED | 139-1848 | 199 |

---

