

139-1931

FLC240-CC LED

we-ef



Description

Changement de couleurs RGBW/RGBA. IP66. Classe I. IK07. Corps en fonte d'aluminium. Visserie inox avec traitement PCS. Protection contre la corrosion 5CE. Joint silicone. Verre de sécurité. LED contrôlables par système DMX.

Technologie sans fil DMX Wireless disponible.

Poids	13.80 kg
Types photométries	faisceau symétrique, extensif [B]
Type de Lampes	LED-24/96W - RGBW/4K
IRC	20/80
Alimentation électrique	ballast électronique
LEDs	24
Rated input power	100 W
Flux lumineux nominal (lm)	
LED Lumen	340
Total Lumen	8160
Tj	85
Rated lumens (lm)	
LED Lumen	248.6
Total Lumen	5966.1
Ta	25

WE-EF LUMIERE

ZAC de Chesnes Nord, 6 Rue de Brisson, CS80330, 38290 Satolas et Bonce - Téléphone: +33 4 74 99 14 44
info.france@we-ef.com - <https://we-ef.com/fr>

Sous réserve de modifications techniques et d'erreurs. - Généré le 10/03/2025

139-1931

FLC240-CC LED

we-ef

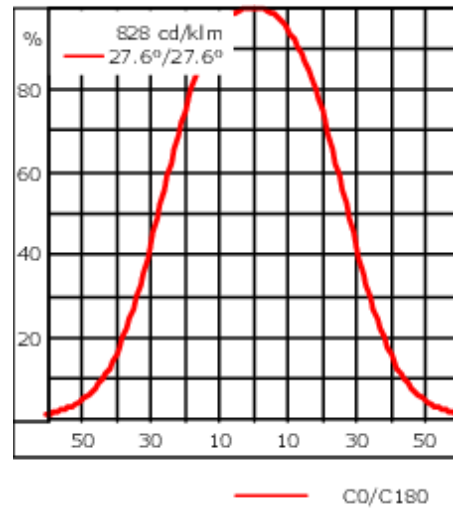
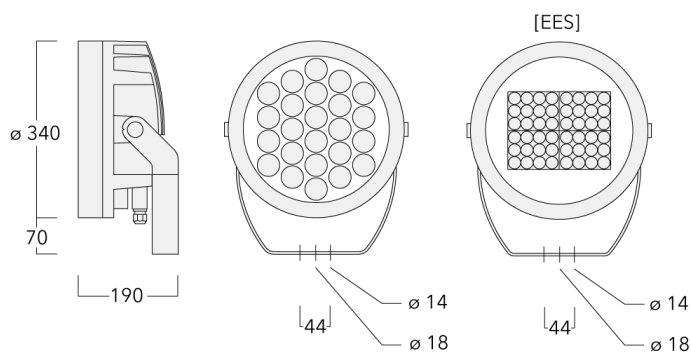

Spécifications

Description du matériel

Corps	Corps en fonte d'aluminium
Lentille	Verre de sécurité
Couleurs	Peinture poudre disponible avec 35 couleurs différents
Joint	Joint silicone CCG®
Visserie	Visserie inox avec traitement PCS
IP	IP66
IK	IK07
Protection contre la corrosion	5CE
Surface exposée au vent	0.090 m ²

Description électrique

Driver	DMX
Power factor	> 0.9

Informations complémentaires

Durée de vie	Ta=25° L90B10 > 90000h
--------------	------------------------

WE-EF LUMIERE

ZAC de Chesnes Nord, 6 Rue de Brisson, CS80330, 38290 Satolas et Bonce - Téléphone: +33 4 74 99 14 44

info.france@we-ef.com - <https://we-ef.com/fr>

Sous réserve de modifications techniques et d'erreurs. - Généré le 10/03/2025

Accessoires d'installation

Traverse pour mâts

Description	Code produit	A	C1	D x L1	Poids (kg)	D x S
TA1 traverse simple (Ø 76 x 200)	147-0023		130	76 x 200	1.90	76 x 200

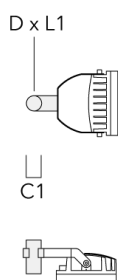

TA2 traverse double (Ø 76 x 200)	147-0024		130	76 x 200	1.90	76 x 200
----------------------------------	----------	--	-----	----------	------	----------

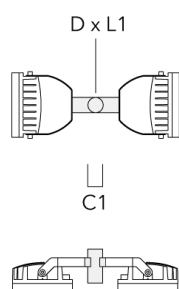

Description	Code produit	A	C1	D x L1	Poids (kg)	D x S
TA2-L traverse longue orientable (Ø 76 x 200)	147-0105	±90°	420	76 x 200	16.10	76 x 200

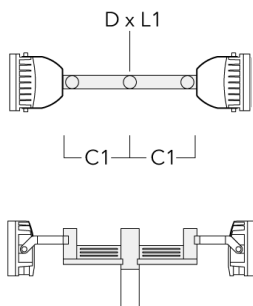

TA3 traverse triple orientable (Ø 89 x 200)	147-0025	±90°	650	89 x 200	17.90	89 x 200
---	----------	------	-----	----------	-------	----------

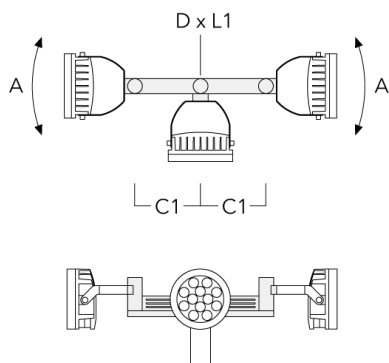
**WE-EF LUMIERE**

ZAC de Chesnes Nord, 6 Rue de Brisson, CS80330, 38290 Satolas et Bonce - Téléphone: +33 4 74 99 14 44
 info.france@we-ef.com - <https://we-ef.com/fr>

Sous réserve de modifications techniques et d'erreurs. - Généré le 10/03/2025

Description	Code produit	A	C1	D x L1	Poids (kg)	D x S
TA4 Traverse pour 4 projecteurs (Ø 89 x 200)	147-0099	±90°	650	89 x 200	20.80	89 x 200



TA1 traverse simple (Ø 108 x 200)	147-0096		130	108 x 200	7.50	108 x 200
-----------------------------------	----------	--	-----	-----------	------	-----------

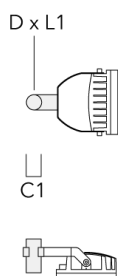

Description	Code produit	A	C1	D x L1	Poids (kg)	D x S
TA2 traverse double (Ø 108 x 200)	147-0097		130	108 x 200	7.50	108 x 200

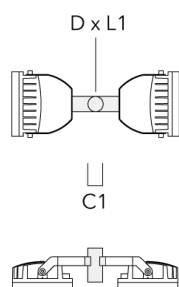

TA2-L traverse longue orientable (Ø 108 x 200)	147-0148	±90°	420	108 x 200	20.20	108 x 200
--	----------	------	-----	-----------	-------	-----------

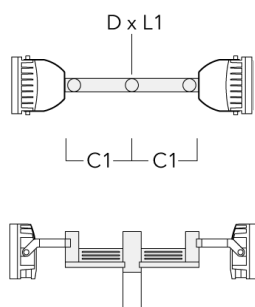
**WE-EF LUMIERE**

ZAC de Chesnes Nord, 6 Rue de Brisson, CS80330, 38290 Satolas et Bonce - Téléphone: +33 4 74 99 14 44
 info.france@we-ef.com - <https://we-ef.com/fr>

Sous réserve de modifications techniques et d'erreurs. - Généré le 10/03/2025

Description	Code produit	A	C1	D x L1	Poids (kg)	D x S
TA3 traverse triple orientable (Ø 108 x 200)	147-0098	±90°	650	108 x 200	24.20	108 x 200

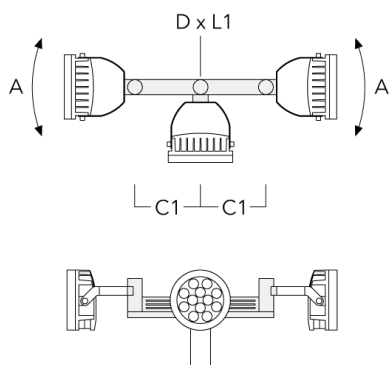

TA4 Traverse pour 4 projecteurs (Ø 108 x 200)	147-0100	±90°	650	108 x 200	24.20	108 x 200
---	----------	------	-----	-----------	-------	-----------

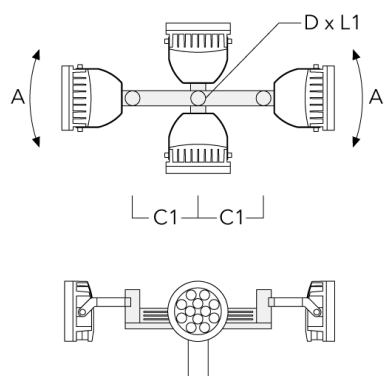
**WE-EF LUMIERE**

ZAC de Chesnes Nord, 6 Rue de Brisson, CS80330, 38290 Satolas et Bonce - Téléphone: +33 4 74 99 14 44
 info.france@we-ef.com - <https://we-ef.com/fr>

Sous réserve de modifications techniques et d'erreurs. - Généré le 10/03/2025

Collier pour mâts TS

Description	Code produit	D1	Poids (kg)	D
TS1-2/M12 collier simple pour tube (Ø 76-89)	147-0543	76-89	1.40	76-89

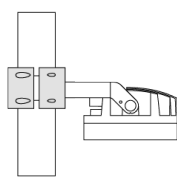
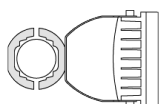

D1

TS1-2/M12 collier simple pour tube (Ø 102-114)	147-0526	102-114	1.50	102-114
--	----------	---------	------	---------

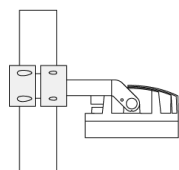
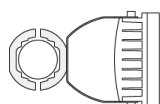

D1

WE-EF LUMIERE

ZAC de Chesnes Nord, 6 Rue de Brisson, CS80330, 38290 Satolas et Bonce - Téléphone: +33 4 74 99 14 44
info.france@we-ef.com - <https://we-ef.com/fr>

Sous réserve de modifications techniques et d'erreurs. - Généré le 10/03/2025

Description	Code produit	D1	Poids (kg)	D
TS1-2/M12 collier simple pour tube (Ø 114-133)	147-0544	114-133	1.70	114-133

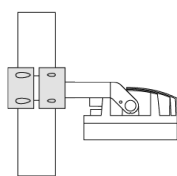

D1

TS2-2/M12 collier double pour tube (Ø 76-89)	147-0545	76-89	1.40	76-89
---	----------	-------	------	-------

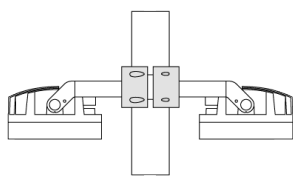
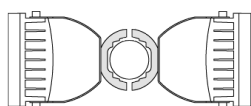

D1

Description	Code produit	D1	Poids (kg)	D
TS2-2/M12 collier double pour tube (Ø 102-114)	147-0527	102-114	1.50	102-114

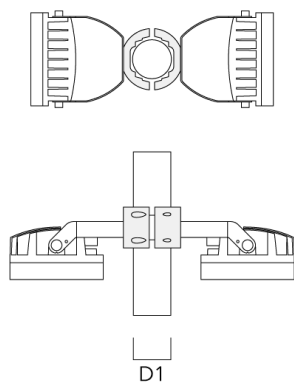

TS2-2/M12 collier double pour tube (Ø 114-133)	147-0546	114-133	1.60	114-133
---	----------	---------	------	---------

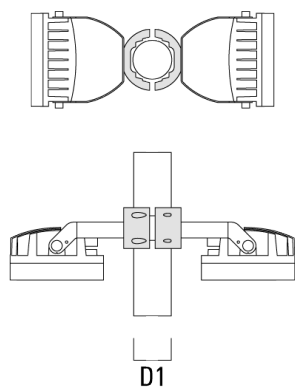

Collier pour mâts PC

Description	Code produit	D1	Poids (kg)
PC2 76-89/60 collier double pour tube (Ø 76-89)	139-2703	76-89	1.00

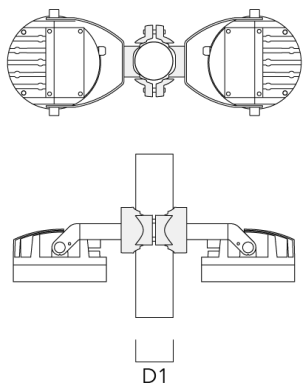

PC1 76-89/60 collier simple (Ø 76-89)	139-2702	76-89	1.00
---------------------------------------	----------	-------	------

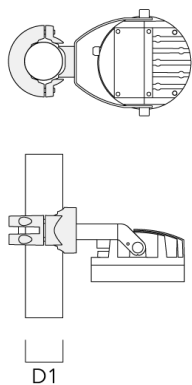

139-1931

FLC240-CC LED

we-ef

Description	Code produit	D1	Poids (kg)
PC2 102-114/60 collier double pour tube (Ø 102-114)	139-2707	102-114	1.20

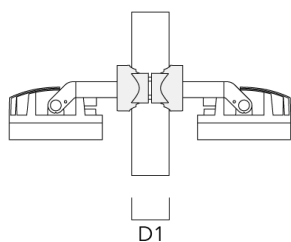
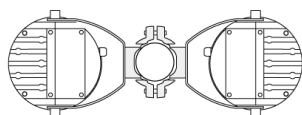

PC1 102-114/60 collier simple (Ø 102-114)	139-2706	102-114	1.20
---	----------	---------	------

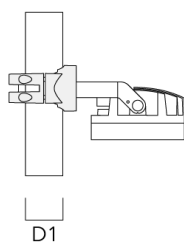

WE-EF LUMIERE

ZAC de Chesnes Nord, 6 Rue de Brisson, CS80330, 38290 Satolas et Bonce - Téléphone: +33 4 74 99 14 44
info.france@we-ef.com - <https://we-ef.com/fr>

Sous réserve de modifications techniques et d'erreurs. - Généré le 10/03/2025

Description	Code produit	D1	Poids (kg)
PC2 114-133/60 collier double pour tube (Ø 114-133)	139-2709	114-133	1.40



PC1 114-133/60 collier simple (Ø 114-133)	139-2708	114-133	1.40
---	----------	---------	------



Description	Code produit	D1	Poids (kg)
PC2 82-109/60 collier double pour tube (Ø 82-109)	139-2705	82-109	1.10



PC1 82-109/60 collier simple (Ø 82-109)	139-2704	82-109	1.10
---	----------	--------	------

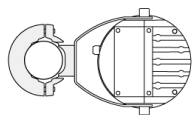

139-1931

FLC240-CC LED

we-ef

Accessoires Optiques

Lentille ovalisante

Description	Code produit	C1
Linear spread lens IO-180	139-1855	289

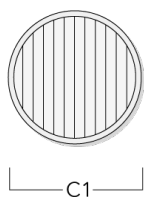

Canon anti-éblouissement

Description	Code produit	A	C1
ET-FLC240-LED	139-1859	200	346

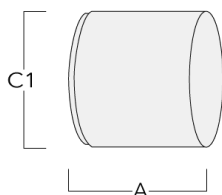

WE-EF LUMIERE

ZAC de Chesnes Nord, 6 Rue de Brisson, CS80330, 38290 Satolas et Bonce - Téléphone: +33 4 74 99 14 44
info.france@we-ef.com - <https://we-ef.com/fr>

Sous réserve de modifications techniques et d'erreurs. - Généré le 10/03/2025

139-1931

FLC240-CC LED

we-ef

Visière

Description	Code produit	A	C1
ES-FLC240-LED	139-1858	200	346

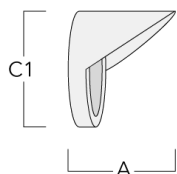

Lentille e'largissante

Description	Code produit	C1
IO-360-FLC240-LED	139-1856	289

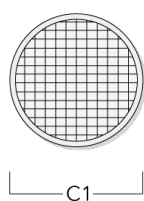

WE-EF LUMIERE

ZAC de Chesnes Nord, 6 Rue de Brisson, CS80330, 38290 Satolas et Bonce - Téléphone: +33 4 74 99 14 44
info.france@we-ef.com - <https://we-ef.com/fr>

Sous réserve de modifications techniques et d'erreurs. - Généré le 10/03/2025

139-1931

FLC240-CC LED

we-ef

Grille nid d'abeille

Description	Code produit	C1
Honeycomb Louvre IW	139-1857	279



WE-EF LUMIERE

ZAC de Chesnes Nord, 6 Rue de Brisson, CS80330, 38290 Satolas et Bonce - Téléphone: +33 4 74 99 14 44
info.france@we-ef.com - <https://we-ef.com/fr>

Sous réserve de modifications techniques et d'erreurs. - Généré le 10/03/2025

139-1931

FLC240-CC LED

we-ef

Control

DMX Controller

Description	Code produit
DMX Controller	400-0469

DMX Controller (smart)

Description	Code produit	Informations complémentaires
DMX Controller (smart)	400-0470	IP20. The Touch Panel is an intuitive and easy-to-use keypad for one DMX universe. It can store up to 36 scenes; alternatively, via



WE-EF LUMIERE

ZAC de Chesnes Nord, 6 Rue de Brisson, CS80330, 38290 Satolas et Bonce - Téléphone: +33 4 74 99 14 44
info.france@we-ef.com - <https://we-ef.com/fr>

Sous réserve de modifications techniques et d'erreurs. - Généré le 10/03/2025

139-1931

FLC240-CC LED

we-ef

DMX Controller - RDM ready

Description	Code produit
DMX Controller - RDM ready	400-0471



DMX Splitter

Description	Code produit
DMX Splitter	400-0473



WE-EF LUMIERE

ZAC de Chesnes Nord, 6 Rue de Brisson, CS80330, 38290 Satolas et Bonce - Téléphone: +33 4 74 99 14 44
info.france@we-ef.com - <https://we-ef.com/fr>

Sous réserve de modifications techniques et d'erreurs. - Généré le 10/03/2025

139-1931

FLC240-CC LED

we-ef

DMX Booster Box

Description	Code produit
DMX Booster Box	400-0474



DMX Motion Sensor

Description	Code produit
DMX Motion Sensor	400-0478



WE-EF LUMIERE

ZAC de Chesnes Nord, 6 Rue de Brisson, CS80330, 38290 Satolas et Bonce - Téléphone: +33 4 74 99 14 44
info.france@we-ef.com - <https://we-ef.com/fr>

Sous réserve de modifications techniques et d'erreurs. - Généré le 10/03/2025

139-1931

FLC240-CC LED

we-ef

DMX Termination Plug

Description	Code produit
DMX Termination Plug	400-0475



DMX Plug and Socket

Description	Code produit
DMX Plug and Socket	400-0479



WE-EF LUMIERE

ZAC de Chesnes Nord, 6 Rue de Brisson, CS80330, 38290 Satolas et Bonce - Téléphone: +33 4 74 99 14 44
info.france@we-ef.com - <https://we-ef.com/fr>

Sous réserve de modifications techniques et d'erreurs. - Généré le 10/03/2025

139-1931

FLC240-CC LED

we-ef

DMX Combination Cable

Description	Code produit
DMX Combination Cable	400-0480



DMX Wireless Repeater

Description	Code produit
DMX Wireless Repeater	400-0477



WE-EF LUMIERE

ZAC de Chesnes Nord, 6 Rue de Brisson, CS80330, 38290 Satolas et Bonce - Téléphone: +33 4 74 99 14 44
info.france@we-ef.com - <https://we-ef.com/fr>

Sous réserve de modifications techniques et d'erreurs. - Généré le 10/03/2025

139-1931

FLC240-CC LED

we-ef

DMX Wireless Transceiver

Description	Code produit
DMX Wireless Transceiver	400-0476



DMX Controller (smart) - RDM ready

Description	Code produit
DMX Controller (smart) - RDM ready	400-0472



R2C Ready to Connect

Description	Code produit
R2C Ready to Connect (top)	430-0019

WE-EF LUMIERE

ZAC de Chesnes Nord, 6 Rue de Brisson, CS80330, 38290 Satolas et Bonce - Téléphone: +33 4 74 99 14 44
info.france@we-ef.com - <https://we-ef.com/fr>

Sous réserve de modifications techniques et d'erreurs. - Généré le 10/03/2025