

139-1929

FLC230-CC LED

we-ef



Description

Changement de couleurs RGBW/RGBA. IP66. Classe I. Classe II sur demande. IK07. Corps en fonte d'aluminium. Visserie inox avec traitement PCS. Protection contre la corrosion 5CE. Joint silicone. Verre de sécurité. LED contrôlables par système DMX. Technologie sans fil DMX Wireless disponible.

Poids	7.70 kg
Distribution de la lumière	faisceau symétrique, extensif [B]
Source lumineuse	LED-12/48W - RGBW/4K
IRC	20/80
Alimentation électrique	ballast électronique
LEDs	12
Rated input power	50 W
Flux lumineux nominal (lm)	
LED Lumen	340
Total Lumen	4080
Tj	85
Rated lumens (lm)	
LED Lumen	248.6
Total Lumen	2983
Ta	25

WE-EF Switzerland AG

Himmelrichstrasse 6, 6003 Luzern - Téléphone: +41 22 752 49 94
info.switzerland@we-ef.com - https://we-ef.com/ch_fr

Sous réserve de modifications techniques et d'erreurs. - Généré le 10/03/2025

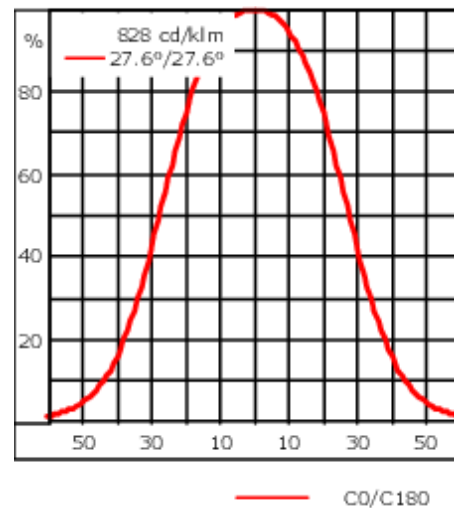
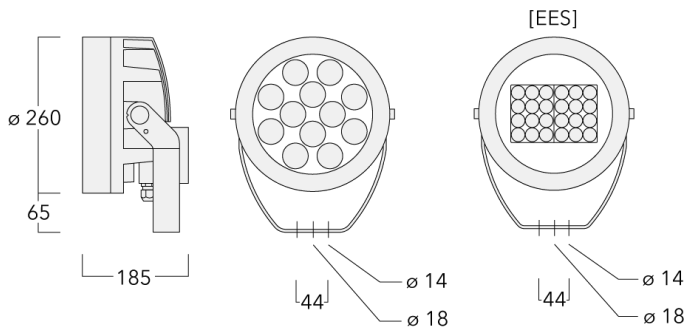

Spécifications

Description du matériel

Corps	Corps en fonte d'aluminium
Lentille	Verre de sécurité
Couleurs	<div style="display: flex; align-items: center;"> <div style="width: 20px; height: 15px; background-color: black; margin-right: 5px;"></div> RAL9004 Noir de sécurité </div> <div style="display: flex; align-items: center; margin-top: 5px;"> <div style="width: 20px; height: 15px; background-color: gray; margin-right: 5px;"></div> RAL9007 Aluminium gris </div> <div style="display: flex; align-items: center; margin-top: 5px;"> <div style="width: 20px; height: 15px; background-color: darkgray; margin-right: 5px;"></div> RAL7016 Gris anthracite </div> <div style="display: flex; align-items: center; margin-top: 5px;"> <div style="width: 20px; height: 15px; background-color: lightgray; margin-right: 5px;"></div> RAL9016 Blanc signalisation </div>
Joint	Joint silicone CCG®
Visserie	PCS Inox avec revêtement polymère
IP	IP66
IK	IK07
Protection contre la corrosion	5CE
Surface exposée au vent	0.054 m ²

Description électrique

Alimentation électrique	220-240V / 50-60 Hz
Driver	DMX
Power factor	> 0.9

WE-EF Switzerland AG

Himmelrichstrasse 6, 6003 Luzern - Téléphone: +41 22 752 49 94

info.switzerland@we-ef.com - https://we-ef.com/ch_fr

Sous réserve de modifications techniques et d'erreurs. - Généré le 10/03/2025

139-1929

FLC230-CC LED

we-ef

Informations complémentaires

Durée de vie Ta=25° L90B10 > 90000h

Classe d'efficacité
énergétique G

WE-EF Switzerland AG

Himmelrichstrasse 6, 6003 Luzern - Téléphone: +41 22 752 49 94

info.switzerland@we-ef.com - https://we-ef.com/ch_fr

Sous réserve de modifications techniques et d'erreurs. - Généré le 10/03/2025

Control

Eco Step Dim® Basic

Description	Référence
Eco Step Dim® Basic LED	430-0001

Eco Step Dim® Advanced

Description	Référence
Eco Step Dim® Advanced LED	430-0002

DMX Controller

Description	Référence
DMX Controller	400-0469

DMX Controller (smart)

Description	Référence	Informations complémentaires
DMX Controller (smart)	400-0470	IP20. The Touch Panel is an intuitive and easy-to-use keypad or one DMX universe. It can store up to 36 scenes; alternatively, via



DMX Controller - RDM ready

Description	Référence
DMX Controller - RDM ready	400-0471

**DMX Splitter**

Description	Référence
DMX Splitter	400-0473

**WE-EF Switzerland AG**

Himmelrichstrasse 6, 6003 Luzern - Téléphone: +41 22 752 49 94

info.switzerland@we-ef.com - https://we-ef.com/ch_fr

Sous réserve de modifications techniques et d'erreurs. - Généré le 10/03/2025

DMX Booster Box

Description	Référence
DMX Booster Box	400-0474

**DMX Motion Sensor**

Description	Référence
DMX Motion Sensor	400-0478



DMX Termination Plug

Description	Référence
DMX Termination Plug	400-0475

**DMX Plug and Socket**

Description	Référence
DMX Plug and Socket	400-0479



DMX Combination Cable

Description	Référence
DMX Combination Cable	400-0480

**DMX Wireless Repeater**

Description	Référence
DMX Wireless Repeater	400-0477



DMX Wireless Transceiver

Description	Référence
DMX Wireless Transceiver	400-0476

**DMX Controller (smart) - RDM ready**

Description	Référence
DMX Controller (smart) - RDM ready	400-0472

**R2C Ready to Connect**

Description	Référence
R2C Ready to Connect (top)	430-0019

WE-EF Switzerland AG

Himmelrichstrasse 6, 6003 Luzern - Téléphone: +41 22 752 49 94

info.switzerland@we-ef.com - https://we-ef.com/ch_fr

Sous réserve de modifications techniques et d'erreurs. - Généré le 10/03/2025

DMX Wireless Antenna

Description	Référence
Antenne RF 5dB	430-0036
Antenne RF1.8 dB	430-0018

Accessoires d'installation

Traverse pour mâts

Description	Référence	A	C1	D x L1	Poids (kg)	D x S
TA1 traverse simple (Ø 108 x 200)	147-0096		130	108 x 200	7.50	108 x 200

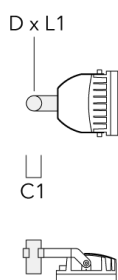

TA2 traverse double (Ø 108 x 200)	147-0097		130	108 x 200	7.50	108 x 200
-----------------------------------	----------	--	-----	-----------	------	-----------

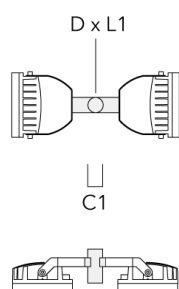

FLC230-CC LED

Description	Référence	A	C1	D x L1	Poids (kg)	D x S
TA2-L traverse longue orientable (Ø 108 x 200)	147-0148	±90°	420	108 x 200	20.20	108 x 200

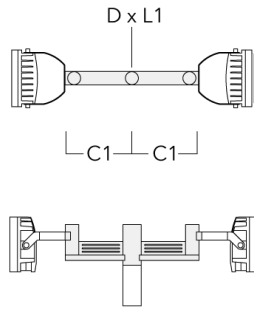

TA2-L traverse longue orientable (Ø 76 x 200)	147-0105	±90°	420	76 x 200	16.10	76 x 200
---	----------	------	-----	----------	-------	----------

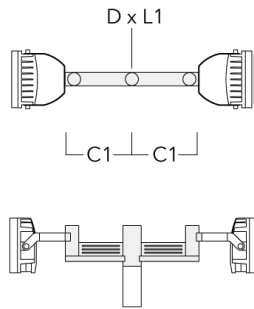

FLC230-CC LED

Description	Référence	A	C1	D x L1	Poids (kg)	D x S
TA3 traverse triple orientable (Ø 89 x 200)	147-0025	±90°	650	89 x 200	17.90	89 x 200



TA3 traverse triple orientable (Ø 108 x 200)	147-0098	±90°	650	108 x 200	24.20	108 x 200
--	----------	------	-----	-----------	-------	-----------



FLC230-CC LED

Description	Référence	A	C1	D x L1	Poids (kg)	D x S
TA4-L Traverse pour 4 projecteurs (Ø 89 x 200)	147-0099	±90°	650	89 x 200	20.80	89 x 200

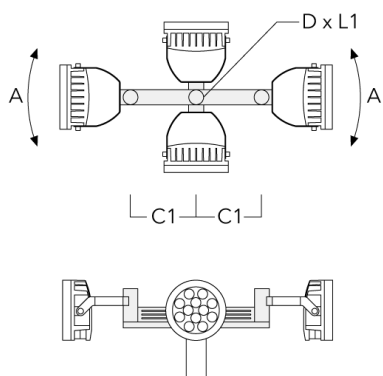

TA4 Traverse pour 4 projecteurs (Ø 108 x 200)	147-0100	±90°	650	108 x 200	24.20	108 x 200
---	----------	------	-----	-----------	-------	-----------

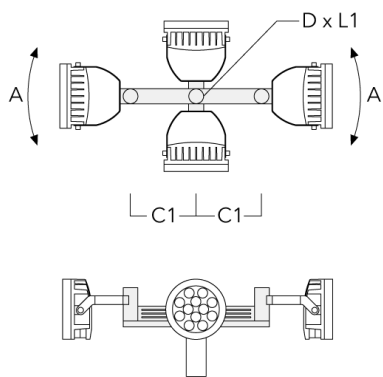

Description	Référence	A	C1	D x L1	Poids (kg)	D x S
TA2 traverse double (Ø 76 x 200)	147-0024		130	76 x 200	1.90	76 x 200

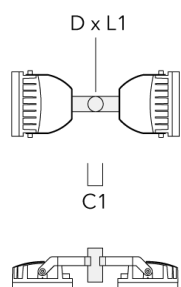

TA1 traverse simple (Ø 76 x 200)	147-0023		130	76 x 200	1.50	76 x 200
----------------------------------	----------	--	-----	----------	------	----------

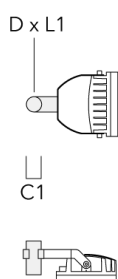

Collier pour mâts TS

Description	Référence	D1	Poids (kg)	D
TS1-2/M12 collier simple pour tube (Ø 102-114)	147-0526	102-114	1.50	102-114

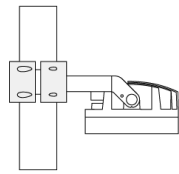
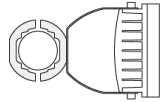

D1

TS1-2/M12 collier simple pour tube (Ø 114-133)	147-0544	114-133	1.70	114-133
--	----------	---------	------	---------

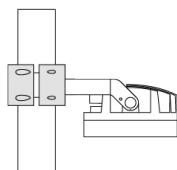
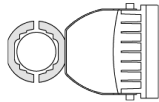

D1

FLC230-CC LED

Description	Référence	D1	Poids (kg)	D
TS1-2/M12 collier simple pour tube (Ø 76-89)	147-0543	76-89	1.40	76-89

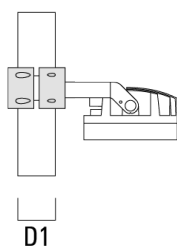

TS2-2/M12 collier double pour tube (Ø 76-89)	147-0545	76-89	1.40	76-89
---	----------	-------	------	-------

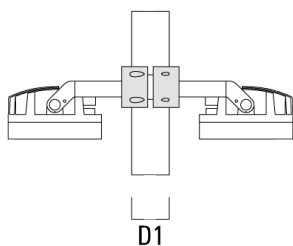
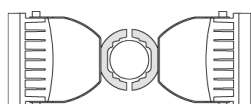

FLC230-CC LED

Description	Référence	D1	Poids (kg)	D
TS2-2/M12 collier double pour tube (Ø 114-133)	147-0546	114-133	1.60	114-133

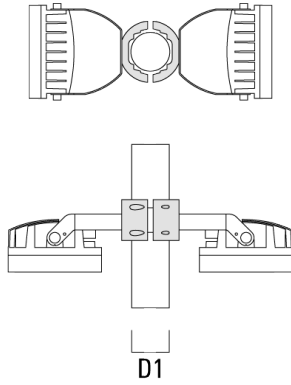

TS2-2/M12 collier double pour tube (Ø 102-114)	147-0527	102-114	1.50	102-114
---	----------	---------	------	---------

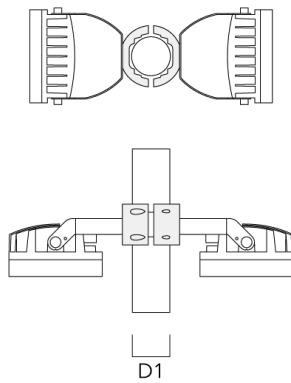

Base à enterrer

Description	Référence	D1	D2	D3	D4	H1	H2	M1	Poids (kg)
Base à enterrer ESV4	300-0461	145	130	102	108	400	350	8	7.05

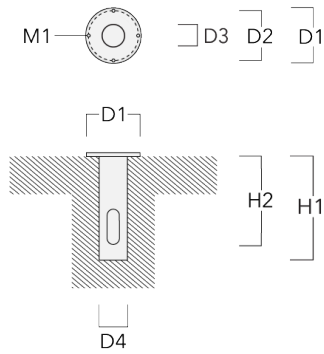

Collier pour mâts PC

Description	Référence	D1	Poids (kg)
PC2 76-89/60 collier double pour tube (Ø 76-89)	139-2703	76-89	1.00

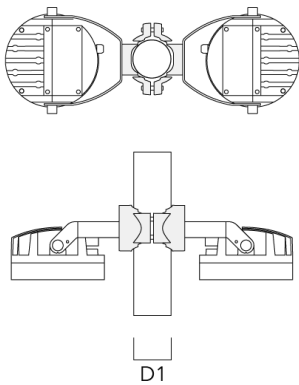

FLC230-CC LED

Description	Référence	D1	Poids (kg)
PC1 76-89/60 collier simple (Ø 76-89)	139-2702	76-89	1.00



PC2 102-114/60 collier double pour tube (Ø 102-114)	139-2707	102-114	1.20
---	----------	---------	------

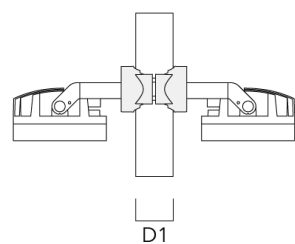
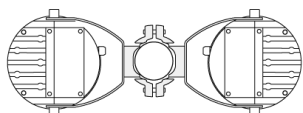

FLC230-CC LED

Description	Référence	D1	Poids (kg)
PC1 102-114/60 collier simple (Ø 102-114)	139-2706	102-114	1.20



PC2 114-133/60 collier double pour tube (Ø 114-133)	139-2709	114-133	1.40
---	----------	---------	------

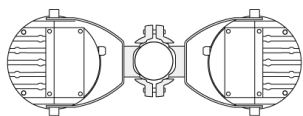

FLC230-CC LED

Description	Référence	D1	Poids (kg)
PC1 114-133/60 collier simple (Ø 114-133)	139-2708	114-133	1.40



PC2 82-109/60 collier double pour tube (Ø 82-109)	139-2705	82-109	1.10
---	----------	--------	------

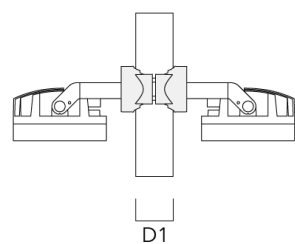
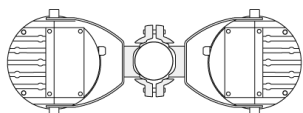

Description	Référence	D1	Poids (kg)
PC1 82-109/60 collier simple (Ø 82-109)	139-2704	82-109	1.10

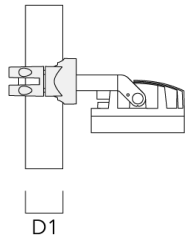
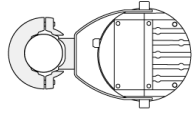

Accessoires Optiques

Visière

Description	Référence	A	C1
Visière ES	139-1852	159	266

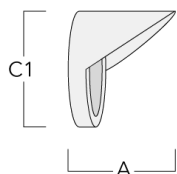

Canon anti-éblouissement

Description	Référence	A	C1
Canon anti-éblouissement ET	139-1853	160	266

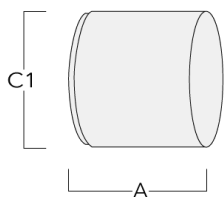

Lentille ovalisante

Description	Référence	C1
IO-180-FLC230-LED	139-1849	199

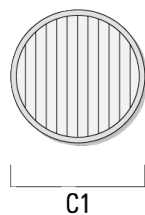
**Lentille e'largissante**

Description	Référence	C1
IO-360-FLC230-LED	139-1850	199

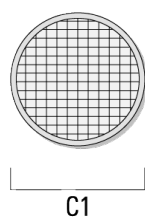

Lentille rasante

Description	Référence	C1
IO-20-FLC230-LED	139-1848	199

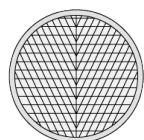

C1