

139-1913

**we-ef**

**FLC230 LED COLOR CHANGER**



**Description**

RGBW/RGBA Color Changer.

IP66. Class I. Marine-grade, die-cast aluminum alloy. 5CE superior corrosion protection including PCS hardware. Silicone CCG® Controlled Compression Gasket. Safety glass lens. Two cable glands; one for power, one for DMX. CAD-optimized optics for superior illumination and glare control. Integral driver, thermally separated. OLC® One LED Concept. Factory-installed LED circuit board. DMX interface.

Color Boost technology: With Color Boost the targeted and selective control of individual channels or colors means that a higher power of the LEDs can be accessed than in total when all colors are simultaneously operated. The light output is thus maximized by targeted control of individual channels/colors.

For the M20 cable gland for network- and DMX-connection, WE-EF recommends a multi-core cable for DMX and power, "Power PUR-SR 3x1.5 + DMX".

Specify product with 7 Digit product code - Finish Color. Accessories, such as mounting, optical, and electrical, must be specified separately.

Weight	16.76 lb
Light distribution	symmetric, medium beam [M]
Light source	LED-12/48W - RGBW/4K
CRI	80
Power supply	electronic gear
LEDs	12
Rated input power	50 W

**Nominal Lumen (lm)**

LED Lumen	340
Total Lumen	4080
Tj	85

**Delivered lumens (lm)**

LED Lumen	267.1
Total Lumen	3205
Ta	25

**WE-EF LIGHTING USA, LLC**

410-D Keystone Drive, 15086 Warrendale, PA 15086 - Phone: +1 724 742 0030  
customersupport.usa@we-ef.com - <https://we-ef.com/us>  
Subject to technical changes and errors. - Generated on 03/10/2025

**139-1913**

**we-ef**

**FLC230 LED COLOR CHANGER**

Example: XXX-XXXX-9004 (Black)  
+ XXX-XXXX (Accessory 1)

**WE-EF LIGHTING USA, LLC**

410-D Keystone Drive, 15086 Warrendale, PA 15086 - Phone: +1 724 742 0030  
customersupport.usa@we-ef.com - <https://we-ef.com/us>  
Subject to technical changes and errors. - Generated on 03/10/2025

**FLC230 LED COLOR CHANGER**

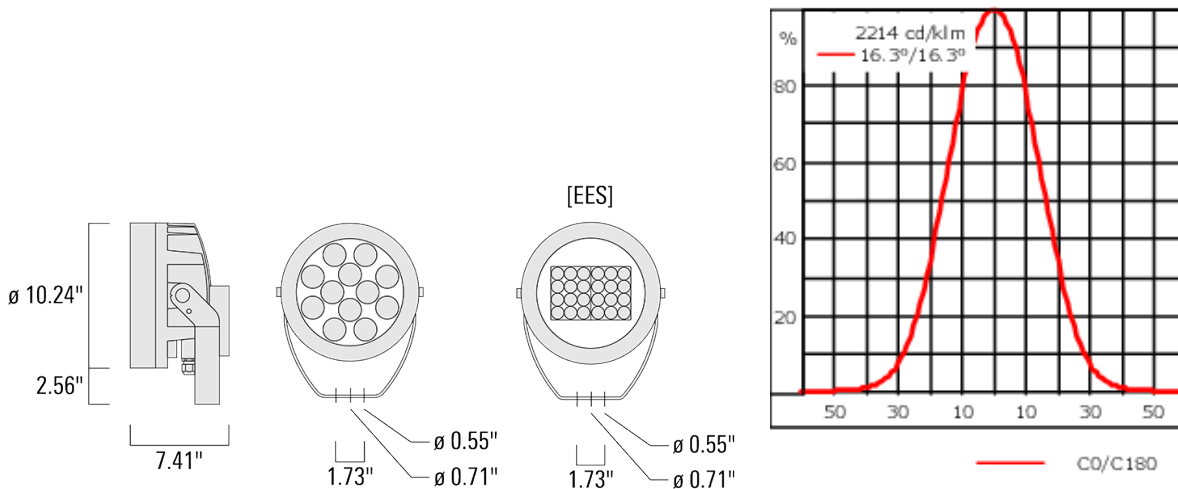

**Specifications**

**Material description**

Body	Marine-grade, die-cast aluminium alloy
Lens	Safety glass lens
Colors	<ul style="list-style-type: none"> <li><span style="display: inline-block; width: 15px; height: 15px; background-color: black; margin-right: 5px;"></span> RAL9004 Black</li> <li><span style="display: inline-block; width: 15px; height: 15px; background-color: grey; margin-right: 5px;"></span> RAL9007 Grey Metallic</li> <li><span style="display: inline-block; width: 15px; height: 15px; background-color: white; margin-right: 5px;"></span> RAL9016 White</li> <li><span style="display: inline-block; width: 15px; height: 15px; background-color: darkgrey; margin-right: 5px;"></span> RAL8019 Dark Bronze</li> </ul>
Gasket	Silicone CCG® Controlled Compression Gasket
Fasteners	PCS Polymer Coated Stainless Steel Hardware
Ingress protection	IP66
Impact resistance	IK07
Corrosion resistance	5CE superior corrosion protection system
Windage	0.684

**WE-EF LIGHTING USA, LLC**

410-D Keystone Drive, 15086 Warrendale, PA 15086 - Phone: +1 724 742 0030

customersupport.usa@we-ef.com - <https://we-ef.com/us>

Subject to technical changes and errors. - Generated on 03/10/2025

**FLC230 LED COLOR CHANGER****Electrical description**

---

Power supply	Integral [ECG] electronic driver 120V-277V.
Driver / Ballast	Integral EC electronic converter with DMX Interface
Power factor	> 0.9
Surge protection	Integral 10kV Surge Protector

---

**Additional information**

---

Lifetime	Ta=25°/40° L90B10 > 90000h
Listings	ETL, UL-1598, CSA-C22.2#250.0. Suitable for Wet Locations. Meets ANSI C136.31 - 3G Vibration Rating for Bridge and Overpass Applications.

---

**FLC230 LED COLOR CHANGER**

**Mounting Accessories**

**Floodlight mounting bracket TA**

Description	Part ID	A	C1	D × L1	L	Weight (lb)	D × S
TA1 Mounting bracket, single (Ø 4.25 x 8)	147-0096		5.12	4.25 x 8	4.25	16.53	108 x 200

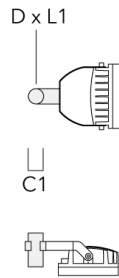

TA2 Mounting bracket, double (Ø 4.25 x 8)	147-0097		5.12	4.25 x 8	4.25	16.53	108 x 200
---	----------	--	------	----------	------	-------	-----------

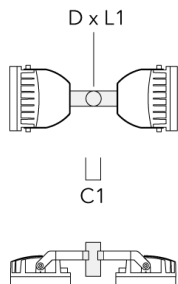

**FLC230 LED COLOR CHANGER**

Description	Part ID	A	C1	D x L1	L	Weight (lb)	D x S
TA2-L Mounting bracket, double (Ø 4.25 x 8)	147-0148	±90°	16.54	4.25 x 8	4.25	44.53	108 x 200

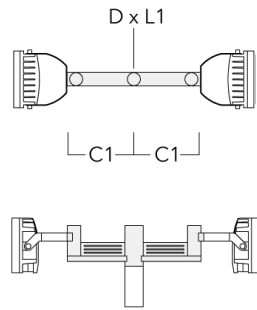

TA2-L Mounting bracket, double (Ø 3 x 8)	147-0105	±90°	16.54	3 x 8	2.99	35.49	76 x 200
--	----------	------	-------	-------	------	-------	----------

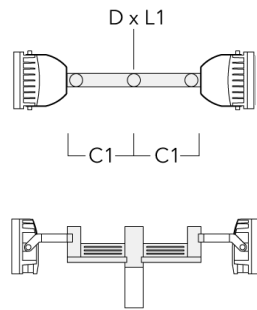

**FLC230 LED COLOR CHANGER**

Description	Part ID	A	C1	D x L1	L	Weight (lb)	D x S
TA3 Mounting bracket, triple (Ø 3.50 x 8)	147-0025	±90°	25.59	3.50 x 8	3.5	39.46	89 x 200

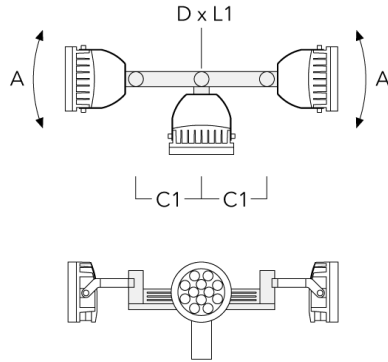

TA3 Mounting bracket, triple (Ø 4.25 x 8)	147-0098	±90°	25.59"	4.25 x 8		53.35 lbs	108 x 200
---	----------	------	--------	----------	--	-----------	-----------

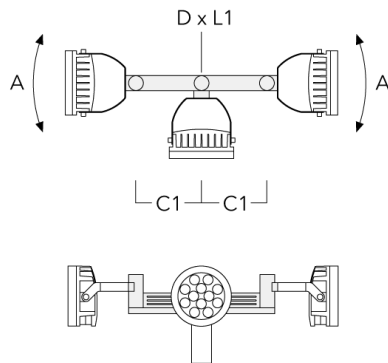

**WE-EF LIGHTING USA, LLC**

410-D Keystone Drive, 15086 Warrendale, PA 15086 - Phone: +1 724 742 0030  
 customersupport.usa@we-ef.com - <https://we-ef.com/us>  
 Subject to technical changes and errors. - Generated on 03/10/2025

**FLC230 LED COLOR CHANGER**

Description	Part ID	A	C1	D x L1	L	Weight (lb)	D x S
TA4 Mounting bracket, quad (Ø 3.50 x 8)	147-0099	±90°	25.59	3.50 x 8		45.86 lbs	89 x 200

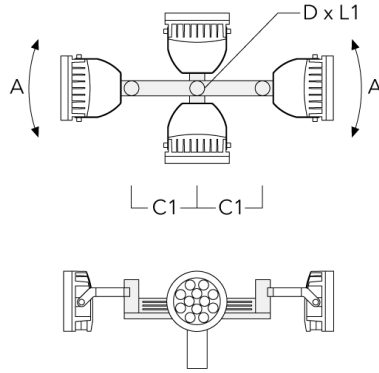

TA4 Mounting bracket, quad (Ø 4.25 x 8)	147-0100	±90°	25.59	4.25 x 8		53.00	108 x 200
---	----------	------	-------	----------	--	-------	-----------

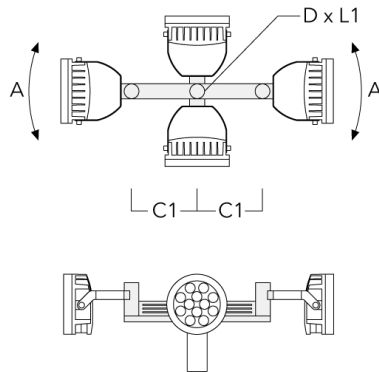

**WE-EF LIGHTING USA, LLC**

410-D Keystone Drive, 15086 Warrendale, PA 15086 - Phone: +1 724 742 0030  
 customersupport.usa@we-ef.com - <https://we-ef.com/us>

Subject to technical changes and errors. - Generated on 03/10/2025



**FLC230 LED COLOR CHANGER**

Description	Part ID	A	C1	D × L1	L	Weight (lb)	D × S
TA2 Mounting bracket, double (Ø 3 x 8)	147-0024		5.12	3 x 8	2.99	4.2 lbs	76 x 200

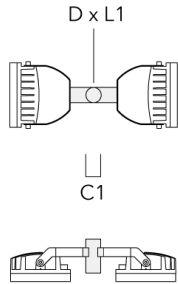

TA1 Mounting bracket, single (Ø 3 x 8)	147-0023		5.12	3 x 8	2.99	4.19	76 x 200
--	----------	--	------	-------	------	------	----------

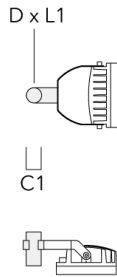

**WE-EF LIGHTING USA, LLC**

410-D Keystone Drive, 15086 Warrendale, PA 15086 - Phone: +1 724 742 0030  
 customersupport.usa@we-ef.com - <https://we-ef.com/us>  
 Subject to technical changes and errors. - Generated on 03/10/2025

**FLC230 LED COLOR CHANGER**

**Pole clamp TS**

---

Description	Part ID	D1	Weight(lb)	D
TS1-2/M12 Pole clamp, single (Ø 4.0"-4.5")	147-0526	4.0-4.50	3.53	102-114

---

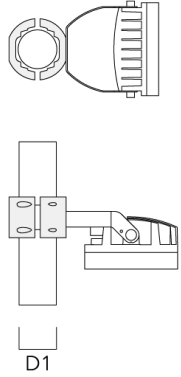

---

TS1-2/M12 Pole clamp, single (Ø 4.5"-5.25")	147-0544	114-133	3.75	114-133
---	----------	---------	------	---------

---

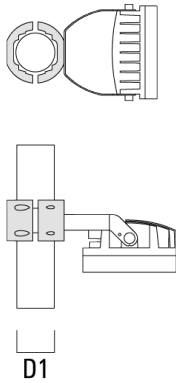

**FLC230 LED COLOR CHANGER**

---

Description	Part ID	D1	Weight (lb)	D
TS1-2/M12 Pole clamp, single (Ø 3"-3.5")	147-0543	3.0-3.50	3.31	76-89

---

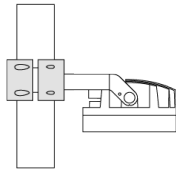
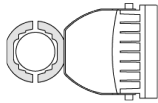

D1

---

TS2-2/M12 Pole clamp, double (Ø 3"-3.5")	147-0545	3.0"-3.5"	3.09 lbs	76-89
--	----------	-----------	----------	-------

---

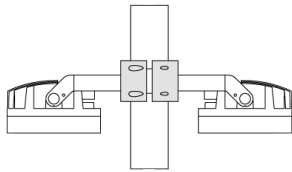
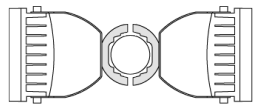

D1

**WE-EF LIGHTING USA, LLC**

410-D Keystone Drive, 15086 Warrendale, PA 15086 - Phone: +1 724 742 0030  
customersupport.usa@we-ef.com - <https://we-ef.com/us>  
Subject to technical changes and errors. - Generated on 03/10/2025

**FLC230 LED COLOR CHANGER**

Description	Part ID	D1	Weight (lb)	D
TS2-2/M16 Pole clamp, double (Ø 4.5"-5.25")	147-0546	4.50-5.25	3.53	114-133

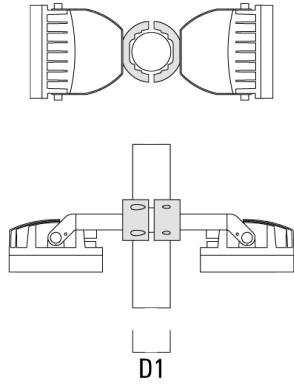

**Planted root**

Description	Part ID	D1	D2	D3	D4	H1	H2	M1	Weight (lb)
Planted root ESV4	300-0461	5.71	5.12	4.01	4.25	15.75	13.78	.31	15.54

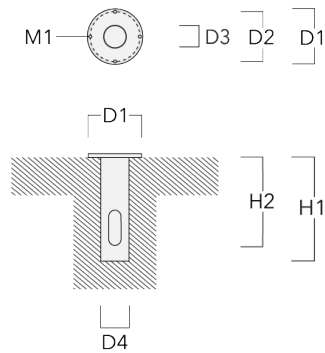

**WE-EF LIGHTING USA, LLC**

410-D Keystone Drive, 15086 Warrendale, PA 15086 - Phone: +1 724 742 0030  
 customersupport.usa@we-ef.com - <https://we-ef.com/us>  
 Subject to technical changes and errors. - Generated on 03/10/2025

**FLC230 LED COLOR CHANGER**

**Pole top caps KF**

---

Description	Part ID	D1	D × L1	Weight (lb)	D
KF16-60/M16 Spigot Cap (Ø 2.36")	310-9120	2.36	2.36 x 4	4.4 lbs	60 x 100

---

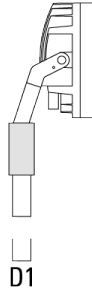

---

KF16-76/M16 Spigot Cap (Ø 3.0")	310-9121	3	3 x 4	1.10 lbs	76 x 100
---------------------------------	----------	---	-------	----------	----------

---

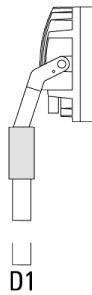

**WE-EF LIGHTING USA, LLC**

410-D Keystone Drive, 15086 Warrendale, PA 15086 - Phone: +1 724 742 0030  
customersupport.usa@we-ef.com - <https://we-ef.com/us>  
Subject to technical changes and errors. - Generated on 03/10/2025

**FLC230 LED COLOR CHANGER**

---

Description	Part ID	D1	D × L1	Weight (lb)	D
KF16-89/M16 Spigot Cap (Ø 3.5")	300-0734	3.50	3.5 x 3	1.10 lbs	89

---

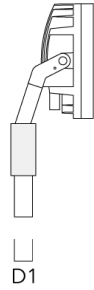

---

KF16-108/M16 Spigot Cap (Ø 4.25")	300-0735	4.25	4.25 x 3	4.4 lbs	108
-----------------------------------	----------	------	----------	---------	-----

---

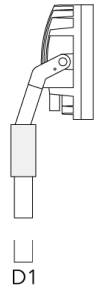

**WE-EF LIGHTING USA, LLC**

410-D Keystone Drive, 15086 Warrendale, PA 15086 - Phone: +1 724 742 0030  
customersupport.usa@we-ef.com - <https://we-ef.com/us>  
Subject to technical changes and errors. - Generated on 03/10/2025

**FLC230 LED COLOR CHANGER**

**Short post EM**

Description	Part ID	D1	D2	H1	M1	Weight (lb)
EM1-M16 AL	270-0001	6.3"	5.12"	8"	0.35"	4.85 lbs

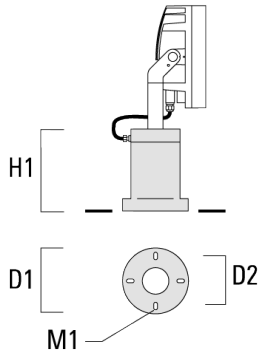

**Surface Mount Canopy SMC**

Description	Part ID	D1	D2	Weight (lb)
SMC-200	147-6915	10.83	9.25	15.4 lbs

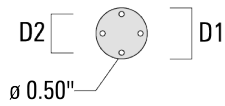

**WE-EF LIGHTING USA, LLC**

410-D Keystone Drive, 15086 Warrendale, PA 15086 - Phone: +1 724 742 0030  
 customersupport.usa@we-ef.com - <https://we-ef.com/us>  
 Subject to technical changes and errors. - Generated on 03/10/2025

**FLC230 LED COLOR CHANGER**

**Pole clamp PC**

Description	Part ID	D1	Weight (lb)
PC2 76-89/60 Pole clamp, double (Ø 3"-3.5")	139-2703	3.0-3.50	2.20

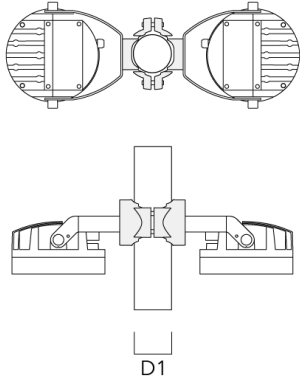

PC1 76-89/60 Pole clamp, single (Ø 3"-3.5")	139-2702	3.0-3.50	2.20
---	----------	----------	------

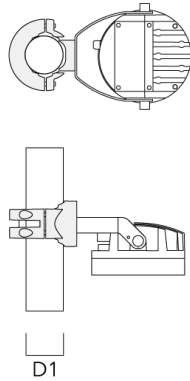

**WE-EF LIGHTING USA, LLC**

410-D Keystone Drive, 15086 Warrendale, PA 15086 - Phone: +1 724 742 0030  
 customersupport.usa@we-ef.com - <https://we-ef.com/us>  
 Subject to technical changes and errors. - Generated on 03/10/2025



**FLC230 LED COLOR CHANGER**

---

Description	Part ID	D1	Weight (lb)
PC2 102-114/60 Pole clamp, double (Ø 4"-4.5")	139-2707	4.0-4.50	2.65

---

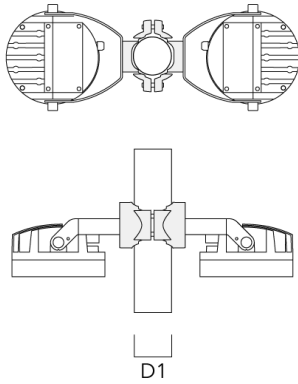

---

PC1 102-114/60 Pole clamp, single (Ø 4"-4,5")	139-2706	4.0-4.50	2.65
--	----------	----------	------

---

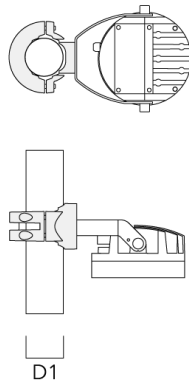

**WE-EF LIGHTING USA, LLC**

410-D Keystone Drive, 15086 Warrendale, PA 15086 - Phone: +1 724 742 0030  
customersupport.usa@we-ef.com - <https://we-ef.com/us>  
Subject to technical changes and errors. - Generated on 03/10/2025

139-1913

**we-ef**

**FLC230 LED COLOR CHANGER**

---

Description	Part ID	D1	Weight (lb)
PC2 114-133/60 Pole clamp, double (Ø 4.5"-5.25")	139-2709	4.5-5.25	3.10

---



---

PC1 114-133/60 Pole clamp, single (Ø 4.5"-5.25")	139-2708	4.5-5.25	3.10
---	----------	----------	------

---



**WE-EF LIGHTING USA, LLC**

410-D Keystone Drive, 15086 Warrendale, PA 15086 - Phone: +1 724 742 0030  
customersupport.usa@we-ef.com - <https://we-ef.com/us>  
Subject to technical changes and errors. - Generated on 03/10/2025

139-1913

**we-ef**

**FLC230 LED COLOR CHANGER**

---

Description	Part ID	D1	Weight (lb)
PC2 82-109/60 Pole clamp, double (Ø 3.25"-4.25")	139-2705	3.20-4.30	2.40

---



---

PC1 82-109/60 Pole camp, single (Ø 3.25"-4.3")	139-2704	3.20-4.30	2.40
--	----------	-----------	------

---

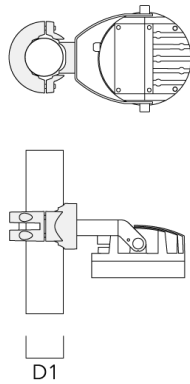

**WE-EF LIGHTING USA, LLC**

410-D Keystone Drive, 15086 Warrendale, PA 15086 - Phone: +1 724 742 0030  
customersupport.usa@we-ef.com - <https://we-ef.com/us>  
Subject to technical changes and errors. - Generated on 03/10/2025

**FLC230 LED COLOR CHANGER**

**Optical Accessories**

**Glare shield**

---

Description	Part ID	A	C1
ES-FLC230-LED	139-1852	6.26	10.47

---

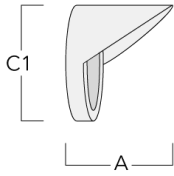

---

ES-FLC230-CC-LED	139-6970	6.29	10.47
------------------	----------	------	-------

---

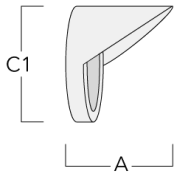

**FLC230 LED COLOR CHANGER**

**Snoot**

---

Description	Part ID	A	C1
ET-FLC230-LED	139-1853	6.3	10.47

---

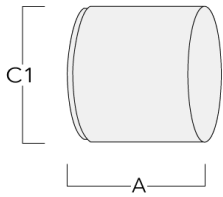

---

ET-FLC230-CC-LED	139-6974	6.29	10.47
------------------	----------	------	-------

---

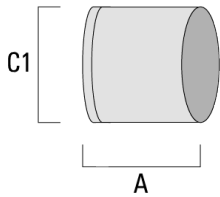

**WE-EF LIGHTING USA, LLC**

410-D Keystone Drive, 15086 Warrendale, PA 15086 - Phone: +1 724 742 0030  
customersupport.usa@we-ef.com - <https://we-ef.com/us>  
Subject to technical changes and errors. - Generated on 03/10/2025

**FLC230 LED COLOR CHANGER**

**Linear spread lens**

---

Description	Part ID	C1
IO-180-FLC230-LED	139-1849	7.80

---

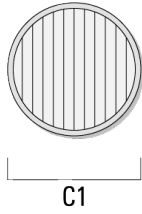

---

**Softening Lens**

---

Description	Part ID	C1
IO-360-FLC230-LED	139-1850	7.80

---

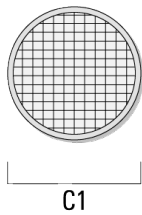

**FLC230 LED COLOR CHANGER**

**Wallwash lens**

---

Description	Part ID	C1
10-20-FLC230-LED	139-1848	7.83

---

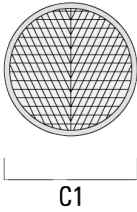

**FLC230 LED COLOR CHANGER**

**Control**

**DMX Controller**

---

Description	Part ID
DMX Controller	400-0469

---

**DMX Controller (smart)**

---

Description	Part ID	Additional information
DMX Controller (smart)	400-0470	IP20. The Touch Panel is an untutive abd easy-to use keypad or one DMX universe. It can store up to 36 scences; alternatively, via ....

---





139-1913

**we-ef**

**FLC230 LED COLOR CHANGER**

**DMX Controller - RDM ready**

---

Description	Part ID
DMX Controller - RDM ready	400-0471

---



---

**DMX Splitter**

---

Description	Part ID
DMX Splitter	400-0473

---



---

**WE-EF LIGHTING USA, LLC**

410-D Keystone Drive, 15086 Warrendale, PA 15086 - Phone: +1 724 742 0030

customersupport.usa@we-ef.com - <https://we-ef.com/us>

Subject to technical changes and errors. - Generated on 03/10/2025

139-1913

**we-ef**

**FLC230 LED COLOR CHANGER**

**DMX Booster Box**

---

Description	Part ID
DMX Booster Box	400-0474

---



---

**DMX Termination Plug**

---

Description	Part ID
DMX Termination Plug	400-0475

---



---

**WE-EF LIGHTING USA, LLC**

410-D Keystone Drive, 15086 Warrendale, PA 15086 - Phone: +1 724 742 0030  
customersupport.usa@we-ef.com - <https://we-ef.com/us>  
Subject to technical changes and errors. - Generated on 03/10/2025

139-1913

**we-ef**

**FLC230 LED COLOR CHANGER**

**DMX Plug and Socket**

---

Description	Part ID
DMX Plug and Socket	400-0479

---



---

**DMX Combination Cable**

---

Description	Part ID
DMX Combination Cable	400-0480

---



---

**WE-EF LIGHTING USA, LLC**

410-D Keystone Drive, 15086 Warrendale, PA 15086 - Phone: +1 724 742 0030  
customersupport.usa@we-ef.com - <https://we-ef.com/us>  
Subject to technical changes and errors. - Generated on 03/10/2025

**FLC230 LED COLOR CHANGER**

**DMX Wireless Repeater**

---

Description	Part ID
DMX Wireless Repeater	400-0477

---



---

**DMX Wireless Transceiver**

---

Description	Part ID
DMX Wireless Transceiver	400-0476

---



---

**WE-EF LIGHTING USA, LLC**

410-D Keystone Drive, 15086 Warrendale, PA 15086 - Phone: +1 724 742 0030  
customersupport.usa@we-ef.com - <https://we-ef.com/us>  
Subject to technical changes and errors. - Generated on 03/10/2025

**FLC230 LED COLOR CHANGER**

**DMX Controller (smart) - RDM ready**

---

Description	Part ID
DMX Controller (smart) - RDM ready	400-0472

---



**WE-EF LIGHTING USA, LLC**

410-D Keystone Drive, 15086 Warrendale, PA 15086 - Phone: +1 724 742 0030  
customersupport.usa@we-ef.com - <https://we-ef.com/us>  
Subject to technical changes and errors. - Generated on 03/10/2025