



Beschreibung

RGBW/RGBA Farbwechsler. IP66, SKI. SKII auf Anfrage. IK07. Korrosionsbeständiger Aluminiumguss. PCS beschichtete Edelstahlschrauben. 5CE Korrosionsschutz. CCG® Controlled Compression Gasket Silikondichtung. Sicherheitsglas. Eine Kabelverschraubung, eine zweite Kabelverschraubung zur Durchverdrahtung als Variante erhältlich. Eingebaute elektronische Betriebsgeräte, thermisch getrennt. CAD-optimierte OLC® One LED Concept Technik zur Lichtlenkung und Entblendung. Eingebaute LED Platine. DMX Schnittstelle. M20 Kabelverschraubung für Netz- und DMX-Kabel vorgesehen, WE-EF empfiehlt ein Kombikabel für DMX & Power "Power PUR-SR 3x1,5 + DMX".

Gewicht	7.70 kg
Lichtverteilung	symmetrisch mediumstrahlend [M]
Lichtquelle	LED-12/48W - RGBW/4K
CRI	20/80
Netz	EVG
LEDs	12
Bemessungsleistung	50 W

Nominal Lichtstrom (lm)

LED Lumen	340
Total Lumen	4080
Tj	85

Bemessungslichtstrom (lm)

LED Lumen	267.1
Total Lumen	3205
Ta	25

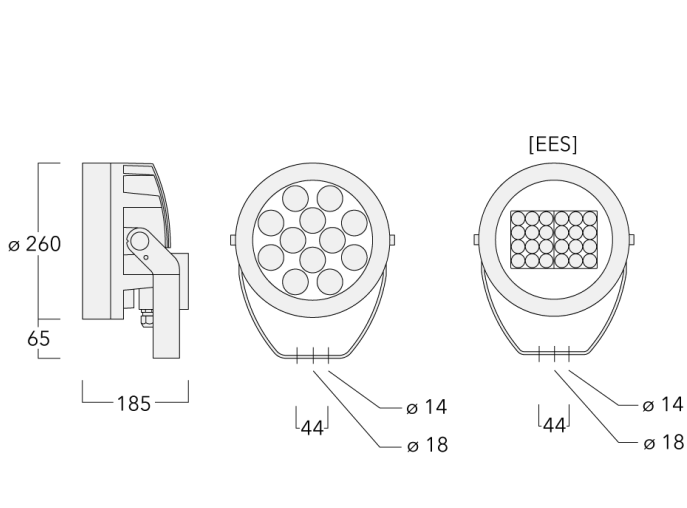

Spezifikationen

Materialbeschreibung

Gehäuse	Korrosionsbeständiger Aluminiumguss
Abdeckung	Sicherheitsglasscheibe
Farben	<ul style="list-style-type: none"> RAL9004 Signalschwarz RAL9006 Weißaluminium RAL9007 Graualuminium RAL7016 Anthrazitgrau RAL9016 Verkehrsweiß
Dichtung	CCG® Silikondichtung
Schrauben	PCS beschichtete Edelstahlschrauben
Schutzart	IP66
Schlagfestigkeit	IK07
Korrosionsbeständigkeit	5CE
Windangriffsfläche	0.054 m ²

Elektrische Beschreibung

Netz	220-240V / 50-60 Hz
Netzgerät / Vorschaltgerät	DMX
Leistungsfaktor	> 0.9
Überspannungsschutz	1/2 kV (optional SP10)

WE-EF LEUCHTEN GmbH

Töpinger Straße 16, 29646 Bispingen, Germany - Tel: +49 5194 909-0
 info.germany@we-ef.com - <https://we-ef.com/de>

Technische Änderungen und Irrtümer vorbehalten. - Erstellt am 10.03.2025

139-1913

FLC230-CC LED

we-ef

Weitere Informationen

Lebensdauer Ta=25° L90B10 > 90000h

Energieeffizienzklasse G (Lichtquelle)

WE-EF LEUCHTEN GmbH

Töpinger Straße 16, 29646 Bispingen, Germany - Tel: +49 5194 909-0

info.germany@we-ef.com - <https://we-ef.com/de>

Technische Änderungen und Irrtümer vorbehalten. - Erstellt am 10.03.2025

Steuerung

Eco Step Dim® Basic

Beschreibung	Artikelnummer
Eco Step Dim® Basic LED	430-0001

Eco Step Dim® Advanced

Beschreibung	Artikelnummer
Eco Step Dim® Advanced LED	430-0002

DMX Controller

Beschreibung	Artikelnummer
DMX Controller	400-0469

DMX Controller (smart)

Beschreibung	Artikelnummer	Weitere Informationen
DMX Controller (smart)	400-0470	IP20. The Touch Panel is an intuitive and easy-to-use keypad or one DMX universe. It can store up to 36 scenes; alternatively, via



DMX Controller - RDM ready

Beschreibung	Artikelnummer
DMX Controller - RDM ready	400-0471

**DMX Splitter**

Beschreibung	Artikelnummer
DMX Splitter	400-0473



139-1913

FLC230-CC LED

we-ef

DMX Booster Box

Beschreibung	Artikelnummer
DMX Booster Box	400-0474



DMX Motion Sensor

Beschreibung	Artikelnummer
DMX Motion Sensor	400-0478



WE-EF LEUCHTEN GmbH

Töpinger Straße 16, 29646 Bispingen, Germany - Tel: +49 5194 909-0

info.germany@we-ef.com - <https://we-ef.com/de>

Technische Änderungen und Irrtümer vorbehalten. - Erstellt am 10.03.2025

DMX Termination Plug

Beschreibung	Artikelnummer
DMX Termination Plug	400-0475

**DMX Plug and Socket**

Beschreibung	Artikelnummer
DMX Plug and Socket	400-0479



DMX Combination Cable

Beschreibung	Artikelnummer
DMX Combination Cable	400-0480

**DMX Wireless Repeater**

Beschreibung	Artikelnummer
DMX Wireless Repeater	400-0477



DMX Wireless Transceiver

Beschreibung	Artikelnummer
DMX Wireless Transceiver	400-0476

**DMX Controller (smart) - RDM ready**

Beschreibung	Artikelnummer
DMX Controller (smart) - RDM ready	400-0472

**R2C Ready to Connect**

Beschreibung	Artikelnummer
R2C Ready to Connect (oben)	430-0019

WE-EF LEUCHTEN GmbH

Töpinger Straße 16, 29646 Bispingen, Germany - Tel: +49 5194 909-0

info.germany@we-ef.com - <https://we-ef.com/de>

Technische Änderungen und Irrtümer vorbehalten. - Erstellt am 10.03.2025

139-1913

FLC230-CC LED

we-ef

DMX Wireless Antenna

Beschreibung	Artikelnummer
Antenne RF 5dB	430-0036
Antenne RF1.8 dB	430-0018

WE-EF LEUCHTEN GmbH

Töpinger Straße 16, 29646 Bispingen, Germany - Tel: +49 5194 909-0

info.germany@we-ef.com - <https://we-ef.com/de>

Technische Änderungen und Irrtümer vorbehalten. - Erstellt am 10.03.2025

Montagezubehör

Mastaufsatztraverse TA

Beschreibung	Artikelnummer	A	C1	D × L1	Gewicht (kg)	D × S
TA1 Mastaufsatztraverse, einfach (Ø 108 x 200)	147-0096		130	108 x 200	7.50	108 x 200

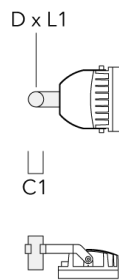

TA2 Mastaufsatztraverse, zweifach (Ø 108 x 200)	147-0097		130	108 x 200	7.50	108 x 200
---	----------	--	-----	-----------	------	-----------

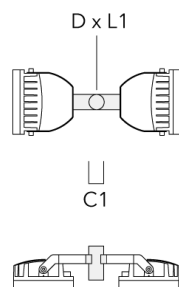

Beschreibung	Artikelnummer	A	C1	D x L1	Gewicht (kg)	D x S
TA2-L Mastaufsatztraverse, zweifach (Ø 108 x 200)	147-0148	±90°	420	108 x 200	20.20	108 x 200

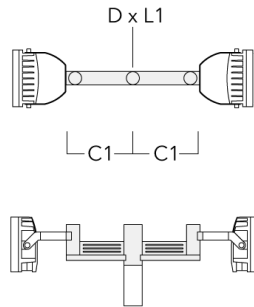

TA2-L Mastaufsatztraverse, zweifach (Ø 76 x 200)	147-0105	±90°	420	76 x 200	16.10	76 x 200
---	----------	------	-----	----------	-------	----------

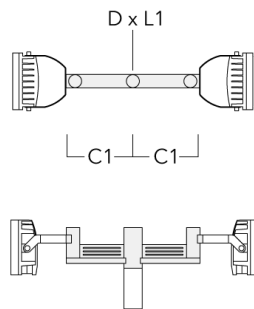

Beschreibung	Artikelnummer	A	C1	D × L1	Gewicht (kg)	D × S
TA3 Mastaufsatztraverse, dreifach (Ø 89 x 200)	147-0025	±90°	650	89 x 200	17.90	89 x 200



TA3 Mastaufsatztraverse, dreifach (Ø 108 x 200)	147-0098	±90°	650	108 x 200	24.20	108 x 200
---	----------	------	-----	-----------	-------	-----------



FLC230-CC LED

Beschreibung	Artikelnummer	A	C1	D x L1	Gewicht (kg)	D x S
TA4 Mastaufsatztraverse, vierfach (Ø 89 x 200)	147-0099	±90°	650	89 x 200	20.80	89 x 200

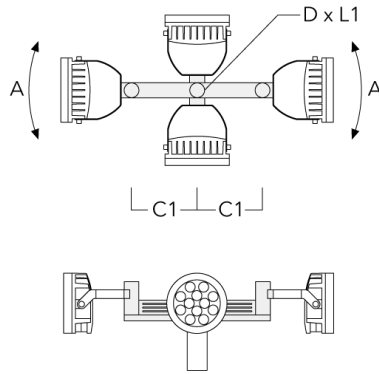

TA4 Mastaufsatztraverse, vierfach (Ø 108 x 200)	147-0100	±90°	650	108 x 200	24.20	108 x 200
---	----------	------	-----	-----------	-------	-----------

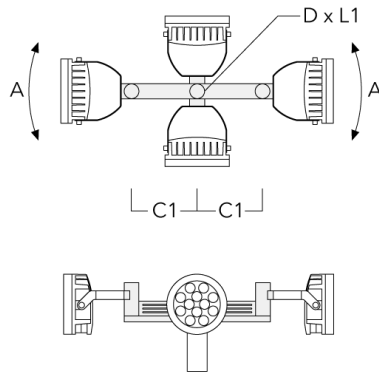

FLC230-CC LED

Beschreibung	Artikelnummer	A	C1	D × L1	Gewicht (kg)	D × S
TA2 Mastaufsatztraverse, zweifach (Ø 76 x 200)	147-0024		130	76 x 200	1.90	76 x 200

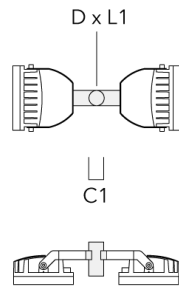

TA1 Mastaufsatztraverse, einfach* (Ø 76 x 200)	147-0023		130	76 x 200	1.50	76 x 200
--	----------	--	-----	----------	------	----------



Mastschelle TS

Beschreibung	Artikelnummer	D1	Gewicht (kg)	D
TS1-2/M12 Mastschelle, einfach (Ø 102-114)	147-0526	102-114	1.50	102-114

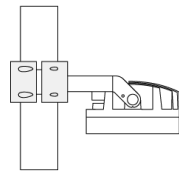
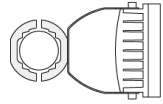

D1

TS1-2/M12 Mastschelle, einfach (Ø 114-133)	147-0544	114-133	1.70	114-133
--	----------	---------	------	---------

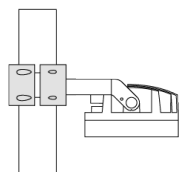
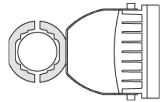

D1

Beschreibung	Artikelnummer	D1	Gewicht (kg)	D
TS1-2/M12 Mastschelle, einfach (Ø 76-89)	147-0543	76-89	1.40	76-89

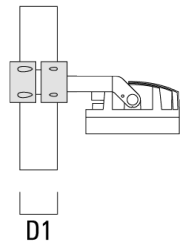
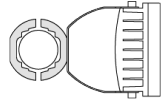

TS2-2/M12 Mastschelle, zweifach (Ø 76-89)	147-0545	76-89	1.40	76-89
---	----------	-------	------	-------

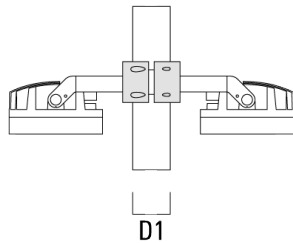
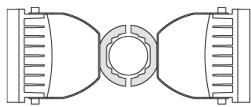

Beschreibung	Artikelnummer	D1	Gewicht (kg)	D
TS2-2/M12 Mastchelle, zweifach (Ø 114-133)	147-0546	114-133	1.60	114-133



TS2-2/M12 Mastchelle, zweifach (Ø 102-114)	147-0527	102-114	1.50	102-114
--	----------	---------	------	---------



Erdstück

Beschreibung	Artikelnummer	D1	D2	D3	D4	H1	H2	M1	Gewicht (kg)
Erdstück ESV4	300-0461	145	130	102	108	400	350	8	7.05

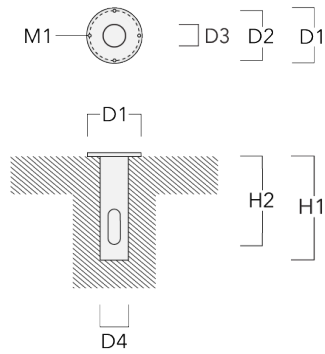

Mastschelle PC

Beschreibung	Artikelnummer	D1	Gewicht (kg)
PC2 76-89/60 Mastschelle, zweifach (Ø 76-89)	139-2703	76-89	1.00

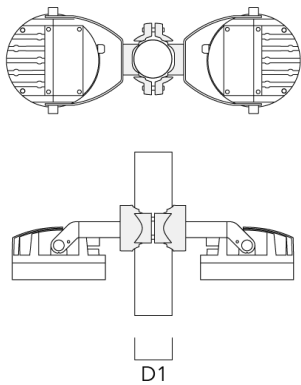

Beschreibung	Artikelnummer	D1	Gewicht (kg)
PC1 76-89/60 Mastschelle, einfach (Ø 76-89)	139-2702	76-89	1.00

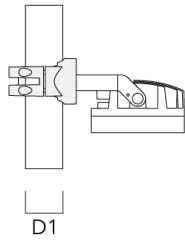
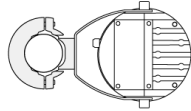

PC2 102-114/60 Mastschelle, zweifach (Ø 102-114)	139-2707	102-114	1.20
--	----------	---------	------



Beschreibung	Artikelnummer	D1	Gewicht (kg)
PC1 102-114/60 Mastschelle, einfach (Ø 102-114)	139-2706	102-114	1.20

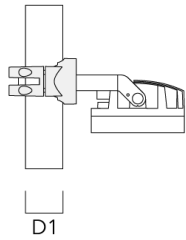
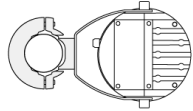

PC2 114-133/60 Mastschelle, zweifach (Ø 114-133)	139-2709	114-133	1.40
---	----------	---------	------

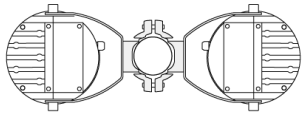

Beschreibung	Artikelnummer	D1	Gewicht (kg)
PC1 114-133/60 Mastshell, einfach (Ø 114-133)	139-2708	114-133	1.40

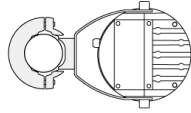

PC2 82-109/60 Mastshell, zweifach (Ø 82-109)	139-2705	82-109	1.10
---	----------	--------	------



139-1913

FLC230-CC LED

we-ef

Beschreibung	Artikelnummer	D1	Gewicht (kg)
PC1 82-109/60 Mastschelle, einfach (Ø 82-109)	139-2704	82-109	1.10

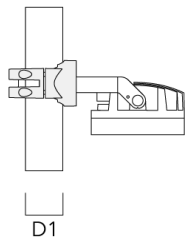

WE-EF LEUCHTEN GmbH

Töpinger Straße 16, 29646 Bispingen, Germany - Tel: +49 5194 909-0

info.germany@we-ef.com - <https://we-ef.com/de>

Technische Änderungen und Irrtümer vorbehalten. - Erstellt am 10.03.2025

Optisches Zubehör

Seitenblende

Beschreibung	Artikelnummer	A	C1
Seitenblende ES	139-1852	159	266

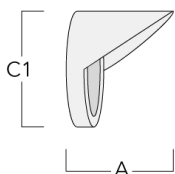

Abblendtubus

Beschreibung	Artikelnummer	A	C1
Abblendtubus ET	139-1853	160	266

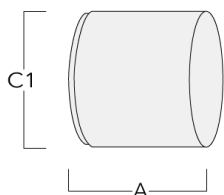

Streulinse bandförmig

Beschreibung	Artikelnummer	C1
IO-180-FLC230-LED	139-1849	199

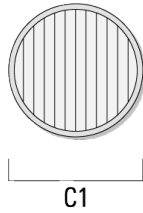
**Streulinse allseitig**

Beschreibung	Artikelnummer	C1
IO-360-FLC230-LED	139-1850	199

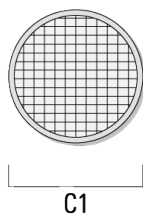

139-1913

FLC230-CC LED

we-ef

Wallwash Linse

Beschreibung	Artikelnummer	C1
IO-20-FLC230-LED	139-1848	199

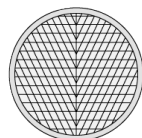

C1