



### Beschreibung

IP66, SKI. SKII auf Anfrage. IK07. Korrosionsbeständiger Aluminiumguss. PCS beschichtete Edelstahlschrauben. 5CE Korrosionsschutz. CCG® Controlled Compression Gasket Silikondichtung. Sicherheitsglas. Eine Kabelverschraubung, eine zweite Kabelverschraubung zur Durchverdrahtung auf Anfrage. Eingebaute elektronische Betriebsgeräte, thermisch getrennt. CAD-optimierte OLC® One LED Concept Technik zur Lichtlenkung und Entblendung. Eingebaute LED Platine. 1-10V, DALI Schnittstelle oder Eco Step Dim® auf Anfrage. Maximal ein internes Zubehörteil möglich. Variante mit 2200 K bis max. 1050 mA erhältlich, nicht für [EES] Version. Bei Bestellung bitte angeben.

Gewicht	7.60 kg
Lichtverteilung	bandförmig extrem engstrahlend [EE]
Lichtquelle	LED-12/24W / 700 mA - 3000 K
CRI	80
Netz	EVG
LEDs	12
Bemessungsleistung	27 W
<b>Nominal Lichtstrom (lm)</b>	
LED Lumen	290
Total Lumen	3480
Tj	85
<b>Bemessungslichtstrom (lm)</b>	
LED Lumen	247.8
Total Lumen	2973.9
Ta	25

### WE-EF Switzerland AG

Himmelrichstrasse 6, 6003 Luzern - Tel: +41 41 210 49 95

info.switzerland@we-ef.com - [https://we-ef.com/ch\\_de](https://we-ef.com/ch_de)

Technische Änderungen und Irrtümer vorbehalten. - Erstellt am 23.11.2024

## FLC230 LED



## Spezifikationen

## Materialbeschreibung

Gehäuse	Korrosionsbeständiger Aluminiumguss
Abdeckung	Sicherheitsglasscheibe
Farben	<ul style="list-style-type: none"> <li><span style="display: inline-block; width: 15px; height: 15px; background-color: black; margin-right: 5px;"></span> RAL9004 Signalschwarz</li> <li><span style="display: inline-block; width: 15px; height: 15px; background-color: gray; margin-right: 5px;"></span> RAL9007 Graualuminium</li> <li><span style="display: inline-block; width: 15px; height: 15px; background-color: darkgray; margin-right: 5px;"></span> RAL7016 Anthrazitgrau</li> <li><span style="display: inline-block; width: 15px; height: 15px; background-color: lightgray; margin-right: 5px;"></span> RAL9016 Verkehrsweiß</li> </ul>
Dichtung	CCG® Silikondichtung
Schrauben	PCS beschichtete Edelstahlschrauben
Schutzart	IP66
Schlagfestigkeit	IK07
Korrosionsbeständigkeit	5CE
Windangriffsfläche	0.054 m <sup>2</sup>

## Elektrische Beschreibung

Netz	220-240V / 50-60 Hz
Netzgerät / Vorschaltgerät	Standard. Variante mit DALI erhältlich, bei Bestellung bitte angeben.
Leistungsfaktor	> 0.9
Überspannungsschutz	6/6 kV (optional SP10)

## WE-EF Switzerland AG

Himmelrichstrasse 6, 6003 Luzern - Tel: +41 41 210 49 95  
 info.switzerland@we-ef.com - [https://we-ef.com/ch\\_de](https://we-ef.com/ch_de)  
 Technische Änderungen und Irrtümer vorbehalten. - Erstellt am 23.11.2024

**139-1834+139-1849**

**we-ef**

**FLC230 LED**

### **Weitere Informationen**

---

Lebensdauer                    Ta=25° L90B10 > 90000h

Energieeffizienzklasse    C-D (Lichtquelle)

---

**WE-EF Switzerland AG**

Himmelrichstrasse 6, 6003 Luzern - Tel: +41 41 210 49 95

info.switzerland@we-ef.com - [https://we-ef.com/ch\\_de](https://we-ef.com/ch_de)

Technische Änderungen und Irrtümer vorbehalten. - Erstellt am 23.11.2024

## FLC230 LED

## Montagezubehör

## Montagesockel EM

Beschreibung	Artikelnummer	D1	D2	H1	M1	Gewicht (kg)
EM1-M16 AL	270-9038	160	130	203	9	2

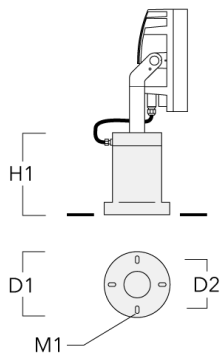

## Mastaufsatztraverse TA

Beschreibung	Artikelnummer	A	C1	D x L1	Gewicht (kg)	D x S
TA1 Mastaufsatztraverse, einfach (Ø 108 x 200)	147-0096		130	108 x 200	7.50	108 x 200

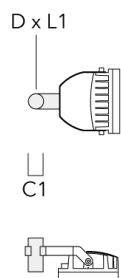

## WE-EF Switzerland AG

Himmelrichstrasse 6, 6003 Luzern - Tel: +41 41 210 49 95

info.switzerland@we-ef.com - [https://we-ef.com/ch\\_de](https://we-ef.com/ch_de)

Technische Änderungen und Irrtümer vorbehalten. - Erstellt am 23.11.2024

**FLC230 LED**

Beschreibung	Artikelnummer	A	C1	D x L1	Gewicht (kg)	D x S
TA2 Mastaufsatztraverse, zweifach (Ø 108 x 200)	147-0097		130	108 x 200	7.50	108 x 200

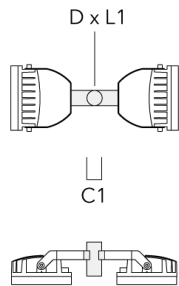

TA2-L Mastaufsatztraverse, zweifach (Ø 108 x 200)	147-0148	±90°	420	108 x 200	20.20	108 x 200
---	----------	------	-----	-----------	-------	-----------

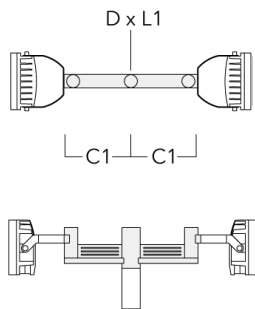

**FLC230 LED**

Beschreibung	Artikelnummer	A	C1	D x L1	Gewicht (kg)	D x S
TA2-L Mastaufsatztraverse, zweifach (Ø 76 x 200)	147-0105	±90°	420	76 x 200	16.10	76 x 200



TA3 Mastaufsatztraverse, dreifach (Ø 89 x 200)	147-0025	±90°	650	89 x 200	17.90	89 x 200
--	----------	------	-----	----------	-------	----------



**FLC230 LED**

Beschreibung	Artikelnummer	A	C1	D x L1	Gewicht (kg)	D x S
TA3 Mastaufsatztraverse, dreifach (Ø 108 x 200)	147-0098	±90°	650	108 x 200	24.20	108 x 200



TA4 Mastaufsatztraverse, vierfach (Ø 89 x 200)	147-0099	±90°	650	89 x 200	20.80	89 x 200
--	----------	------	-----	----------	-------	----------



**FLC230 LED**

Beschreibung	Artikelnummer	A	C1	D x L1	Gewicht (kg)	D x S
TA4 Mastaufsatztraverse, vierfach (Ø 108 x 200)	147-0100	±90°	650	108 x 200	24.20	108 x 200

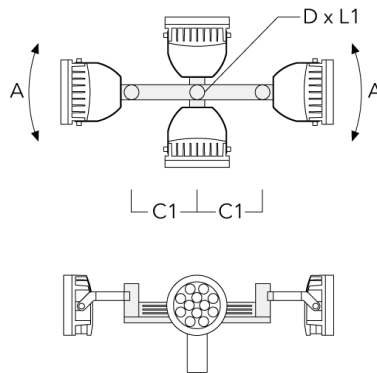

TA2 Mastaufsatztraverse, zweifach (Ø 76 x 200)	147-0024		130	76 x 200	1.90	76 x 200
--	----------	--	-----	----------	------	----------

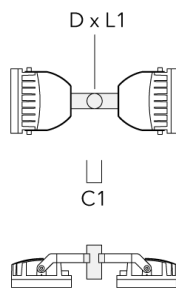



## FLC230 LED

Beschreibung	Artikelnummer	A	C1	D × L1	Gewicht (kg)	D × S
TA1 Mastaufsatztraverse, einfach* (Ø 76 x 200)	147-0023		130	76 x 200	1.50	76 x 200



## Mastschelle TS

Beschreibung	Artikelnummer	D1	Gewicht (kg)	D
TS1-2/M12 Mastschelle, einfach (Ø 102-114)	147-0526	102-114	1.50	102-114

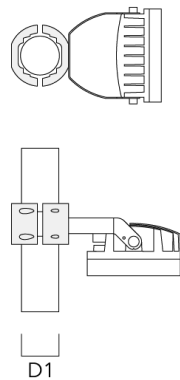

## WE-EF Switzerland AG

Himmelrichstrasse 6, 6003 Luzern - Tel: +41 41 210 49 95

info.switzerland@we-ef.com - [https://we-ef.com/ch\\_de](https://we-ef.com/ch_de)

Technische Änderungen und Irrtümer vorbehalten. - Erstellt am 23.11.2024

## FLC230 LED

Beschreibung	Artikelnummer	D1	Gewicht (kg)	D
TS1-2/M12 Mastschelle, einfach (Ø 114-133)	147-0544	114-133	1.70	114-133

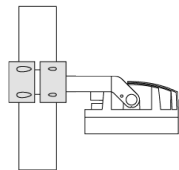
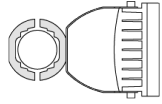

D1

TS1-2/M12 Mastschelle, einfach (Ø 76-89)	147-0543	76-89	1.40	76-89
--	----------	-------	------	-------

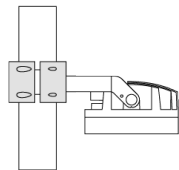
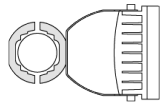

D1

**FLC230 LED**

Beschreibung	Artikelnummer	D1	Gewicht (kg)	D
TS2-2/M12 Mastschelle, zweifach (Ø 76-89)	147-0545	76-89	1.40	76-89



TS2-2/M12 Mastschelle, zweifach (Ø 114-133)	147-0546	114-133	1.60	114-133
---	----------	---------	------	---------



**FLC230 LED**

Beschreibung	Artikelnummer	D1	Gewicht (kg)	D
TS2-2/M12 Mastschelle, zweifach (Ø 102-114)	147-0527	102-114	1.50	102-114

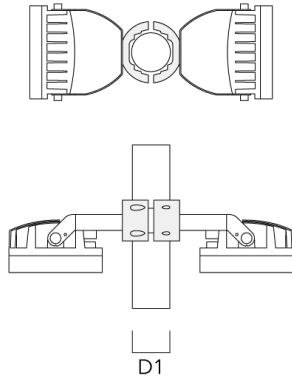

**Erdstück**

Beschreibung	Artikelnummer	D1	D2	D3	D4	H1	H2	M1	Gewicht (kg)
Erdstück ESV4	300-0461	145	130	102	108	400	350	8	7.05



## FLC230 LED

## Mastschelle PC

Beschreibung	Artikelnummer	D1	Gewicht (kg)
PC2 76-89/60 Mastschelle, zweifach (Ø 76-89)	139-2703	76-89	1.00

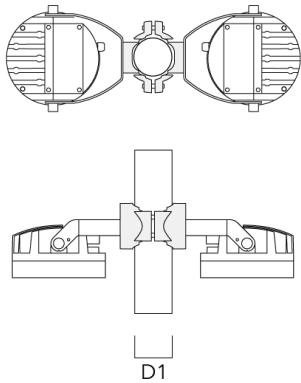

PC1 76-89/60 Mastschelle, einfach (Ø 76-89)	139-2702	76-89	1.00
---	----------	-------	------



## FLC230 LED

Beschreibung	Artikelnummer	D1	Gewicht (kg)
PC2 102-114/60 Mastschelle, zweifach (Ø 102-114)	139-2707	102-114	1.20



PC1 102-114/60 Mastschelle, einfach (Ø 102-114)	139-2706	102-114	1.20
--	----------	---------	------



**FLC230 LED**

Beschreibung	Artikelnummer	D1	Gewicht (kg)
PC2 114-133/60 Mastschelle, zweifach (Ø 114-133)	139-2709	114-133	1.40



PC1 114-133/60 Mastschelle, einfach (Ø 114-133)	139-2708	114-133	1.40
--	----------	---------	------



## FLC230 LED

Beschreibung	Artikelnummer	D1	Gewicht (kg)
PC2 82-109/60 Mastschelle, zweifach (Ø 82-109)	139-2705	82-109	1.10



PC1 82-109/60 Mastschelle, einfach (Ø 82-109)	139-2704	82-109	1.10
--	----------	--------	------





**Steuerung**

**Eco Step Dim® Basic**

Beschreibung	Artikelnummer
Eco Step Dim® Basic LED	430-0001

**Eco Step Dim® Advanced**

Beschreibung	Artikelnummer
Eco Step Dim® Advanced LED	430-0002

**R2C Ready to Connect**

Beschreibung	Artikelnummer
R2C Ready to Connect (oben)	430-0019

**FLC230 LED**

**Optisches Zubehör**

**Streulinse bandförmig**

---

Beschreibung	Artikelnummer	C1
IO-180-FLC230-LED	139-1849	199

---

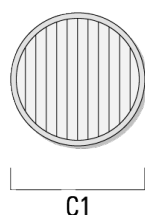

---

**Streulinse allseitig**

---

Beschreibung	Artikelnummer	C1
IO-360-FLC230-LED	139-1850	199

---

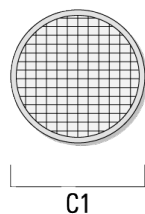

## FLC230 LED

## Wabenblende

Beschreibung	Artikelnummer	C1
IW-FLC230-LED - [E][EE][EES]	139-1851	199

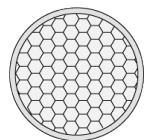

C1

## Seitenblende

Beschreibung	Artikelnummer	A	C1
Seitenblende ES	139-1852	159	266

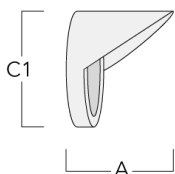

## FLC230 LED

## Abblendtubus

Beschreibung	Artikelnummer	A	C1
Abblendtubus ET	139-1853	160	266

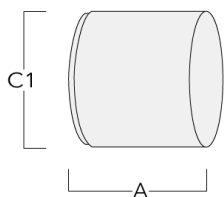

## Wallwash Linse

Beschreibung	Artikelnummer	C1
IO-20-FLC230-LED	139-1848	199

