

139-1964

FLC260 LED

**we-ef**



### Description

IP66. Class I. IK07. Marine-grade, die-cast aluminum alloy. 5CE superior corrosion protection including PCS hardware. Silicone CCG® Controlled Compression Gasket. Safety glass lens. One cable gland, second gland for through wiring on request. CAD-optimized optics for superior illumination and glare control. Integral driver, thermally separated. OLC® One LED Concept. Factory-installed LED circuit board. 0-10V Dimming on request.

A maximum of one internal optical accessory.

Specify product with 7 Digit product code - Finish Color. Accessories, such as mounting, optical, and electrical, must be specified separately.

Example: XXX-XXXX-9004 (Black)  
+ XXX-XXXX (Accessory 1)

|                    |                                |
|--------------------|--------------------------------|
| Weight             | 38.58 lb                       |
| Light distribution | symmetric, wide beam [W]       |
| Light source       | LED-36/155W / 1400 mA - 4000 K |
| CRI                | 80                             |
| Power supply       | electronic gear                |
| LEDs               | 36                             |
| Rated input power  | 172 W                          |

### Nominal Lumen (lm)

|             |       |
|-------------|-------|
| LED Lumen   | 575   |
| Total Lumen | 20700 |
| Tj          | 85    |

### Rated lumens (lm)

|             |         |
|-------------|---------|
| LED Lumen   | 477.5   |
| Total Lumen | 17188.5 |
| Ta          | 25      |

### WE-EF LIGHTING USA, LLC

410-D Keystone Drive, 15086 Warrendale, PA 15086 - Phone: +1 724 742 0030  
customersupport.usa@we-ef.com - <https://we-ef.com/us>  
Subject to technical changes and errors. - Generated on 11/23/2024

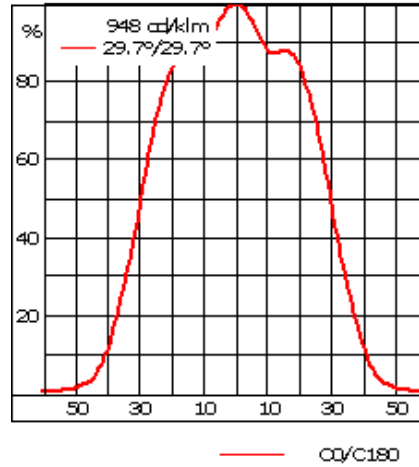
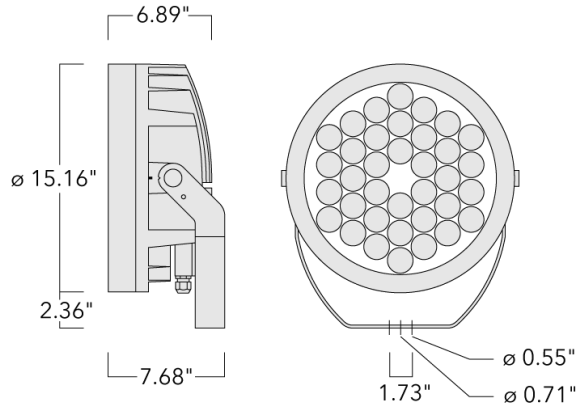

## Specifications

### Material description

|                      |   |
|----------------------|---|
| Body                 | Marine-grade, die-cast aluminium alloy  |
| Lens                 | Safety glass lens   |
| Colors               | <div style="display: flex; flex-direction: column; gap: 5px;"> <div><span style="display: inline-block; width: 15px; height: 15px; background-color: black; margin-right: 5px;"></span> RAL9004 Black</div> <div><span style="display: inline-block; width: 15px; height: 15px; background-color: grey; margin-right: 5px;"></span> RAL9007 Grey Metallic</div> <div><span style="display: inline-block; width: 15px; height: 15px; background-color: white; margin-right: 5px;"></span> RAL9016 White</div> <div><span style="display: inline-block; width: 15px; height: 15px; background-color: darkgrey; margin-right: 5px;"></span> RAL8019 Dark Bronze</div> </div> |
| Gasket               | Silicone CCG® Controlled Compression Gasket   |
| Fasteners            | PCS Polymer Coated Stainless Steel Hardware   |
| Ingress protection   | IP66  |
| Impact resistance    | IK07  |
| Corrosion resistance | 5CE   |
| Windage              | 1.5   |

**WE-EF LIGHTING USA, LLC**

410-D Keystone Drive, 15086 Warrendale, PA 15086 - Phone: +1 724 742 0030  
 customersupport.usa@we-ef.com - <https://we-ef.com/us>  
 Subject to technical changes and errors. - Generated on 11/23/2024

**139-1964**

**FLC260 LED**

**we-ef**

**Electrical description**

---

|                  |   |
|------------------|---|
| Power supply     | Integral [ECG] electronic driver 120V-277V. 0-10V dimmable, to be specified with order. |
| Driver / Ballast | Integral EC electronic converter in thermally-separated compartment                     |
| Power factor     | > 0.9   |
| Surge protection | Integral 10kV Surge Protector   |

---

**Additional information**

---

|          |  |
|----------|--|
| Lifetime | Ta=25°/40° L90B10 > 90000h                                 |
| Listings | ETL, UL-1598, CSA-C22.2#250.0. Suitable for Wet Locations. |

---

**WE-EF LIGHTING USA, LLC**

410-D Keystone Drive, 15086 Warrendale, PA 15086 - Phone: +1 724 742 0030  
customersupport.usa@we-ef.com - <https://we-ef.com/us>  
Subject to technical changes and errors. - Generated on 11/23/2024

139-1964

FLC260 LED

**we-ef**

## Mounting Accessories

### Short post EM

| Description                     | Part ID  | D1  | D2   | H1    | M1    | Weight (lb) |
|---------------------------------|----------|-----|------|-------|-------|-------------|
| EM1-M16 AL - Single Cable Entry | 270-9038 | 6.3 | 5.12 | 7.87" | 0.35" | 4.85 lbs    |



#### WE-EF LIGHTING USA, LLC

410-D Keystone Drive, 15086 Warrendale, PA 15086 - Phone: +1 724 742 0030

customersupport.usa@we-ef.com - <https://we-ef.com/us>

Subject to technical changes and errors. - Generated on 11/23/2024

**FLC260 LED**

**Planted root**

| Description       | Part ID  | D1   | D2   | D3   | D4   | H1    | H2    | M1  | Weight (lb) |
|-------------------|----------|------|------|------|------|-------|-------|-----|-------------|
| Planted root ESV4 | 300-0461 | 5.71 | 5.12 | 4.01 | 4.25 | 15.75 | 13.78 | .31 | 15.54       |

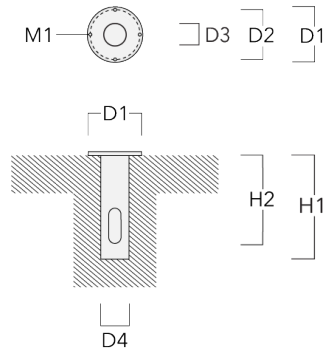

**Floodlight mounting bracket TA**

| Description                            | Part ID  | A | C1   | D × L1 | L    | Weight (lb) | D × S    |
|--|----------|---|------|--------|------|-------------|----------|
| TA2 Mounting bracket, double (Ø 3 x 8) | 147-0024 |   | 5.12 | 3 x 8  | 2.99 | 4.2 lbs     | 76 x 200 |

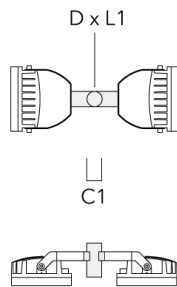

**WE-EF LIGHTING USA, LLC**

410-D Keystone Drive, 15086 Warrendale, PA 15086 - Phone: +1 724 742 0030  
 customersupport.usa@we-ef.com - <https://we-ef.com/us>  
 Subject to technical changes and errors. - Generated on 11/23/2024

**FLC260 LED**

| Description                              | Part ID  | A    | C1    | D x L1 | L    | Weight (lb) | D x S    |
|--|----------|------|-------|--------|------|-------------|----------|
| TA2-L Mounting bracket, double (Ø 3 x 8) | 147-0105 | ±90° | 16.54 | 3 x 8  | 2.99 | 35.49       | 76 x 200 |

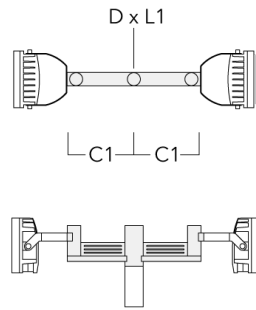

|   |          |      |       |          |     |       |          |
|---|----------|------|-------|----------|-----|-------|----------|
| TA3 Mounting bracket, triple (Ø 3.50 x 8) | 147-0025 | ±90° | 25.59 | 3.50 x 8 | 3.5 | 39.46 | 89 x 200 |
|---|----------|------|-------|----------|-----|-------|----------|

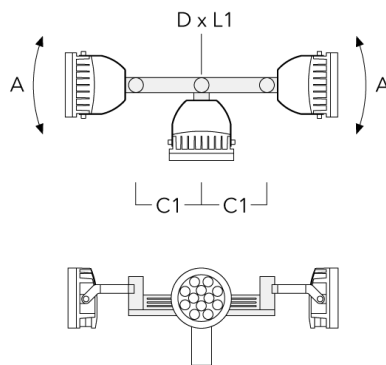

**WE-EF LIGHTING USA, LLC**

410-D Keystone Drive, 15086 Warrendale, PA 15086 - Phone: +1 724 742 0030  
 customersupport.usa@we-ef.com - <https://we-ef.com/us>  
 Subject to technical changes and errors. - Generated on 11/23/2024

**FLC260 LED**

| Description                             | Part ID  | A    | C1    | D x L1   | L | Weight (lb) | D x S    |
|---|----------|------|-------|----------|---|-------------|----------|
| TA4 Mounting bracket, quad (Ø 3.50 x 8) | 147-0099 | ±90° | 25.59 | 3.50 x 8 |   | 45.86 lbs   | 89 x 200 |

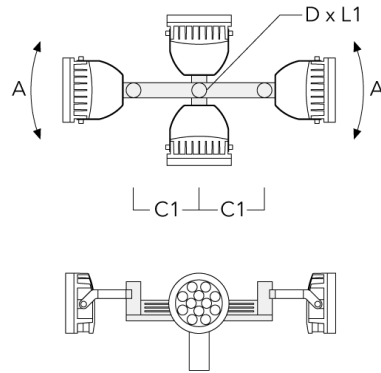

|   |          |  |      |          |      |       |           |
|---|----------|--|------|----------|------|-------|-----------|
| TA1 Mounting bracket, single (Ø 4.25 x 8) | 147-0096 |  | 5.12 | 4.25 x 8 | 4.25 | 16.53 | 108 x 200 |
|---|----------|--|------|----------|------|-------|-----------|

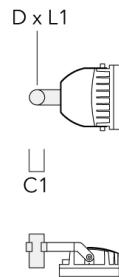

**WE-EF LIGHTING USA, LLC**

410-D Keystone Drive, 15086 Warrendale, PA 15086 - Phone: +1 724 742 0030  
 customersupport.usa@we-ef.com - <https://we-ef.com/us>  
 Subject to technical changes and errors. - Generated on 11/23/2024

**FLC260 LED**

| Description                               | Part ID  | A    | C1     | D x L1   | L | Weight (lb) | D x S     |
|---|----------|------|--------|----------|---|-------------|-----------|
| TA3 Mounting bracket, triple (Ø 4.25 x 8) | 147-0098 | ±90° | 25.59" | 4.25 x 8 |   | 53.35 lbs   | 108 x 200 |

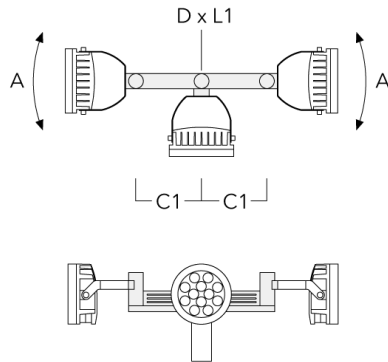

**Pole clamp TS**

| Description                                | Part ID  | D1       | Weight (lb) | D       |
|--|----------|----------|-------------|---------|
| TS1-2/M12 Pole clamp, single (Ø 4.0"-4.5") | 147-0526 | 4.0-4.50 | 3.53        | 102-114 |

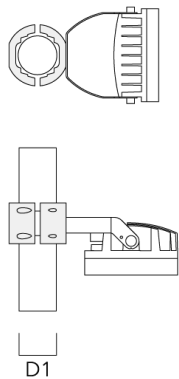

**WE-EF LIGHTING USA, LLC**

410-D Keystone Drive, 15086 Warrendale, PA 15086 - Phone: +1 724 742 0030  
 customersupport.usa@we-ef.com - <https://we-ef.com/us>  
 Subject to technical changes and errors. - Generated on 11/23/2024



**FLC260 LED**

---

| Description                              | Part ID  | D1       | Weight (lb) | D     |
|--|----------|----------|-------------|-------|
| TS1-2/M12 Pole clamp, single (Ø 3"-3.5") | 147-0543 | 3.0-3.50 | 3.31        | 76-89 |

---

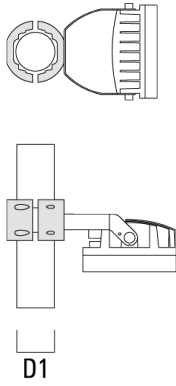

---

|   |          |          |      |         |
|---|----------|----------|------|---------|
| TS1-2/M16 Pole clamp, single (Ø 4.5"-5.25") | 147-0544 | 4.5-5.25 | 1.70 | 114-133 |
|---|----------|----------|------|---------|

---

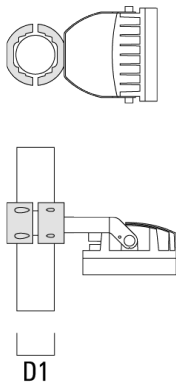

**WE-EF LIGHTING USA, LLC**

410-D Keystone Drive, 15086 Warrendale, PA 15086 - Phone: +1 724 742 0030  
customersupport.usa@we-ef.com - <https://we-ef.com/us>  
Subject to technical changes and errors. - Generated on 11/23/2024

---

| Description                              | Part ID  | D1        | Weight (lb) | D     |
|--|----------|-----------|-------------|-------|
| TS2-2/M16 Pole clamp, double (Ø 3"-3.5") | 147-0545 | 3.0"-3.5" | 3.09 lbs    | 76-89 |

---

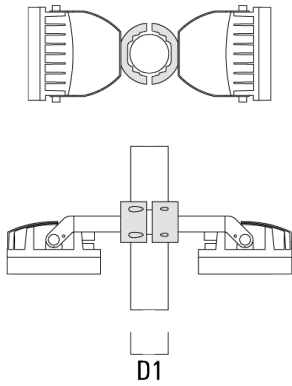

---

|  |          |          |      |         |
|--|----------|----------|------|---------|
| TS2-2/M16 Pole clamp, double (Ø 4.0"-4.5") | 147-0527 | 4.0-4.50 | 3.31 | 102-114 |
|--|----------|----------|------|---------|

---

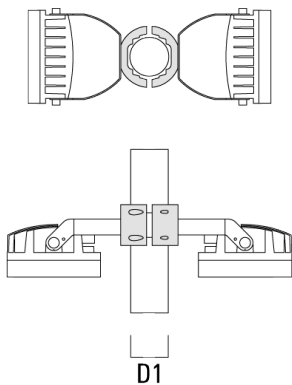

139-1964

**we-ef**

**FLC260 LED**

---

| Description                                 | Part ID  | D1        | Weight (lb) | D       |
|---|----------|-----------|-------------|---------|
| TS2-2/M12 Pole clamp, double (Ø 4.5"-5.25") | 147-0546 | 4.50-5.25 | 3.53        | 114-133 |

---

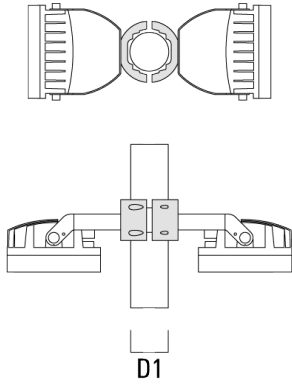

---

**Pole top caps KF**

---

| Description                      | Part ID  | D1   | D × L1   | Weight (lb) | D        |
|----------------------------------|----------|------|----------|-------------|----------|
| KF16-60/M16 Spigot Cap (Ø 2.36") | 310-9120 | 2.36 | 2.36 x 4 | 4.4 lbs     | 60 x 100 |

---



---

**WE-EF LIGHTING USA, LLC**

410-D Keystone Drive, 15086 Warrendale, PA 15086 - Phone: +1 724 742 0030

customersupport.usa@we-ef.com - <https://we-ef.com/us>

Subject to technical changes and errors. - Generated on 11/23/2024

---

| Description                    | Part ID  | D1 | D × L1 | Weight (lb) | D        |
|--------------------------------|----------|----|--------|-------------|----------|
| KF1-76/M16 Spigot Cap (Ø 3.0") | 310-9121 | 3  | 3 x 4  | 1.10 lbs    | 76 x 100 |

---



---

|                                 |          |      |         |          |    |
|---------------------------------|----------|------|---------|----------|----|
| KF16-89/M16 Spigot Cap (Ø 3.5") | 300-0734 | 3.50 | 3.5 x 3 | 1.10 lbs | 89 |
|---------------------------------|----------|------|---------|----------|----|

---



**FLC260 LED**

| Description                       | Part ID  | D1   | D × L1   | Weight (lb) | D   |
|-----------------------------------|----------|------|----------|-------------|-----|
| KF16-108/M16 Spigot Cap (Ø 4.25") | 300-0735 | 4.25 | 4.25 x 3 | 4.4 lbs     | 108 |

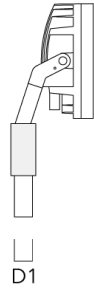

**Wall Mount Bracket WMB**

| Description               | Part ID  | C1    | C2   | D1   | D2   | H1    | M1   | M2   | Weight (lb) |
|---------------------------|----------|-------|------|------|------|-------|------|------|-------------|
| WMB200 Wall mount bracket | 147-6015 | 20.28 | 4.72 | 9.25 | 7.88 | 11.34 | 1.05 | 0.47 | 20.0 lbs    |

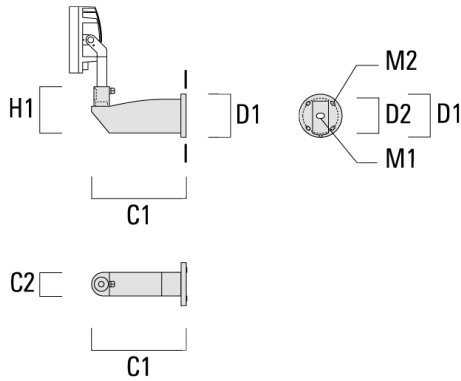

**WE-EF LIGHTING USA, LLC**

410-D Keystone Drive, 15086 Warrendale, PA 15086 - Phone: +1 724 742 0030

customersupport.usa@we-ef.com - <https://we-ef.com/us>

Subject to technical changes and errors. - Generated on 11/23/2024

139-1964

FLC260 LED

**we-ef**

**Surface Mount Canopy SMC**

---

| Description | Part ID  | D1    | D2   | Weight (lb) |
|-------------|----------|-------|------|-------------|
| SMC-200     | 147-6915 | 10.83 | 9.25 | 15.4 lbs    |

---

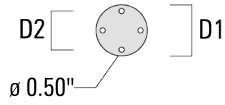

**WE-EF LIGHTING USA, LLC**

410-D Keystone Drive, 15086 Warrendale, PA 15086 - Phone: +1 724 742 0030  
customersupport.usa@we-ef.com - <https://we-ef.com/us>

Subject to technical changes and errors. - Generated on 11/23/2024

**Junction box**

| Description                            | Part ID  | Additional information   | A    | B    | C1   | Weight (lb) |
|--|----------|--|------|------|------|-------------|
| Junction box JB20 - Cable side entries | 310-9013 | Junction boxes are made from marine-grade, die-cast aluminium alloy. IK10. IP66. For side entries and suitable to be used with cable glands. | 7.09 | 5.63 | 2.01 | 2.25        |

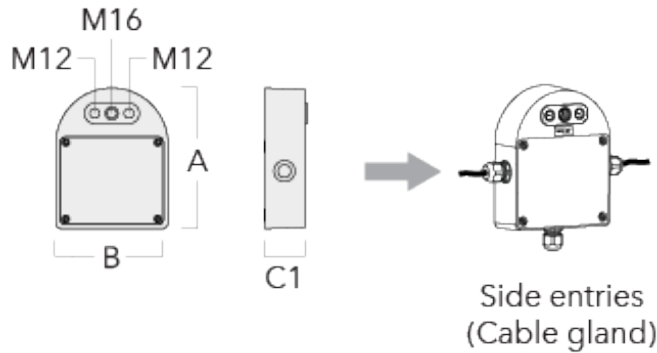

|  |          |  |      |      |      |      |
|--|----------|--|------|------|------|------|
| Junction box JB20 - Conduit side entries | 310-9014 | Junction boxes are made from marine-grade, die-cast aluminium alloy. IK10. IP66. For side entries and suitable to be used with conduits. | 7.09 | 5.63 | 2.01 | 2.25 |
|--|----------|--|------|------|------|------|

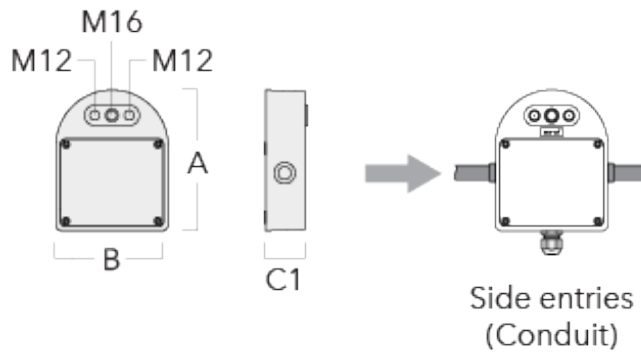

**Pole clamp PC**

---

| Description                                 | Part ID  | D1       | Weight (lb) |
|---|----------|----------|-------------|
| PC2 76-89/60 Pole clamp, double (Ø 3"-3.5") | 139-2703 | 3.0-3.50 | 2.20        |

---

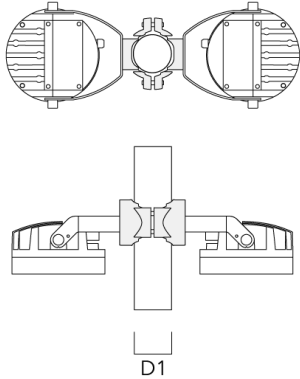

---

|   |          |          |      |
|---|----------|----------|------|
| PC1 76-89/60 Pole clamp, single (Ø 3"-3.5") | 139-2702 | 3.0-3.50 | 2.20 |
|---|----------|----------|------|

---

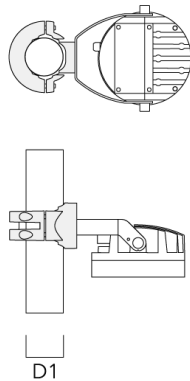



**FLC260 LED**

---

| Description                                      | Part ID  | D1       | Weight (lb) |
|--|----------|----------|-------------|
| PC2 102-114/60 Pole clamp, double<br>(Ø 4"-4.5") | 139-2707 | 4.0-4.50 | 2.65        |

---

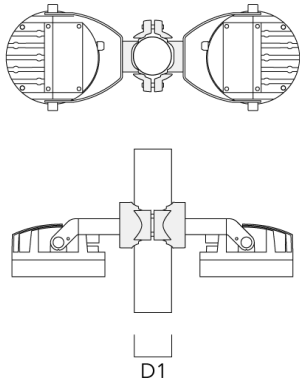

---

|  |          |          |      |
|--|----------|----------|------|
| PC1 102-114/60 Pole clamp, single<br>(Ø 4"-4,5") | 139-2706 | 4.0-4.50 | 2.65 |
|--|----------|----------|------|

---



**WE-EF LIGHTING USA, LLC**

410-D Keystone Drive, 15086 Warrendale, PA 15086 - Phone: +1 724 742 0030  
customersupport.usa@we-ef.com - <https://we-ef.com/us>  
Subject to technical changes and errors. - Generated on 11/23/2024

**FLC260 LED**

| Description   | Part ID  | D1       | Weight (lb) |
|---|----------|----------|-------------|
| PC2 114-133/60 Pole clamp, double<br>(Ø 4.5"-5.25") | 139-2709 | 4.5-5.25 | 3.10        |

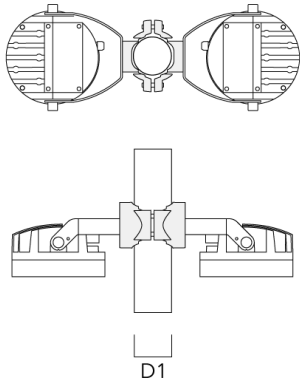

|   |          |          |      |
|---|----------|----------|------|
| PC1 114-133/60 Pole clamp, single<br>(Ø 4.5"-5.25") | 139-2708 | 4.5-5.25 | 3.10 |
|---|----------|----------|------|

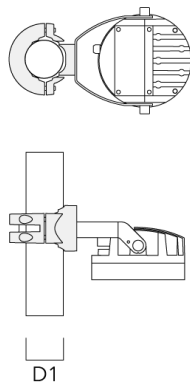

**WE-EF LIGHTING USA, LLC**

410-D Keystone Drive, 15086 Warrendale, PA 15086 - Phone: +1 724 742 0030  
 customersupport.usa@we-ef.com - <https://we-ef.com/us>  
 Subject to technical changes and errors. - Generated on 11/23/2024

**139-1964**

**FLC260 LED**

**we-ef**

---

| Description   | Part ID  | D1        | Weight (lb) |
|---|----------|-----------|-------------|
| PC2 82-109/60 Pole clamp, double<br>(Ø 3.25"-4.25") | 139-2705 | 3.20-4.30 | 2.40        |

---



**WE-EF LIGHTING USA, LLC**

410-D Keystone Drive, 15086 Warrendale, PA 15086 - Phone: +1 724 742 0030  
customersupport.usa@we-ef.com - <https://we-ef.com/us>  
Subject to technical changes and errors. - Generated on 11/23/2024

**139-1964**

**FLC260 LED**

**we-ef**

## Optical Accessories

### Wallwash lens

---

| Description      | Part ID  | C1    |
|------------------|----------|-------|
| IO-20-FLC260-LED | 139-1860 | 13.07 |

---

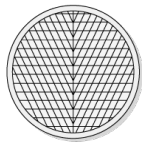

C1

---

#### WE-EF LIGHTING USA, LLC

410-D Keystone Drive, 15086 Warrendale, PA 15086 - Phone: +1 724 742 0030

customersupport.usa@we-ef.com - <https://we-ef.com/us>

Subject to technical changes and errors. - Generated on 11/23/2024

139-1964

FLC260 LED

**we-ef**

**Linear spread lens**

---

| Description       | Part ID  | C1    |
|-------------------|----------|-------|
| IO-180-FLC260-LED | 139-1861 | 13.07 |

---

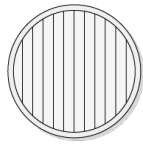

---

**Softening Lens**

---

| Description       | Part ID  | C1    |
|-------------------|----------|-------|
| IO-360-FLC260-LED | 139-1862 | 13.07 |

---

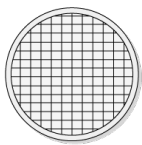

---

**WE-EF LIGHTING USA, LLC**

410-D Keystone Drive, 15086 Warrendale, PA 15086 - Phone: +1 724 742 0030

customersupport.usa@we-ef.com - <https://we-ef.com/us>

Subject to technical changes and errors. - Generated on 11/23/2024

139-1964

FLC260 LED

**we-ef**

### Honeycomb louvre

---

| Description       | Part ID  | C1    |
|-------------------|----------|-------|
| IW-360-FLC260-LED | 139-1863 | 12.76 |

---

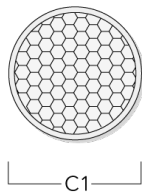

---

### Snoot

---

| Description   | Part ID  | A    | C1    |
|---------------|----------|------|-------|
| ET-FLC260-LED | 139-1865 | 8.74 | 15.47 |

---

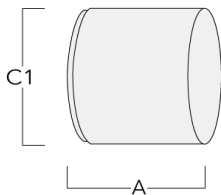

---

#### WE-EF LIGHTING USA, LLC

410-D Keystone Drive, 15086 Warrendale, PA 15086 - Phone: +1 724 742 0030

customersupport.usa@we-ef.com - <https://we-ef.com/us>

Subject to technical changes and errors. - Generated on 11/23/2024

**139-1964**

**FLC260 LED**

**we-ef**

**Glare shield**

---

| Description   | Part ID  | A    | C1    |
|---------------|----------|------|-------|
| ES-FLC260-LED | 139-1864 | 8.74 | 15.47 |

---

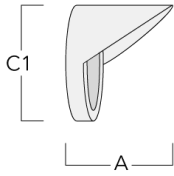

**WE-EF LIGHTING USA, LLC**

410-D Keystone Drive, 15086 Warrendale, PA 15086 - Phone: +1 724 742 0030  
customersupport.usa@we-ef.com - <https://we-ef.com/us>

Subject to technical changes and errors. - Generated on 11/23/2024