



Description

IP66. Class I. IK07. Marine-grade, die-cast aluminum alloy. 5CE superior corrosion protection including PCS hardware. Safety glass lens. Silicone CCG® Controlled Compression Gasket.

Integral EC electronic converter in thermally-separated compartment. Advanced thermal management protects LEDs while optimising lumens output. CAD-optimised optics for superior illumination and glare control. OLC® One LED Concept.

For 2200 K version available on request, except [EES] distribution.

| | |
|---------------------------|--------------------------------|
| Weight | 17.50 kg |
| Light distribution | symmetric, wide beam [B] |
| Light source | LED-36/155W / 1400 mA - 3000 K |
| CRI | 80 |
| Power supply | EC |
| LEDs | 36 |
| Rated input power | 172 W |
| Nominal Lumen (lm) | |
| LED Lumen | 550 |
| Total Lumen | 19800 |
| Tj | 85 |
| Rated lumens (lm) | |
| LED Lumen | 456.7 |
| Total Lumen | 16441.1 |
| Ta | 25 |

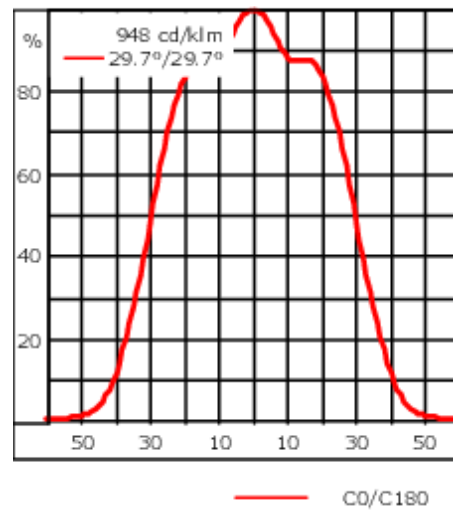
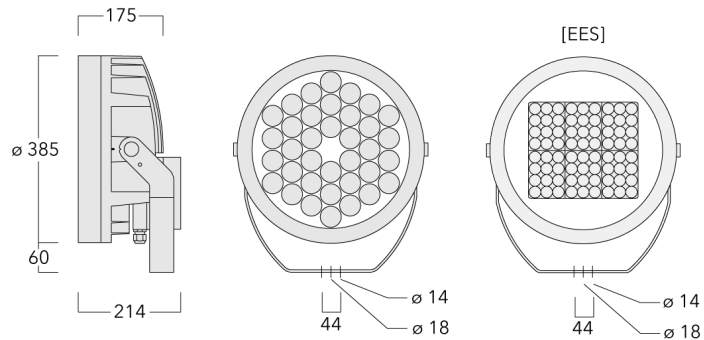

Specifications

Material description

| | |
|----------------------|--|
| Body | Marine-grade, die-cast aluminium alloy |
| Lens | Safety glass lens |
| Colours | <div style="display: flex; align-items: center; gap: 10px;"> <div style="width: 20px; height: 15px; background-color: black; margin-right: 5px;"></div> RAL9004 Signal black <div style="width: 20px; height: 15px; background-color: #808080; margin-right: 5px;"></div> RAL9007 Grey aluminium <div style="width: 20px; height: 15px; background-color: #404040; margin-right: 5px;"></div> RAL7016 Anthracite grey <div style="width: 20px; height: 15px; background-color: #e0e0e0; margin-right: 5px;"></div> RAL9016 Traffic white </div> |
| Gasket | Silicone CCG® Controlled Compression Gasket |
| Ingress protection | IP66 |
| Impact resistance | IK07 |
| Corrosion resistance | 5CE |
| Windage | 0.116 m ² |

Electrical description

| | |
|------------------|---|
| Driver / Ballast | Integral EC electronic converter in thermally-separated compartment |
|------------------|---|

Additional information

| | |
|----------|------------------------|
| Lifetime | Ta=25° L90B10 > 90000h |
|----------|------------------------|

Mounting Accessories

Short post

| Description | Part ID | D1 | D2 | H1 | M1 | Weight (kg) |
|--------------------|----------|-----|-----|-----|----|-------------|
| Short post EM1-M16 | 270-9038 | 160 | 130 | 203 | 9 | 2.10 |

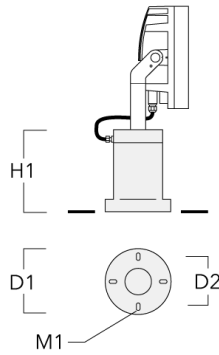

Planted root

| Description | Part ID | D1 | D2 | D3 | D4 | H1 | H2 | M1 | T1 | T2 | Weight (kg) |
|-------------------|-------------|-----|-----|----|----|-----|-----|----|-----|----------|-------------|
| Planted root ESV4 | 300-0461-AP | 150 | 130 | 60 | 89 | 400 | 350 | 8 | 200 | 50 x 100 | 3.85 |

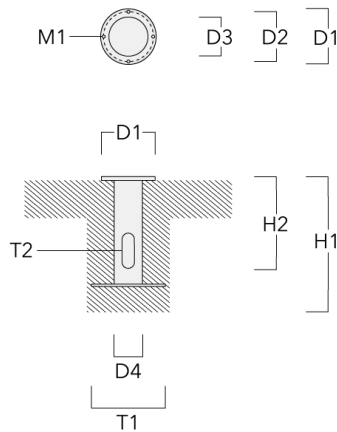

Floodlight mounting bracket TA

| Description | Part ID | A | C1 | D x L1 | Weight (kg) | D x S |
|---|----------|------|-----|----------|-------------|----------|
| TA2-L Mounting bracket, double (Ø 76 x 200) | 147-0105 | ±90° | 420 | 76 x 200 | 16.10 | 76 x 200 |

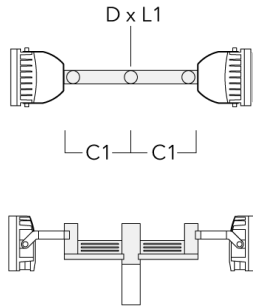

| | | | | | | |
|---|----------|------|-----|----------|-------|----------|
| TA3 Mounting bracket, triple (Ø 89 x 200) | 147-0025 | ±90° | 650 | 89 x 200 | 17.90 | 89 x 200 |
|---|----------|------|-----|----------|-------|----------|

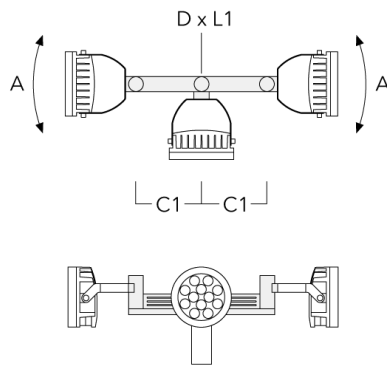

FLC260 LED

| Description | Part ID | A | C1 | D × L1 | Weight (kg) | D × S |
|---|----------|------|-----|----------|-------------|----------|
| TA4 Mounting bracket, quad (Ø 89 x 200) | 147-0099 | ±90° | 650 | 89 x 200 | 20.80 | 89 x 200 |

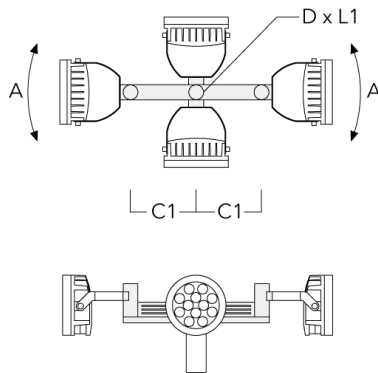

| | | | | | | |
|--|----------|--|-----|-----------|------|-----------|
| TA1 Mounting bracket, single (Ø 108 x 200) | 147-0096 | | 130 | 108 x 200 | 7.50 | 108 x 200 |
|--|----------|--|-----|-----------|------|-----------|

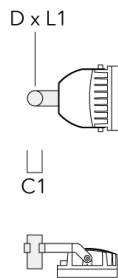

| Description | Part ID | A | C1 | D x L1 | Weight (kg) | D x S |
|--|----------|---|-----|-----------|-------------|-----------|
| TA2 Mounting bracket, double (Ø 108 x 200) | 147-0097 | | 130 | 108 x 200 | 7.50 | 108 x 200 |

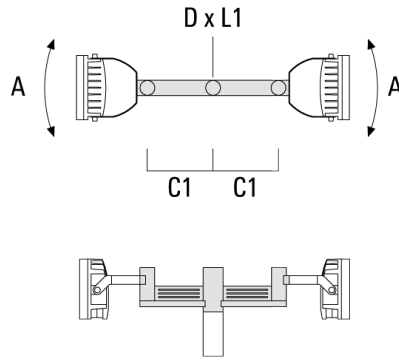

| | | | | | | |
|--|----------|------|-----|-----------|-------|-----------|
| TA3 Mounting bracket, triple (Ø 108 x 200) | 147-0098 | ±90° | 650 | 108 x 200 | 24.20 | 108 x 200 |
|--|----------|------|-----|-----------|-------|-----------|

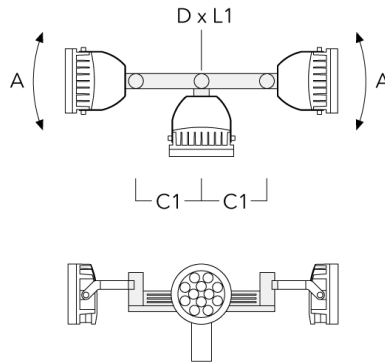

139-1963

FLC260 LED

we-ef

Spigot cap

| Description | Part ID | D1 | Weight (kg) |
|---------------------------------|----------|----------|-------------|
| Spigot Cap KF1-M16 (ø 60 x 100) | 310-9120 | 60 x 100 | 1.40 |

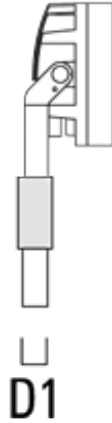

| | | | |
|---------------------------------|----------|----------|-----|
| Spigot Cap KF1-M16 (ø 76 x 100) | 310-9121 | 76 x 100 | 2.2 |
|---------------------------------|----------|----------|-----|

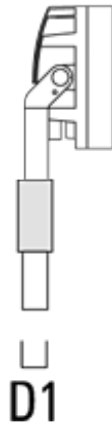

Pole clamp SP - Tilttable

| Description | Part ID | D1 | Weight (kg) | D |
|--------------------------------------|----------|-------|-------------|-------|
| Pole clamp SP1-M16, single (Ø 76-89) | 146-0242 | 76-89 | 1.30 | 76-89 |

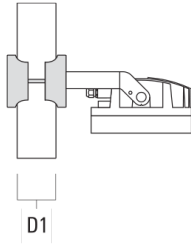

| | | | | |
|--------------------------------------|----------|-------|------|--|
| Pole clamp SP2-M16, double (Ø 76-89) | 146-0244 | 76-89 | 1.50 | |
|--------------------------------------|----------|-------|------|--|

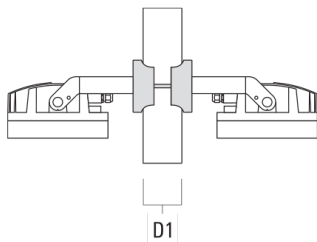

FLC260 LED

| Description | Part ID | D1 | Weight (kg) | D |
|--------------------------------------|----------|-------|-------------|---|
| Pole clamp SP1-M16, single (Ø 38-60) | 146-0241 | 38-60 | 1.30 | |

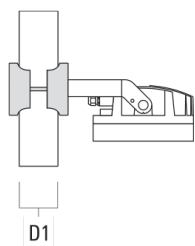

| | | | | |
|--------------------------------------|----------|-------|------|--|
| Pole clamp SP2-M16, double (Ø 38-60) | 146-0243 | 38-60 | 1.50 | |
|--------------------------------------|----------|-------|------|--|

Junction box

| Description | Part ID | Additional information | A | B | C1 | Weight (kg) |
|--|----------|--|-----|-----|----|-------------|
| Junction box JB20 - Cable side entries | 310-9013 | Junction boxes are made from marine-grade, die-cast aluminium alloy. IK10. IP66. For side entries and suitable to be used with cable glands. | 180 | 143 | 51 | 1.02 |

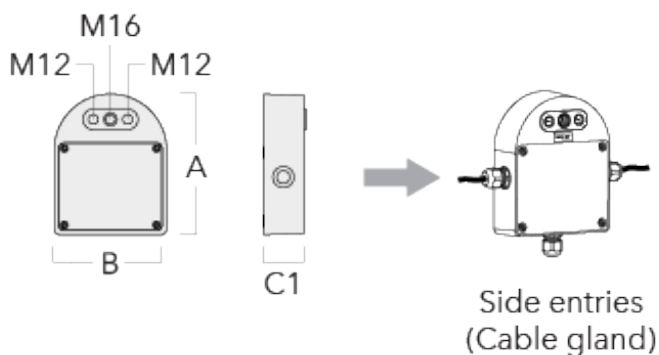

| Description | Part ID | Additional information | A | B | C1 | Weight (kg) |
|--|----------|--|-----|-----|----|-------------|
| Junction box JB20 - Conduit side entries | 310-9014 | Junction boxes are made from marine-grade, die-cast aluminium alloy. IK10. IP66. For side entries and suitable to be used with conduits. | 180 | 143 | 51 | 1.02 |

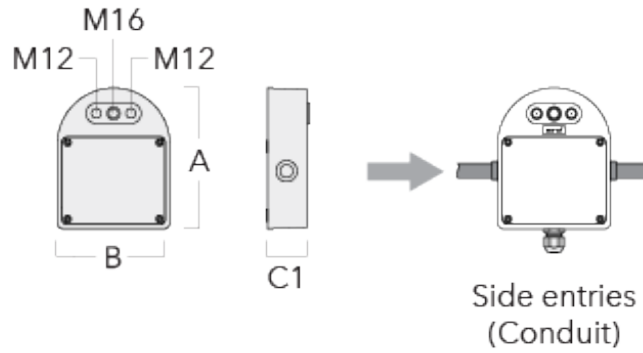

| | | | | | | |
|----------------------------------|----------|--|-----|-----|----|------|
| Junction box JB20 - Wall entries | 310-9018 | Junction boxes are made from marine-grade, die-cast aluminium alloy. IK10. IP66. For wall entries. | 180 | 143 | 51 | 1.02 |
|----------------------------------|----------|--|-----|-----|----|------|

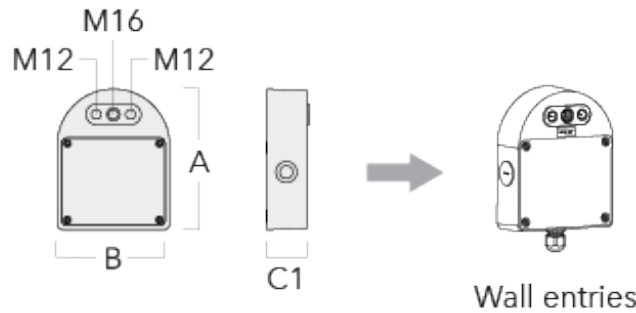

Pole clamp PC - Rotatable

| Description | Part ID | D1 | Weight (kg) |
|---|----------|-------|-------------|
| PC2 76-89/60 Pole clamp, double (Ø 76-89) | 139-2703 | 76-89 | 1.00 |

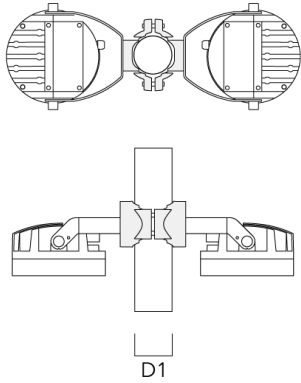

| | | | |
|---|----------|-------|------|
| PC1 76-89/60 Pole clamp, single (Ø 76-89) | 139-2702 | 76-89 | 1.00 |
|---|----------|-------|------|

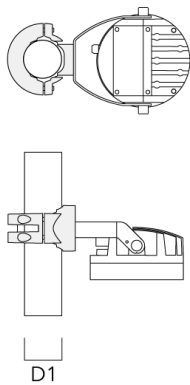

FLC260 LED

| Description | Part ID | D1 | Weight (kg) |
|--|----------|---------|-------------|
| PC2 102-114/60 Pole clamp, double (Ø 102-114) | 139-2707 | 102-114 | 1.20 |



| | | | |
|--|----------|---------|------|
| PC1 102-114/60 Pole clamp, single (Ø 102-114) | 139-2706 | 102-114 | 1.20 |
|--|----------|---------|------|



| Description | Part ID | D1 | Weight (kg) |
|--|----------|---------|-------------|
| PC2 114-133/60 Pole clamp, double (Ø 114-133) | 139-2709 | 114-133 | 1.40 |



| | | | |
|--|----------|---------|------|
| PC1 114-133/60 Pole clamp, single (Ø 114-133) | 139-2708 | 114-133 | 1.40 |
|--|----------|---------|------|



139-1963

FLC260 LED

we-ef

| Description | Part ID | D1 | Weight (kg) |
|--|----------|--------|-------------|
| PC2 82-109/60 Pole camp, double (Ø 82-109) | 139-2705 | 82-109 | 1.10 |



WE-EF LIGHTING (Thailand) Co., Ltd.

57 Moo 5, Kingkaew Rd., Bangplee, 10540 Samutprakarn - Phone: +66 2 738 96 20 - Fax: +66 2 738 96 29

<https://we-ef.com/asia>

Subject to technical changes and errors. - Generated on 23/11/2024

139-1963

FLC260 LED

we-ef

Control

1-10 V analogue dimming interface

| Description | Part ID | C |
|-----------------------------------|----------|----|
| 1-10 V analogue dimming interface | 430-0011 | 90 |

R2C Ready to Connect

| Description | Part ID |
|----------------------------|----------|
| R2C Ready to Connect (top) | 430-0019 |

WE-EF LIGHTING (Thailand) Co., Ltd.

57 Moo 5, Kingkaew Rd., Bangplee, 10540 Samutprakarn - Phone: +66 2 738 96 20 - Fax: +66 2 738 96 29

<https://we-ef.com/asia>

Subject to technical changes and errors. - Generated on 23/11/2024

139-1963

FLC260 LED

we-ef

Optical Accessories

Wallwash lens

| Description | Part ID | C1 |
|---------------------|-------------|-----|
| Wallwash lens IO-20 | 139-1860-AP | 332 |

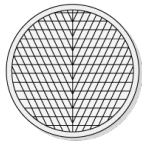

C1

Linear spread lens

| Description | Part ID | C1 |
|---------------------------|----------|-----|
| Linear spread lens IO-180 | 139-1861 | 332 |

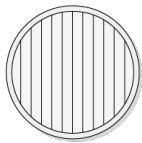

C1

WE-EF LIGHTING (Thailand) Co., Ltd.

57 Moo 5, Kingkaew Rd., Bangplee, 10540 Samutprakarn - Phone: +66 2 738 96 20 - Fax: +66 2 738 96 29

<https://we-ef.com/asia>

Subject to technical changes and errors. - Generated on 23/11/2024

Flood lens

| Description | Part ID | C1 |
|-------------------|----------|-----|
| Flood lens IO-360 | 139-1862 | 332 |

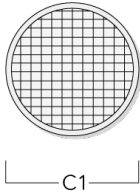

Honeycomb louvre

| Description | Part ID | C1 |
|---------------------|----------|-----|
| Honeycomb louvre IW | 139-1863 | 324 |

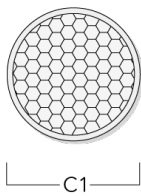

Snoot

| Description | Part ID | A | C1 |
|-------------|----------|-----|-----|
| Snoot ET | 139-1865 | 222 | 393 |

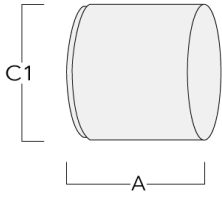

Glare shield

| Description | Part ID | A | C1 |
|-----------------|----------|-----|-----|
| Glare shield ES | 139-1864 | 222 | 393 |

