

## WE-EF LEUCHTEN

Installation and Maintenance  
Instructions

Light column

**LTM440-FT**

**LTM440**



### **Surge Protection**

This product features built-in surge protection circuitry in compliance with applicable standards.

For comprehensive protection of a luminaire installation against lightning and electrical surges, it is essential to cover mains supply and data input lines at the distribution board level, by using respective primary (Type 1) and secondary (Type 2) surge arrestors in compliance with EN61643-11/ IEC61643-1.

### **Warning**

Ensure that all required surge protection measures are in place and activated prior to luminaire installation. Also, disconnect luminaires before operating high-power devices such as, for example, electrical arc welders.

# Light column

## LTM440-FT

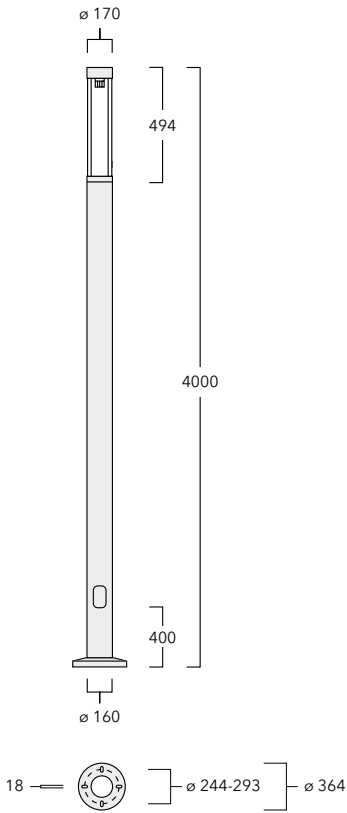

## LTM440

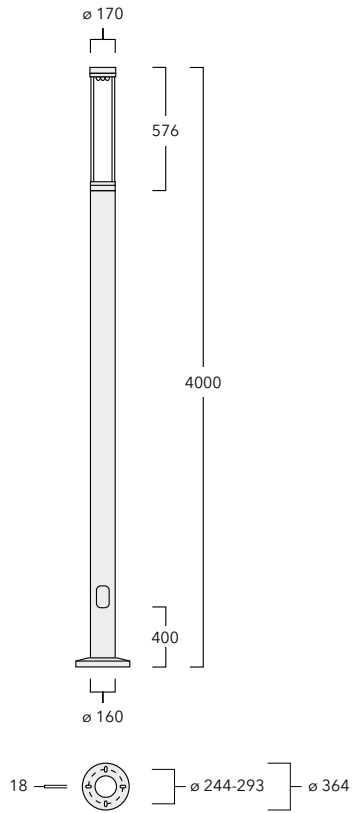

IP55, IK09, Class I,  $t_a = 40^\circ\text{C}$

**Light Source**

LED

**Maintenance**

Apart from cleaning the product's exterior surfaces, no special maintenance work is required.

Do not use high-pressure cleaners.

In case of component failure due to abnormal circumstances or at end of life, replacement must be carried out by a suitably qualified and trained professional.

**Warning:** Do not open luminaire while mains supply is switched on.

## Installation

The product must be installed and maintained by a suitably qualified professional in compliance with latest building/construction and/or electrical regulations and relevant legislation.

**Warning:** Switch off mains electrical supply prior to installing and connecting the luminaire.

**Notice:** If the luminaire is modified by anybody other than the original manufacturer, then the warranty will no longer be valid and shall become the full responsibility of the modifying person/organisation. Claims based on defects attributable to improper installation and/or application, and the consequences thereof, are excluded.

The installation on site must comply with local and/or national health and safety regulations.

## Installation Procedure

It is recommended to incorporate the optional WE-EF planted root to ensure maximum stability.

- 1) Switch off mains electrical supply.
- 2) Check that rating shown on luminaire label conforms with mains electrical supply.
- 3) A suitable recess to be provided for the planted root **A**. Ensure that a solid foundation as well as sufficient mains cable length are provided.
- 4) Remove covers **B** from cast base **C** by loosening screws **D**.
- 5) Set luminaire in position and secure by inserting and tightening bolts **I**.
- 6) Place luminaire head **H** over post **P**, insert plug **G** into socket **K** and tighten screws **J** evenly.
- 7) Loosen screw **N** until door **M** can be opened and removed.
- 8) Loosen screw **Q** and remove cover **R** of cable connecting box **L**.
- 9) Connect mains cable **F** to terminal connector **E**, secure it with strain relief **O** and place back cover **R**.
- 10) Close door **M** and tighten screw **N**.

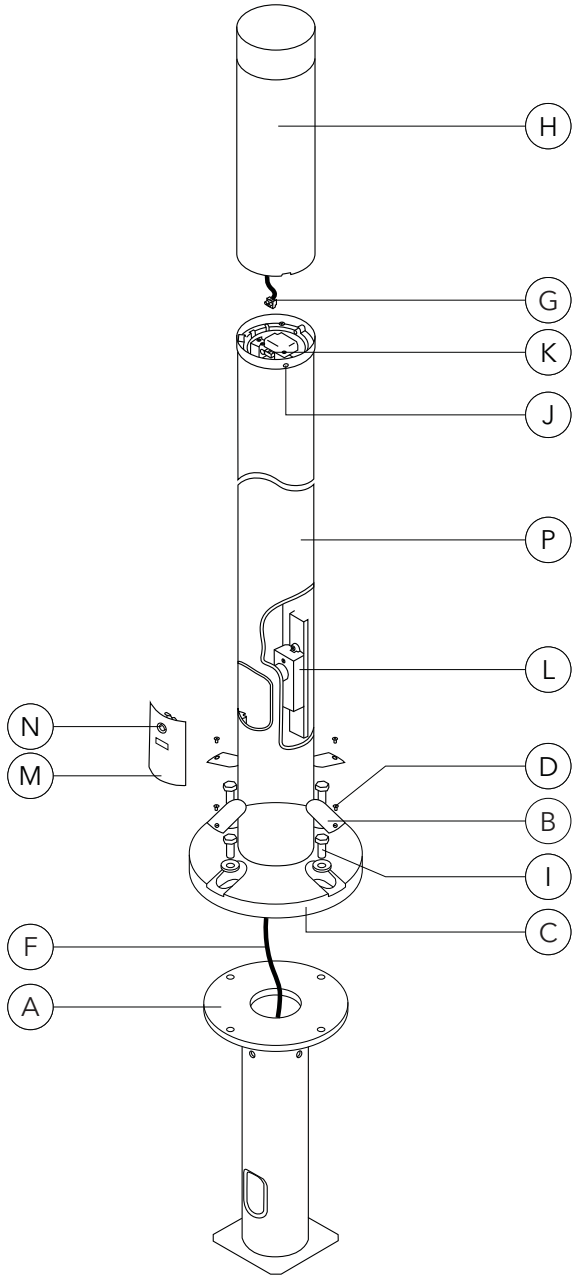

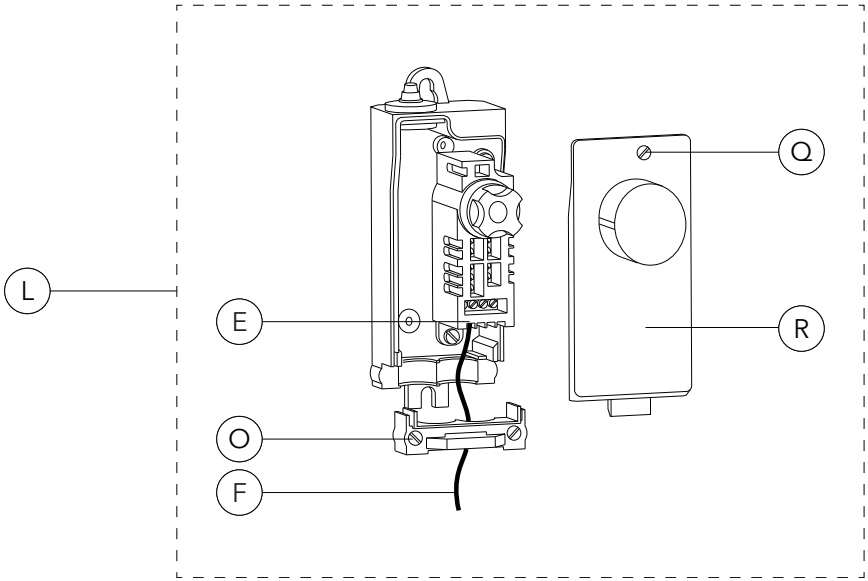

**Cable connecting box EK70**

# **we-ef**

[www.we-ef.com](http://www.we-ef.com)

## **WE-EF LEUCHTEN**

Germany

Tel +49 5194 909 0

Fax +49 5194 909 299

[info.germany@we-ef.com](mailto:info.germany@we-ef.com)

## **WE-EF LUMIERE**

France

Tel +33 4 74 99 14 44

Fax +33 4 74 99 14 40

[info.france@we-ef.com](mailto:info.france@we-ef.com)

## **WE-EF SWITZERLAND**

Switzerland

Tel +41 22 752 49 94

Fax +41 22 752 49 74

[info.switzerland@we-ef.com](mailto:info.switzerland@we-ef.com)

## **WE-EF LIGHTING**

Thailand

Tel +66 2 738 9610

Fax +66 2 175 2174

[info.asiapacific@we-ef.com](mailto:info.asiapacific@we-ef.com)

## **WE-EF LIGHTING**

Australia

Tel +61 3 8587 0444

Fax +61 3 8587 0499

[info.australia@we-ef.com](mailto:info.australia@we-ef.com)

## **WE-EF LIGHTING**

United States of America

Tel +1 724 742 0030

Fax +1 724 742 0035

[info.usa@we-ef.com](mailto:info.usa@we-ef.com)

TO9230W0823 © WE-EF 2023

Technical specifications are  
subject to change.

**WE-EF LEUCHTEN**

Installation and Maintenance  
Instructions

Planted Root

**ESV4**

**ESV2**

**ESV6**



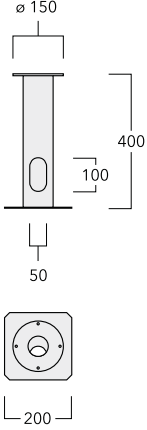
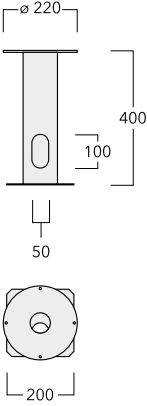
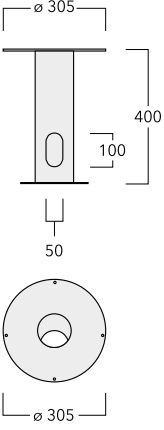
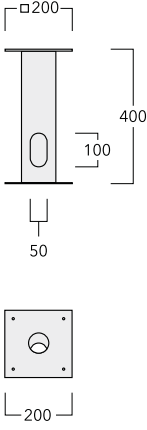

**Planted Root**

<p><b>ESV4 300-0461</b></p> <p><b>Suitability</b></p> <ol style="list-style-type: none"> <li>1. KTX234</li> <li>2. KTY234</li> <li>3. ZFY230</li> <li>4. GRY224</li> <li>5. Short post</li> </ol> 	<p><b>ESV4 300-0464</b></p> <p><b>Suitability</b></p> <ol style="list-style-type: none"> <li>1. CFY259</li> <li>2. GRY234</li> <li>3. RRY324</li> <li>4. RRZ324</li> <li>5. XRY324</li> <li>6. XRZ324</li> </ol> 
<p><b>ESV4 300-0586</b></p> <p><b>Suitability</b></p> <ol style="list-style-type: none"> <li>1. XRY334</li> <li>2. XRZ334</li> <li>3. RRY334</li> <li>4. RRZ334</li> </ol> 	<p><b>ESV4 300-0459</b></p> <p><b>Suitability</b></p> <ol style="list-style-type: none"> <li>1. QSI254</li> </ol> 

## Planted Root

**ESV2 300-9115**

### Suitability

1. PSY414/424

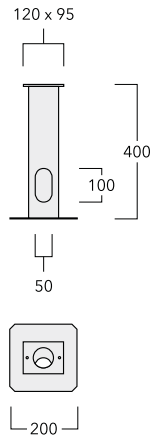

**ESV6 300-0457**

### Suitability

1. LTM440
2. LTM444
3. AMW-C
4. AMF-C
5. AMF-S
6. AML-C

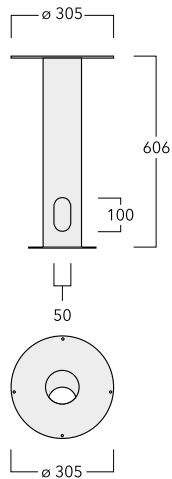

**ESV6 300-0824**

### Suitability

1. AML-C
2. FLA461

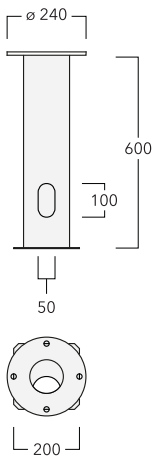

## Installation Instruction

- 1) Note: It is the responsibility to installer to ensure the suitability of the ESV planted root for any local or national structural requirements for installation, and that planted root is suitable for site specific conditions.

Instructions are a guideline for installation to these requirements and provide detail for installation orientation and mounting details.

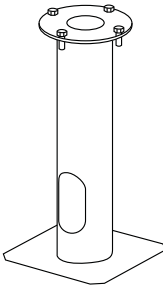

- 2) Please note, ESV4 and ESV6 must be orientated correctly for different products. In both instances conduit entry can be rotated to match cable routing.

When the ESV is being installed for following products: KTY234/KTX234/ZFY230/CFY259/FLA461, please orientate the planted root as shown (base plate is at an angle of 45° to the pathway). For this installation, use the 40 mm long M8 bolts supplied.

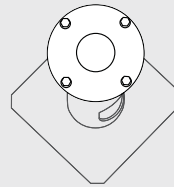

- 3) For all other product that use ESV4 please orientate planted root as shown (base plate is parallel to the pathway). For this installation, use 25 mm long M8 bolts supplied.

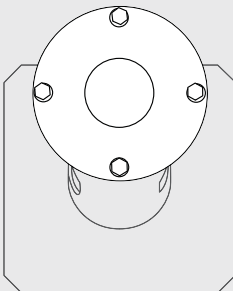

- 4) For ESV2 please orientate planted root as shown (base plate is parallel to the pathway). For this installation, use 30 mm long M12 bolts supplied.

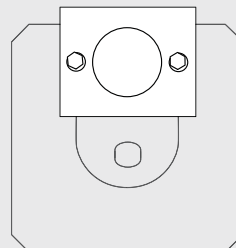

5) For all other product that use ESV6 please orientate planted root as shown (base plate is parallel to the pathway). For this installation, use 40 mm long M16 bolts supplie.

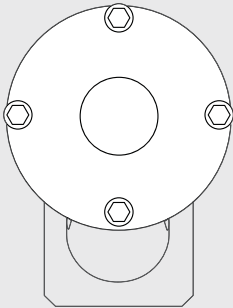

6) Orientate ESV as required and fit electrical connections/conduit.

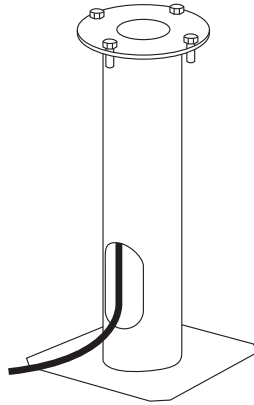

7) Place the ESV in the form work for concrete pad, ensuring orientation, position and levels are correct. Ensure all openings on ESV are blanked off, including mounting plate hole.

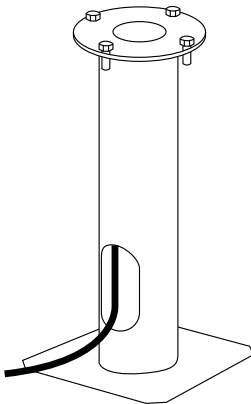

8) Fit the nominated bolts through mounting flange. Ensure several threads feed through the plate and tape off top and bottom. Bolts are inserted to protect threads off plate and need to be removed for fitting installation after setting the ESV.

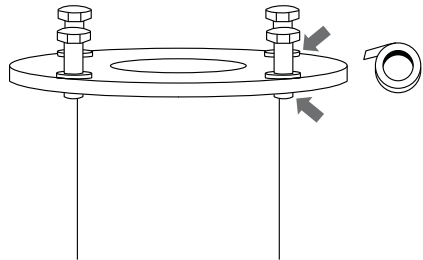

9) Pour concrete to desired level depending on requirement of concrete, paver or soil. Ensure that for any installation mounting flange must be flush or higher than surrounding surface level.

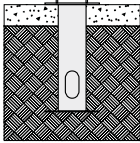

Concrete

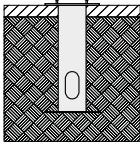

Paver

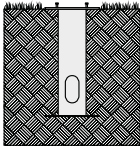

Soil

10) After concrete has cured for specified time, remove blanking and bolts. Install fitting (as per luminaire instructions) onto mounting flange.

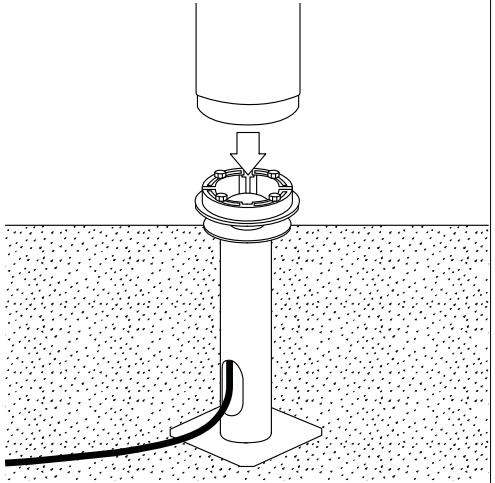



[www.we-ef.com](http://www.we-ef.com)

**WE-EF LEUCHTEN**

Germany

Tel +49 5194 909 0

Fax +49 5194 909 299

[info.germany@we-ef.com](mailto:info.germany@we-ef.com)

**WE-EF LUMIERE**

France

Tel +33 4 74 99 14 44

Fax +33 4 74 99 14 40

[info.france@we-ef.com](mailto:info.france@we-ef.com)

**WE-EF HELVETICA**

Switzerland

Tel +41 22 752 49 94

Fax +41 22 752 49 74

[info.switzerland@we-ef.com](mailto:info.switzerland@we-ef.com)

**WE-EF LIGHTING**

Thailand

Tel +66 2 738 9610

Fax +66 2 175 2174

[info.asiapacific@we-ef.com](mailto:info.asiapacific@we-ef.com)

**WE-EF LIGHTING**

Australia

Tel +61 3 8587 0444

Fax +61 3 8587 0499

[info.australia@we-ef.com](mailto:info.australia@we-ef.com)

**WE-EF LIGHTING**

United States of America

Tel +1 724 742 0030

Fax +1 724 742 0035

[info.usa@we-ef.com](mailto:info.usa@we-ef.com)

TO9257W0823 © WE-EF 2023

Technical specifications are  
subject to change.