

WE-EF LEUCHTEN

Installation and Maintenance
Instructions

Bollards and Pathway Luminaires
MRY224



Do not open during installation

This product is factory-sealed.
Refer to the instructions contained
in this document for details.



Installation tools

Mounting hardware used on this product
includes fasteners with hexalobular
socket heads (ISO 10664). Installation
requires the use of matching tools.



Surge Protection

This product features built-in surge protection circuitry in compliance
with applicable standards.

For comprehensive protection of a luminaire installation against lightning
and electrical surges, it is essential to cover mains supply and data input
lines at the distribution board level, by using respective primary (Type 1)
and secondary (Type 2) surge arrestors in compliance with EN61643-11/
IEC61643-1.

Warning

Ensure that all required surge protection measures are in place and
activated prior to luminaire installation. Also, disconnect luminaires
before operating high-power devices such as, for example, electrical
arc welders.

Bollards and Pathway Luminaires

MRY224

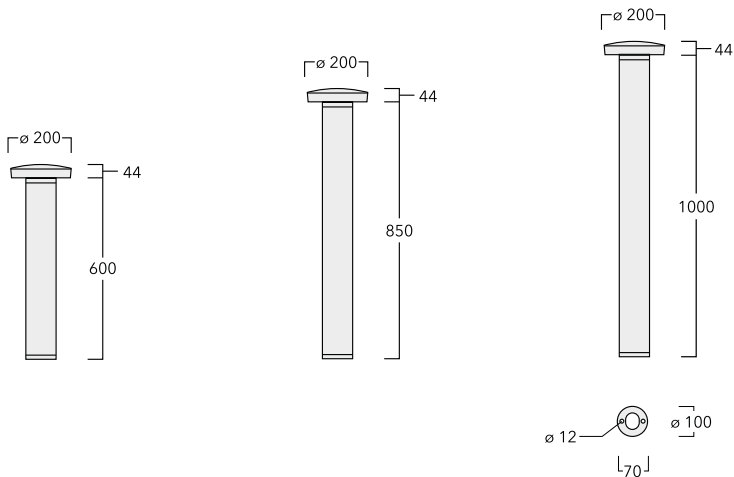

IP66, IK10, $T_a = 25^\circ\text{C}$ for 15 W with 1-10 V dimming, for other $T_a = 40^\circ\text{C}$

Tool required

- Torx T25 (provided by WE-EF)

Weight	H	kg
for MRY224	600	8.0
for MRY224	850	10.8
for MRY224	1000	12.4

Accessories:

Planted root - Galvanised steel.		kg
ESZ4	for MRY224	300-9090 3.5

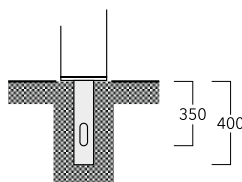

ESZ4

Light Source

LED

Maintenance

Apart from cleaning the product's exterior surfaces, no special maintenance work is required.

Do not use high-pressure cleaners.

In case of component failure due to abnormal circumstances or at end of life, replacement must be carried out by a suitably qualified and trained professional.

Warning: Do not open luminaire while mains supply is switched on.

Installation

The product must be installed and maintained by a suitably qualified professional in compliance with latest building/construction and/or electrical regulations and relevant legislation.

Warning: Switch off mains electrical supply prior to installing and connecting the luminaire.

Notice: If the luminaire is modified by anybody other than the original manufacturer, then the warranty will no longer be valid and shall become the full responsibility of the modifying person/organisation. Claims based on defects attributable to improper installation and/or application, and the consequences thereof, are excluded.

Attention: The luminaire is factory-sealed and does not need to be opened during installation.

The installation on site must comply with local and/or national health and safety regulations.

Installation Procedure

1) Switch off mains electrical supply.

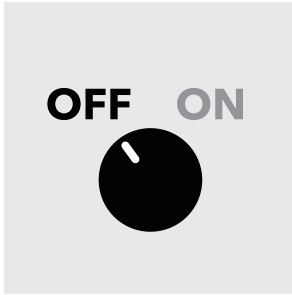

2) Loosen screw **A**.

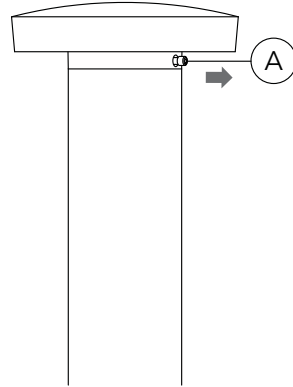

3) Remove sleeve **B** including luminaire head from post **C**.

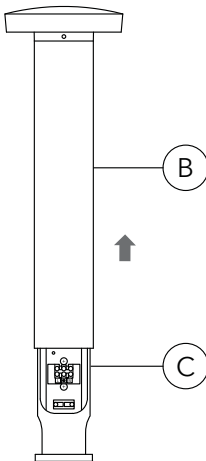

4.1) Pull cable **D** through membrane spout.

Ensure orientation of post **C** allows easy access to terminal block **G** and screw flange plate **E** with M10 bolts/nuts to ground.

An optional planted root is available.

Note: Planted root installation instruction is available in additional document.

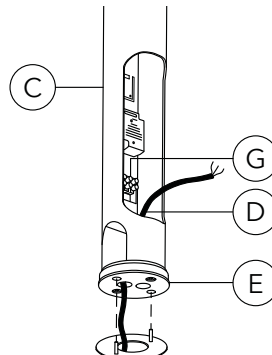

4.2) For one-sided light output only, the direction of light is opposite terminal block **G**.

Orientation of light must be decided prior to installation of post **C**.

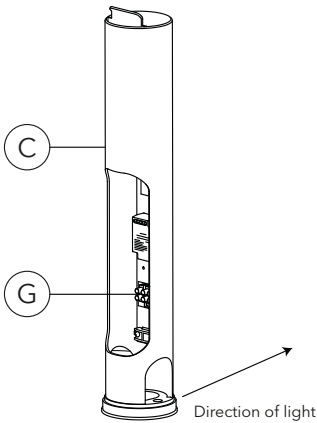

5) Check that rating shown on luminaire label conforms to mains electrical.

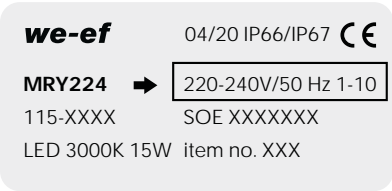

(example)

6) Pull cable **D** (and second cable for through wiring, if required) through cable clamp **F** and terminate in terminal block **G**:

- a) ON/OFF (L = Phase, N = Neutral, ⊕ = Earthing)
- b) 1-10 V/DALI (L = Phase, N = Neutral, ⊕ = Earthing, DA/DA = DALI control line, D-/D+ = 1-10 V control line).

For operation with Tunable White, a DALI DT8 controller is required.

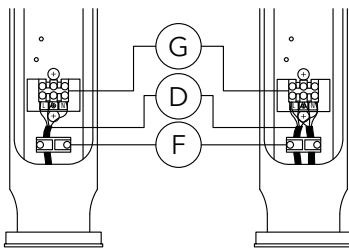

7) Place sleeve **B** including luminaire head over post **C** while keeping screw **A** in line with terminal box.

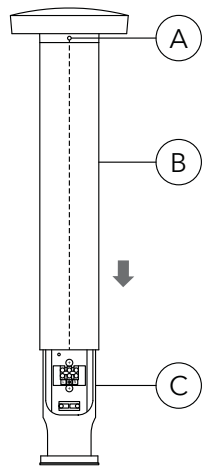

8) Align sleeve **B** and flange plate **E**.

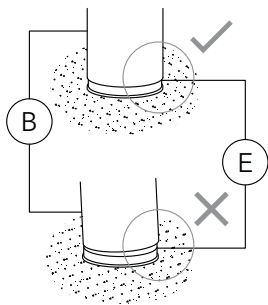

9) Tighten screw **A** with Torx T25 tool (provided by WE-EF).

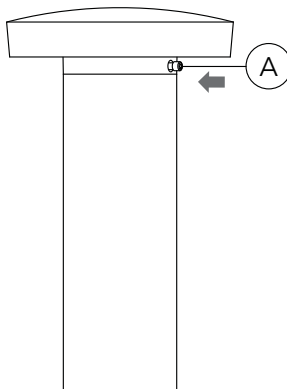

we-ef

www.we-ef.com

WE-EF LEUCHTEN

Germany

Tel +49 5194 909 0

Fax +49 5194 909 299

info.germany@we-ef.com

WE-EF LUMIERE

France

Tel +33 4 74 99 14 44

Fax +33 4 74 99 14 40

info.france@we-ef.com

WE-EF SWITZERLAND

Switzerland

Tel +41 22 752 49 94

Fax +41 22 752 49 74

info.switzerland@we-ef.com

WE-EF LIGHTING

Thailand

Tel +66 2 738 9610

Fax +66 2 175 2174

info.asiapacific@we-ef.com

WE-EF LIGHTING

Australia

Tel +61 3 8587 0444

Fax +61 3 8587 0499

info.australia@we-ef.com

WE-EF LIGHTING

United States of America

Tel +1 724 742 0030

Fax +1 724 742 0035

info.usa@we-ef.com

TO9268W1222 © WE-EF 2022

Technical specifications are
subject to change.

WE-EF LEUCHTEN

Installation and Maintenance
Instructions

Planted Root

ESV4

ESV6

ESZ4



Planted Root

ESV4 300-0461

Suitability

1. KTX234
2. KTY234
3. ZFY230
4. GRY224
5. Short post

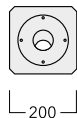
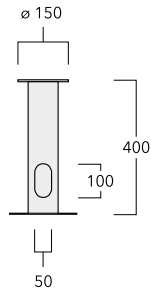

ESV4 300-0464

Suitability

1. CFY259
2. GRY234
3. RRY324
4. RRZ324
5. XRY324
6. XRZ324

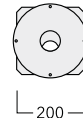
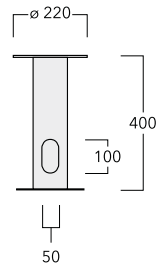

ESV4 300-0586

Suitability

1. XRY334
2. XRZ334
3. RRY334
4. RRZ334

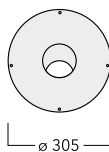
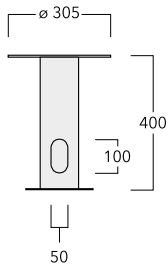

ESV4 300-0459

Suitability

1. QSI254

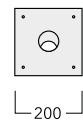
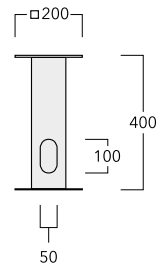

Planted Root

ESV6 300-0824

Suitability

- 1. AML-C
- 2. FLA461

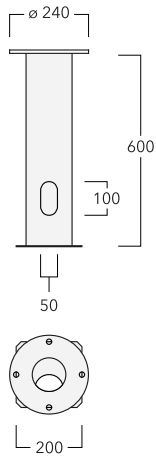

ESV6 300-0457

Suitability

- 1. LTM440
- 2. LTM444
- 3. AMW-C
- 4. AMF-C
- 5. AMF-S
- 6. AML-C

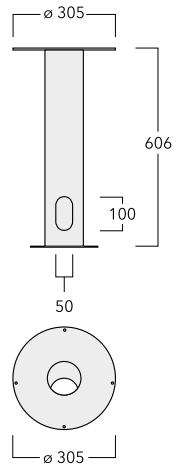

ESZ4 300-9115

Suitability

- 1. PSY414/424

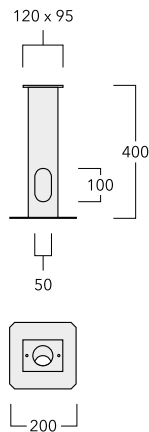

ESZ4 300-9090

Suitability

- 1. MRY224

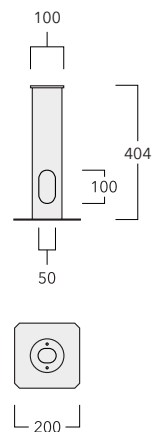

Installation Instruction

- 1) Note: It is the responsibility to installer to ensure the suitability of the ESV/ESZ planted root for any local or national structural requirements for installation, and that planted root is suitable for site specific conditions.

Instructions are a guideline for installation to these requirements and provide detail for installation orientation and mounting details.

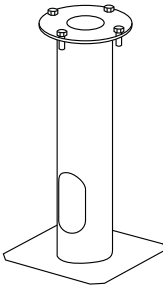

- 2) Please note, ESV4 and ESV6 must be orientated correctly for different products. In both instances conduit entry can be rotated to match cable routing.

When the ESV is being installed for following products: KTY234/KTX234/ZFY230/CFY259/FLA461, please orientate the planted root as shown (base plate is at an angle of 45° to the pathway). For this installation, use the 40 mm long M8 bolts supplied.

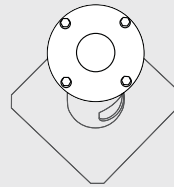

- 3) For all other product that use ESV4 please orientate planted root as shown (base plate is parallel to the pathway). For this installation, use 25 mm long M8 bolts supplied.

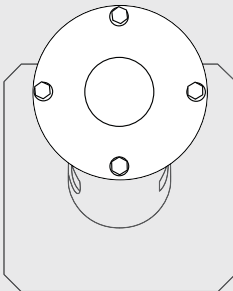

- 4) For all other product that use ESV6 please orientate planted root as shown (base plate is parallel to the pathway). For this installation, use 40 mm long M16 bolts supplied.

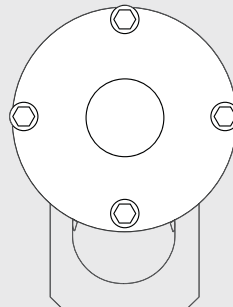

- 5) For ESZ4 please orientate planted root as shown (base plate is parallel to the pathway). For this installation, use 30 mm long M12 bolts for PSY planted root and 35 mm long M10 bolts for MR Y planted root.

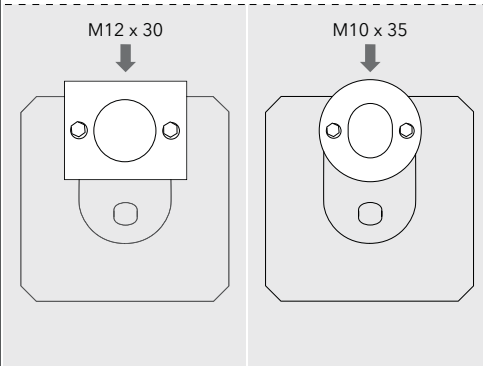

- 6) Orientate ESV/ESZ as required and fit electrical connections/conduit.

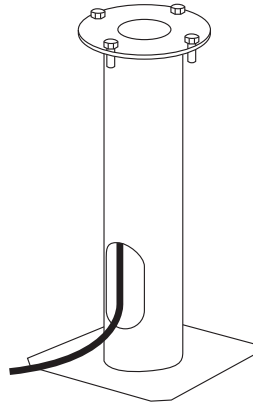

- 7) Place the ESV/ESZ in the form work for concrete pad, ensuring orientation, position and levels are correct. Ensure all openings on ESV/ESZ are blanked off, including mounting plate hole.

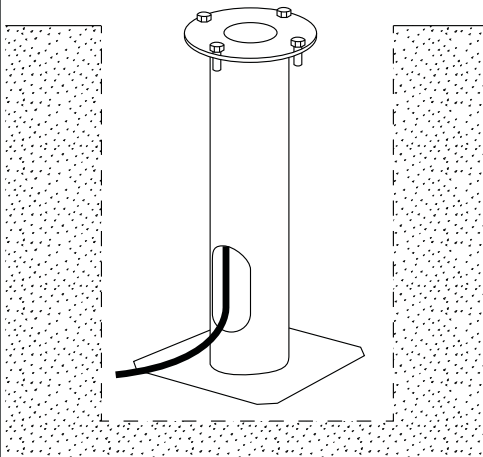

- 8) Fit the nominated bolts through mounting flange. Ensure several threads feed through the plate and tape off top and bottom. Bolts are inserted to protect threads off plate and need to be removed for fitting installation after setting the ESV/ESZ.

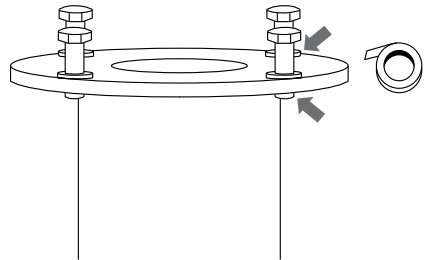

9) Pour concrete to desired level depending on requirement of concrete, paver or soil. Ensure that for any installation mounting flange must be flush or higher than surrounding surface level.

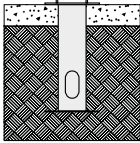

Concrete

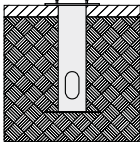

Paver

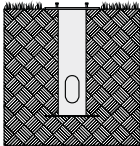

Soil

10) After concrete has cured for specified time, remove blanking and bolts. Install fitting (as per luminaire instructions) onto mounting flange.

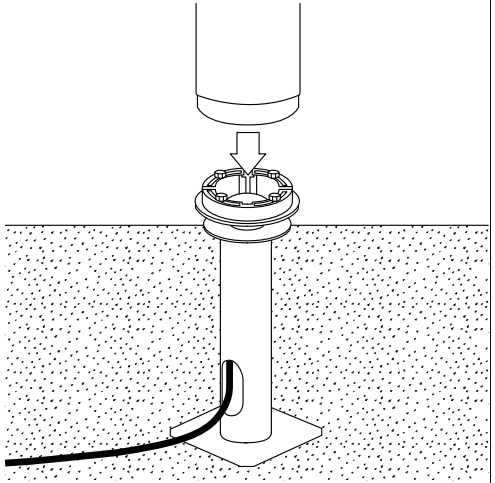



www.we-ef.com

WE-EF LEUCHTEN

Germany

Tel +49 5194 909 0

Fax +49 5194 909 299

info.germany@we-ef.com

WE-EF LUMIERE

France

Tel +33 4 74 99 14 44

Fax +33 4 74 99 14 40

info.france@we-ef.com

WE-EF HELVETICA

Switzerland

Tel +41 22 752 49 94

Fax +41 22 752 49 74

info.switzerland@we-ef.com

WE-EF LIGHTING

Thailand

Tel +66 2 738 9610

Fax +66 2 175 2174

info.asiapacific@we-ef.com

WE-EF LIGHTING

Australia

Tel +61 3 8587 0444

Fax +61 3 8587 0499

info.australia@we-ef.com

WE-EF LIGHTING

United States of America

Tel +1 724 742 0030

Fax +1 724 742 0035

info.usa@we-ef.com

TO9257W0124 © WE-EF 2024

Technical specifications are
subject to change.