



WE-EF LIGHTING USA LLC

410-D Keystone Drive
Warrendale, PA 15086
USA
Tel +1 724 742 0030
Fax +1 724 742 0035
info.usa@we-ef.com
www.we-ef.com

Technical specifications are subject to change
© WE-EF 2013



WE-EF LIGHTING USA LLC

Installation and Maintenance
Instructions for Steplights
STO / STP / STG / STL
STN / STX
SVO / SVL

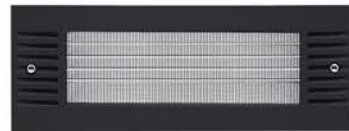
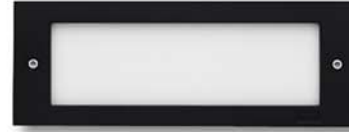

**Installation and Maintenance
Instructions for
Steplights series:**

**STO209 STG209 STN204
STP204 STL209 STX209**

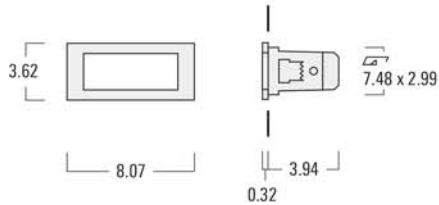

**STO259 STP254 STG259
STL259 STN254 STX259**

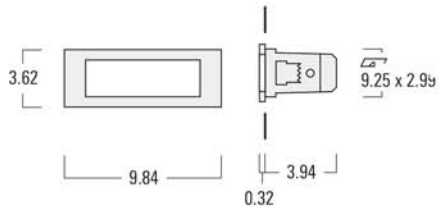

SVO259 SVL259

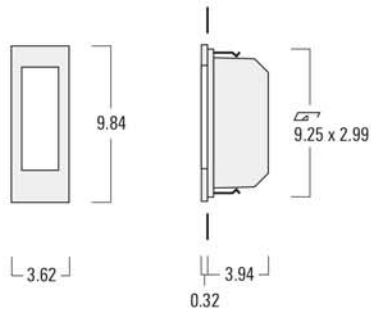

Light source:

CFQ 13 - 18W
LED 4 - 6W

This product should be installed in accordance with the applicable installation code by a person familiar with the construction and operation of the product and the hazards involved. Be sure the electrical supply is off prior to installation.

Do not install insulation within 3" of any part of the luminaire.

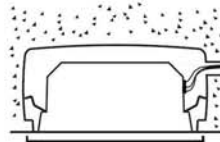

Installation with optional #BST20 or #BST25 Blockout

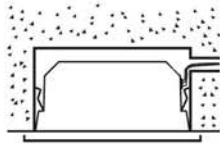

Installation without #BST20 or #BST25 Blockout

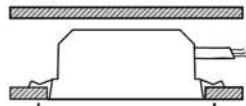

Installation in hollow wall, no blockout required

1. Switch off the electrical supply.
2. Remove frame A, lens B, by releasing the two hex socket screws C. Remove the internal cover plate D that is attached with two phillips head screws.
3. Check that the electrical supply conforms with the ratings shown on the luminaire label.

4. Check that the recess provided will accommodate the luminaire housing. Feed the electrical supply conductors thru the hole(s) in the ends of the housing, while setting the luminaire into position. Secure the luminaire by tightening the two phillips head screws G, which will activate the two claws H.

5. Connect the electrical supply conductors to the ballast leads per the wiring diagram on the ballast.

6. Attach the cover plate D.

7. Install the appropriate lamp J into the lampholder (not required for LED)

8. Replace the lens and secure in position together with the frame by evenly tightening the two hex socket screws.

Lamp Replacement and Maintenance:

Do not open luminaire while in operation or while mains supply is switched on!

1. Switch off the electrical supply.
2. Open luminaire and clean all exterior surfaces.
3. Replace lamp (for LED replacement, the whole LED gear tray needs to be replaced)
4. Check gasket for dirt and damage and clean or replace if necessary.
5. Close luminaire.

Protect our environment: Discard used lamps in compliance with the most recent environmental legislation.

