

we-ef

WE-EF LEUCHTEN
General Catalogue
European Edition
2016–2018



WE-EF is a global manufacturer of high-performance exterior luminaires renowned for outstanding engineering design and innovative optical systems. Established in 1950 in Germany, WE-EF is recognised worldwide as a leading exterior lighting specialist that provides professional lighting solutions for various applications, ranging from urban spaces to architectural projects.

As a pioneer and innovator of a wide range of application-specific modular LED lens technologies, WE-EF develops optical systems that deliver photometric efficiency together with high visual comfort.

WE-EF is dedicated to the philosophy of combining form and function, resulting in striking and timeless product designs.

Precision in the design process, careful consideration of material selection and high-quality manufacturing processes; ensures that WE-EF luminaires are considered to be a benchmark of product performance, reliability and longevity; as well as ease of installation.

Responsible resource management is practiced across all areas of operation, from product life-cycle assessments to sustainable business procedures.

Cover photo: CFT540 made by WE-EF

12	Underwater floodlights
18	Inground luminaires
54	Wall luminaires recessed
76	Wall luminaires surface mounted
114	Ceiling luminaires
136	Bollards and pathway luminaires
154	Light columns
172	Street and area lighting
260	Eco Step Dim®
266	RAIL66 system
286	Projectors
326	Floodlights
340	Area floodlights
370	Accessories
378	Poles
398	Technical information
429	Series index
430	Product index
440	Contact information

THE INTELLIGENCE OF
LIGHT®

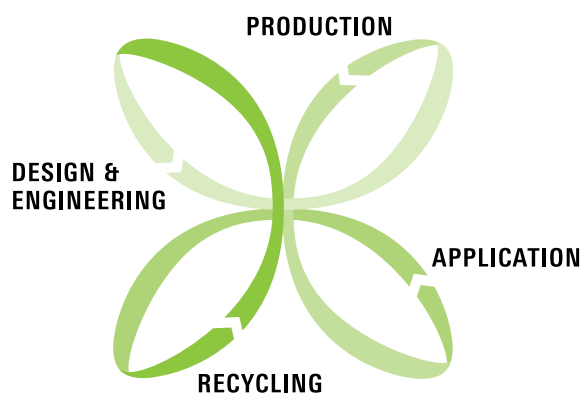

Design and Engineering

The most important element in the design process is the development of luminaires that encompass timeless design; in other words, design that best reflects their enduring qualities.

In addition, state-of-the-art engineering brings with it the highest standards with regard to environmentally-friendly materials and processes, i.e., high IP ratings, excellent thermal management and innovative optical systems. The development of high-end, efficient reflectors and lenses is one of the core competencies of WE-EF. This means compliance with international lighting and safety norms, while meeting the criteria of such organisations as the Dark Sky Society. Continual investment in research and development is the basic condition for meeting these requirements. WE-EF innovations, such as IOS® Innovative Optical Systems, CTA® Cool Touch Adaptor, ASC Anti Slip Coating and OLC® One LED Concept, are just some examples of the company's continuing investment in technology.

The most significant WE-EF contribution to protecting the environment is the creation of products that are engineered to endure, essentially minimising the need to replace or recycle them for many years.

Production

'Made by WE-EF' is more than just an expression; the high quality level of in-house production processes includes:

- Tooling for HPDC and injection moulding
- Aluminium high-pressure die-casting
- CNC machining
- Powdercoating
- Pole manufacturing
- Assembly

Through continual investment in tooling, production processes and the ongoing education of our employees, we are able to achieve the highest standards of quality. In exterior lighting, the corrosion resistance qualities of a product are important for their reliability and longevity. A durable and reliable corrosion protection can only be achieved when Product Development and the Production Processes are considered together. Years of research, development and practical testing and experience in some of the harshest climates on earth has resulted in WE-EF's unique 5CE corrosion protection system. It encompasses five critical elements; Material, Conversion Coating, Powder Coating, PCS Polymer Coated Stainless Hardware and Process Control. Only complete systems such as 5CE can provide reliability and longevity in exterior environments.

Application

Real and sustainable cost and energy savings can only be achieved through professional project planning, including the application of the latest optical systems and light sources. In streetlighting applications, for example, this means minimising the number of luminaires required by optimising the efficiency of the optical system, while at the same time limiting glare in line with international standards. In short, reduced installation and maintenance costs, less CO₂ and improved quality of light.

Recycling

More than 90 per cent of a WE-EF luminaire can be recycled. The main component, a marine-grade aluminium substrate, is refined from recycled aluminium. This recycled aluminium is also an 'energy storer'. Only 5 per cent of the original energy needed to process bauxite into aluminium is required for recycling. In other words, 95 per cent of the original energy input is also recycled.

Worldwide performance

With its in-depth understanding of regional practises and environmental standards, WE-EF provides architects, lighting designers and project consultants with comprehensive support for architectural and urban lighting projects.

Established more than 65 years ago in Germany, the WE-EF Group now comprises seven companies worldwide - each fully supported by an extensive network of regional distributors and agents.

● WE-EF group worldwide

WE-EF LEUCHTEN Germany

WE-EF LIGHTING United Kingdom

WE-EF LUMIERE France

WE-EF HELVETICA Switzerland

WE-EF LIGHTING United States of America

WE-EF LIGHTING Thailand

WE-EF LIGHTING Australia



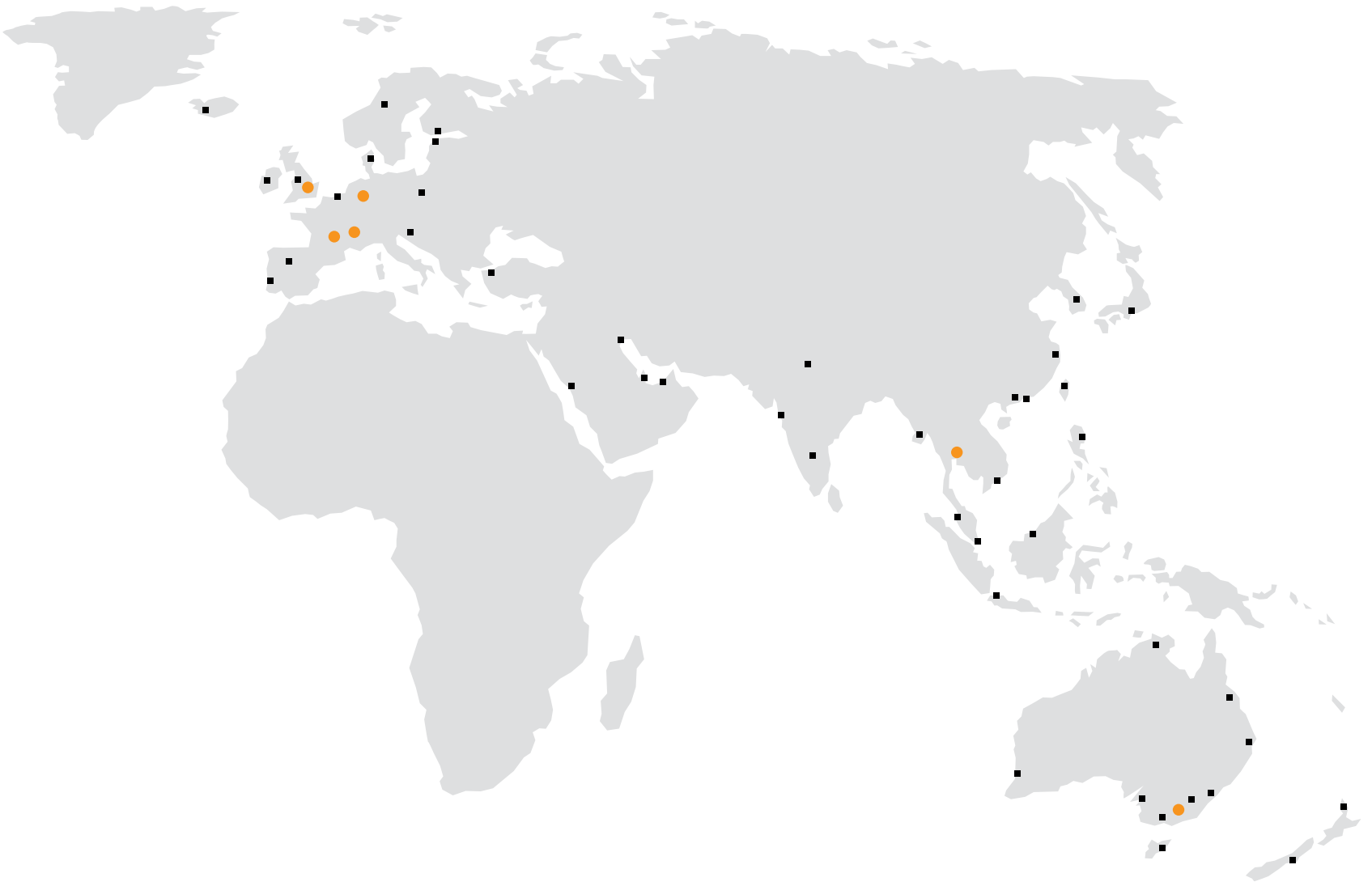



EFC100

20

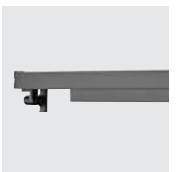

VLR100

78

Luminaires and accessories

Underwater floodlights



ULC200 14

Inground luminaires



ESC100 22

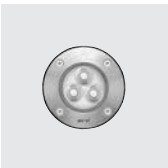

ETC100 24



ETC100 28



ETC100-GB 30



ETC300-GB 34



ETC300 36



ETV100 38



ETR100 42

Wall luminaires recessed

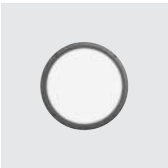

TRO200 56



STO/STL/SVL100 58



STI/STF100 60

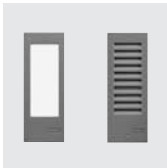

SVO/SVL200 62



STO/STL200 64



STI200 66

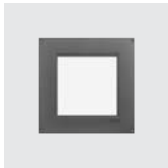

QRO300 68



QRI300 70

Wall luminaires surface mounted



UDN300 82



QLS400 86



VLS400 90



SLS400 94

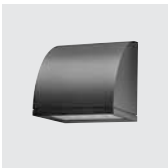

OLV300 98



PIA200 106



DLO/DLG200 110



XLO200 112

Ceiling luminaires



DOC200-GB 116



DOC200 120



DAC200-GB 126



DAC200 128



PFL500

218

Luminaires and accessories

Bollards and pathway luminaires



XRX / XRY300 140 KTY200 142 ZFY200 144 CFY200 146 NTY100 148

Light columns



LSP / LTP400 156 LTM / LSM400 160 LTC400 164 LCI400 166 LGI400 168

Street and area lighting



ZFT400 174 ZA600 180 RMC300 184 RMT300 188 CFT500 190 RFS500 192 RFL500-SE 194 VFL500 206



PFL200 224 EFL500 242 AL500 246 ALP500 248 AOP500 250 ASP500 252 BSP500 254 Eco Step Dim 260

RAIL66 system

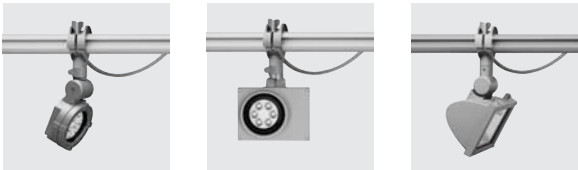

FLC100 268 FLD100 272 FLB100 274

Luminaires and accessories

Projectors



FLC100 288



FLC100 290

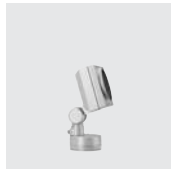

FLD100 298



FLC200 302



FLC200 CC 316



FLC200 BL 318



FLC200 CC + BL 320

Floodlights

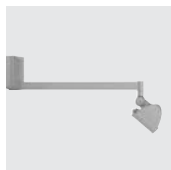

FLB100 328



FLB400 330

Area floodlights



FLA700 342



FLA400 358

Accessories



Gear boxes and Gear trays 372



Surge protection 374



Pole accessories 376



Cable connecting boxes 377

Poles

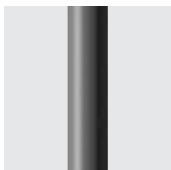

AM-Z 380



AMW-Z 382

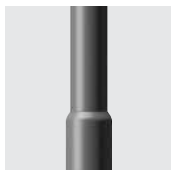

AM-R 384



AM-S 386

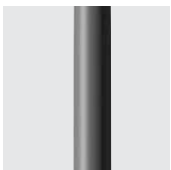

AM-K 388

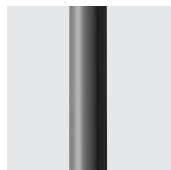

AML-K 390



AM-V 392

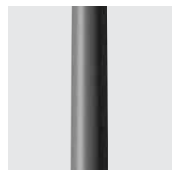

FM-K 394

Technical information

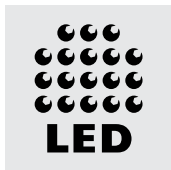

LED Engineering 400

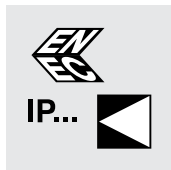

Standards 414

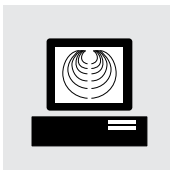

Lighting data and Project support 418

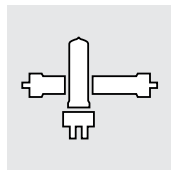

Lamp chart 424

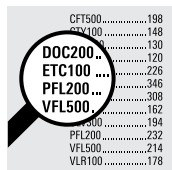

Series index 429

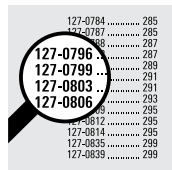

Product index 430

IOS® Beam distributions for underwater floodlights

- [M] medium beam, symmetric
- [EE] very narrow beam, symmetric

Underwater floodlights



ULC200 LED

14



ACCESSORIES

■ Electrical

16

■ Optical

16

ULC200 SERIES

Underwater floodlight, medium or very narrow beam distribution.

IP68 (up to 10 m). ULC210: Class III. IK09. ULC230: Class I. IK10. Body, lens frame constructed in stainless steel, PCS hardware. Safety glass lens. Silicone rubber gasket.

Factory sealed termination chamber complete with 10 m of flexible PVC free cable.

IP68 in-line connector.

Factory installed LED circuit board. LED boards can be easily removed for upgrading.

PMMA LED lens array.

Suitable for continuously submerged applications in all types of pools, including saltwater.

Installation and operation of these floodlights are subject to national electrical and safety regulations for underwater lighting.

Light source

LED 2-24 W, 3000 K,
for 4000 K refer to www.we-ef.com

Light distributions

[M] [EE]

Accessories

- Electrical, page 16
- Optical, page 16

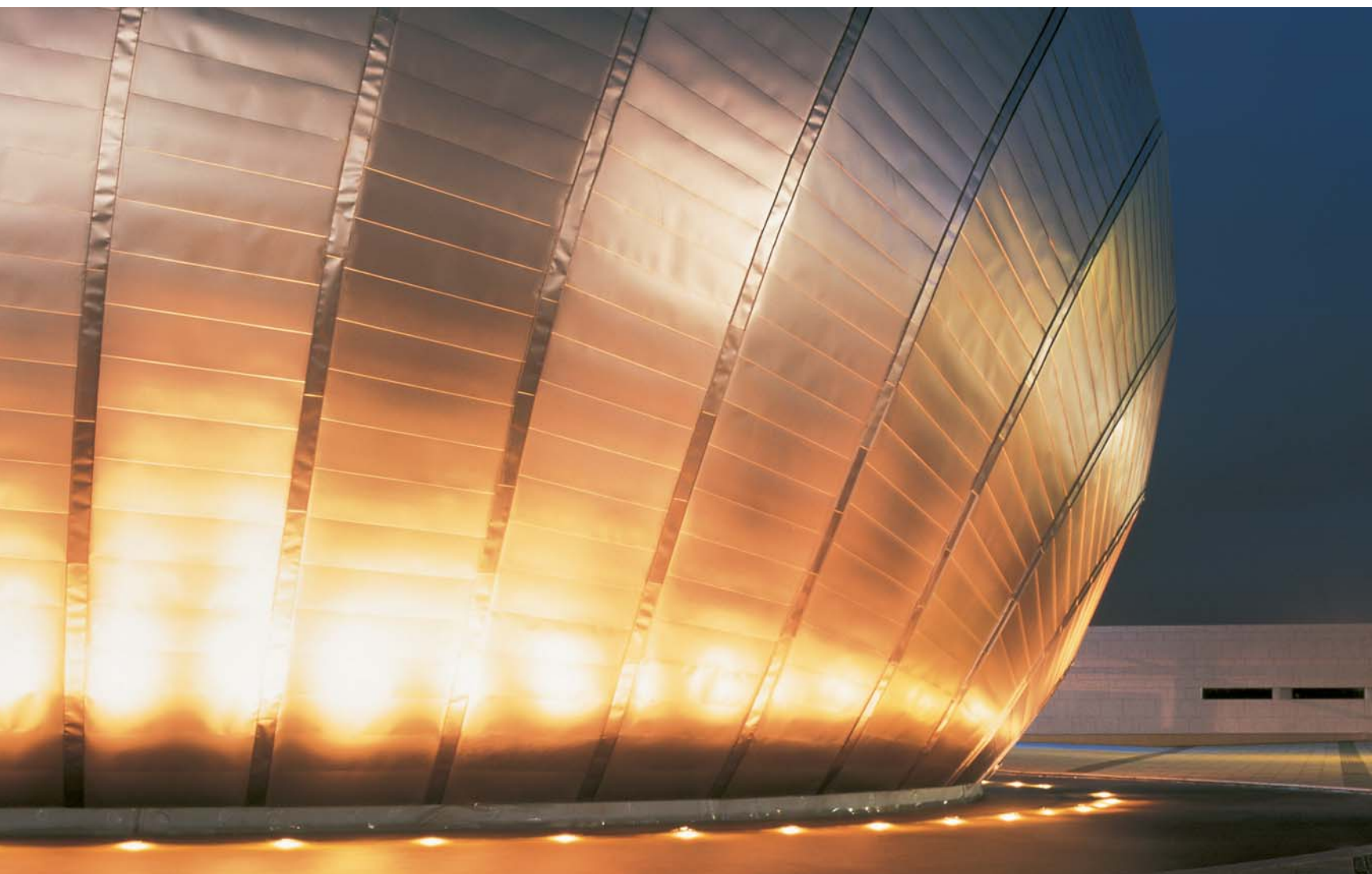

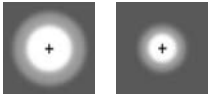

[M] [EE]

[M] Medium beam distribution, symmetric
 [EE] Very narrow beam distribution, symmetric



[M]	Part ID	Light source	K	lm*	cd/klm	C ₀ C ₁₈₀	kg
ULC210**	139-1678	1 LED 2W / 24V AC/DC	3000	200	2119	16°/16°	1.1
	139-1686	3 LED 3W / 24V AC/DC	3000	404	1552	21°/21°	1.1
ULC230	139-1634	12 LED 24W / 230V	3000	2951	2196	16°/16°	5.8

[EE]	Part ID	Light source	K	lm*	cd/klm	C ₀ C ₁₈₀	kg
ULC210**	139-1688	3 LED 3W / 24V AC/DC	3000	404	7076	7°/7°	1.1
ULC230	139-1768	12 LED 24W / 230V	3000	2951	7191	7°/7°	5.8

** Electronic converter required. To be ordered separately.

ULC210

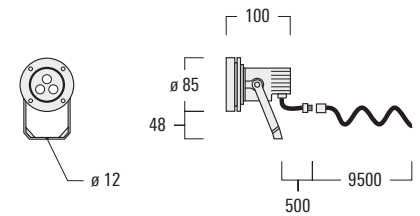

ULC230

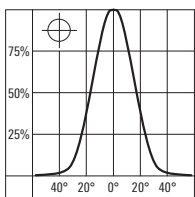
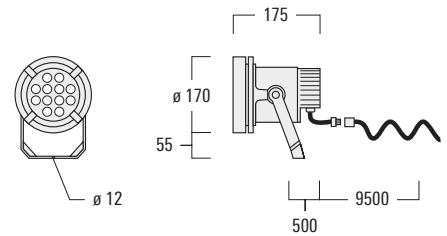

[M]

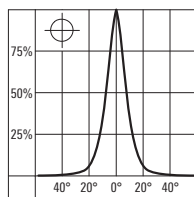

[EE]

* Nominal lumen output based on LED manufacturers data at 85°C T_J. For rated lumens at 25°C T_q and latest data refer to www.we-ef.com.

ELECTRICAL ACCESSORIES

Mains converter (230V / 24V)

IP20, Class I. Mounting to 35 mm rail.

			A	B	C
for ULC210	400-0310	TVE-DC 24 V/12 W	90	61	18
	400-0311	TVE-DC 24 V/60 W	89	59	72

Magnetic transformer (230V / 24V)

IP65, Class II.

			A	B	C
for ULC210	185-2884	TVM-AC 24 V/20 W	137	63	120
	185-2885	TVM-AC 24 V/50 W	137	63	120

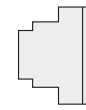

B

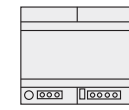

C

A

Mains converter

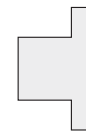

B

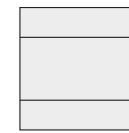

C

A

Magnetic transformer

OPTICAL ACCESSORIES

Internal Optical Accessories

	IO-360 Flood lens	IO-180 Linear spread lens
for ULC210	139-0837	139-0836
for ULC230	139-1115	139-1114

Color filter or colored LEDs on request



Veolia. Caluire (F). Lighting design: Pierre-Philippe Garde, Cobalt.

IOS® Beam distributions for inground luminaires

[B] wide beam, symmetric
[M] medium beam, symmetric
[EE] very narrow beam, symmetric
[EES] very narrow beam, symmetric, 'sharp cut-off'
[A20] wallwash, asymmetric

[LB] linear, wide beam, symmetric
[LM] linear, medium beam, symmetric
[LE] linear, narrow beam, symmetric
[LEE] linear, very narrow beam, symmetric
[LA10] linear, wallwash, asymmetric

[LA6] linear, wallwash, asymmetric
[LA20] linear, wallwash, asymmetric

[] controlled, single or double sided
[] diffused

Inground luminaires



EFC100 LED 20



ESC100 LED 22



ETC100 LED 24

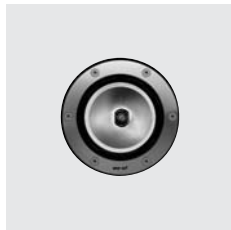

ETC100 28



ETC100 Gimbal LED 30



ETC100 Gimbal 32

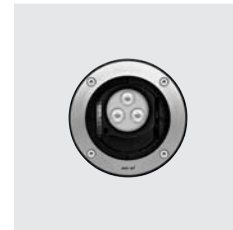

ETC300 Gimbal LED 34



ETC300 LED 36

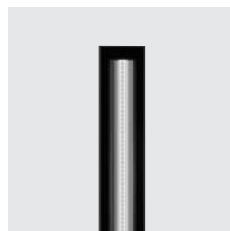

ETV100 LED 38



ETR100 LED 42



ETR100 44



ACCESSORIES

- Mounting 48
- Electrical 50
- Optical 52

EFC100 SERIES

Inground luminaire, controlled single or double sided distribution.

IP67, Class I. IK09. Stainless steel inground section. Die-cast dome made from marine-grade aluminium alloy. 5CE superior corrosion protection including PCS hardware. Powdercoat finish in RAL 9004, RAL 9006, RAL 9007 or RAL 9016. Silicone rubber gasket. Optical lens made from PMMA. Factory-sealed termination chamber complete with cable gland and 1.5 m of flexible PVC free cable. IP68 in-line connector facilitates easy removal for off-site lamp replacement.

'No tool' removable gear tray assembly. Integral EC electronic converter.

Factory installed LED circuit board. LED boards can be easily removed for upgrading. PMMA LED lens.

Luminaire requires installation blockout which is included.

Luminaire can be driven over at low speeds only. It is not designed for normal traffic conditions. Luminaire can be damaged under such conditions as breaking, accelerating or turning.

Light source

LED 6-12 W, 3000 K,
for 4000 K refer to www.we-ef.com

Accessories

■ Electrical, page 50



Pier seaside Heiligendamm (D). Lighting design: Institut für Gebäude + Energie + Licht Planung, Prof. Dr.-Ing. Thomas Römhild, Wismar.



Controlled distribution, single or double sided



single sided	Part ID	Light source	K	lm*	Factor***	°C**	kg
EFC120	185-2526	6 LED 6W / 350 mA	3000	807	1.00	45	5.1

double sided	Part ID	Light source	K	lm*	Factor***	°C**	kg
EFC120	185-2559	2 x 6 LED 12W / 350 mA	3000	1614	1.00	51	5.1

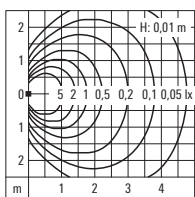
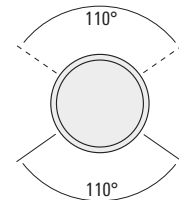
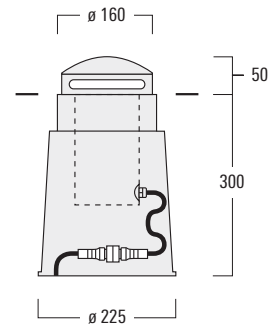

single sided

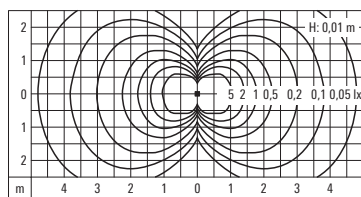

double sided

* Nominal lumen output based on LED manufacturers data at 85°C T_J. For rated lumens at 25°C T_q and latest data refer to www.we-ef.com.

** Operational surface temperature, based on ground temperature of 15°C

*** Multiplier for Isolux value

ESC100 SERIES

Inground luminaire, medium, very narrow or very narrow beam distribution 'sharp cut-off', symmetric.

IP67, Class I. IK07. Stainless steel construction inground section. Die-cast hood with 30° angle made from marine-grade aluminium alloy avoids glare to passers-by and helps prevent accumulation of insects, leaves and debris on the lens. 5CE superior corrosion protection including PCS hardware. Powdercoat finish in RAL 9004, RAL 9006, RAL 9007 or RAL 9016. Factory-sealed termination chamber complete with cable gland including spiral cable bending protection and 1.5 m of flexible PVC free cable.

Integral EC electronic converter. Factory installed LED circuit board. LED boards can be easily removed for upgrading. PMMA LED lens array.

The optional installation blackout is recommended for mounting. To be ordered separately.

Light source
LED 18-24 W, 3000 K,
for 4000 K refer to www.we-ef.com

Light distributions
[M] [EE] [EES]

Accessories
■ Mounting, page 48



RMIT University, Bowen Lane. Melbourne (AUS). Lighting design & Landscape architect: RMIT

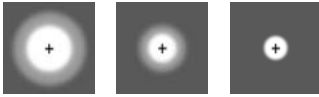

[M] [EE] [EES]

[M] Medium beam distribution, symmetric
 [EE] Very narrow beam distribution, symmetric
 [EES] Very narrow beam distribution, symmetric, 'sharp cut-off'



[M]	Part ID	Light source	K	lm*	cd/klm	C ₀ C ₁₈₀	°C**	kg
ESC130	185-3077	12 LED 18W / 500 mA	3000	2217	2378	13°/17°	26	7.9
ESC140	185-3003	24 LED 24W / 350 mA	3000	3228	2378	13°/17°	30	10.4

[EE]	Part ID	Light source	K	lm*	cd/klm	C ₀ C ₁₈₀	°C**	kg
ESC130	185-3079	12 LED 18W / 500 mA	3000	2217	7672	7°/8°	26	7.9
ESC140	185-3084	24 LED 24W / 350 mA	3000	3228	7672	7°/8°	30	10.4

[EES]	Part ID	Light source	K	lm*	cd/klm	C ₀ C ₁₈₀	°C**	kg
ESC130	185-3081	12 LED 18W / 500 mA	3000	2217	17197	4°/6°	26	7.9
ESC140	185-3086	24 LED 24W / 350 mA	3000	3228	17197	4°/6°	30	10.4

ESC130

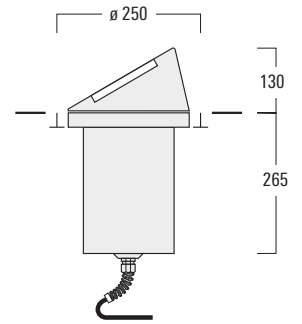

ESC140

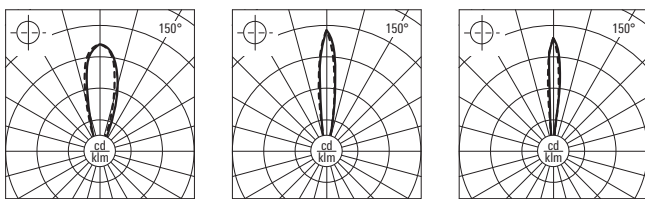
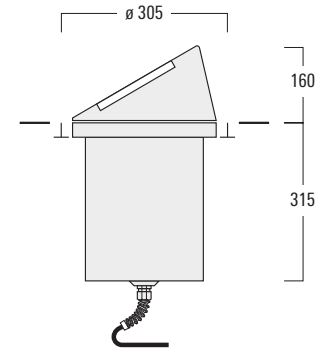

[M] [EE] [EES]

* Nominal lumen output based on LED manufacturers data at 85°C T_J. For rated lumens at 25°C T_q and latest data refer to www.we-ef.com.
 ** Operational surface temperature, based on ground temperature of 15°C

ETC100 SERIES

Inground luminaire, diffused distribution.

ETC109: IP68 (up to 10 m), Class III. IK09.

ETC119: IP67, Class III. IK09.

Stainless steel construction including PCS hardware. Silicone rubber gasket. Safety glass lens; max. load 5 tonnes. Luminaire can be driven over at low speed. Factory-sealed termination chamber complete with cable gland and 1.5 m of flexible PVC free cable. IP68 in-line connector facilitates easy removal for off-site lamp replacement.

Factory installed LED circuit board in either white, red, green, blue or RGB. LED boards can be easily removed for upgrading.

Luminaire requires installation blockout. To be ordered separately.

Electronic converter required. To be ordered separately.

Light source

LED 0.5-1.5 W

Accessories

■ Mounting, page 48

■ Electrical, page 50

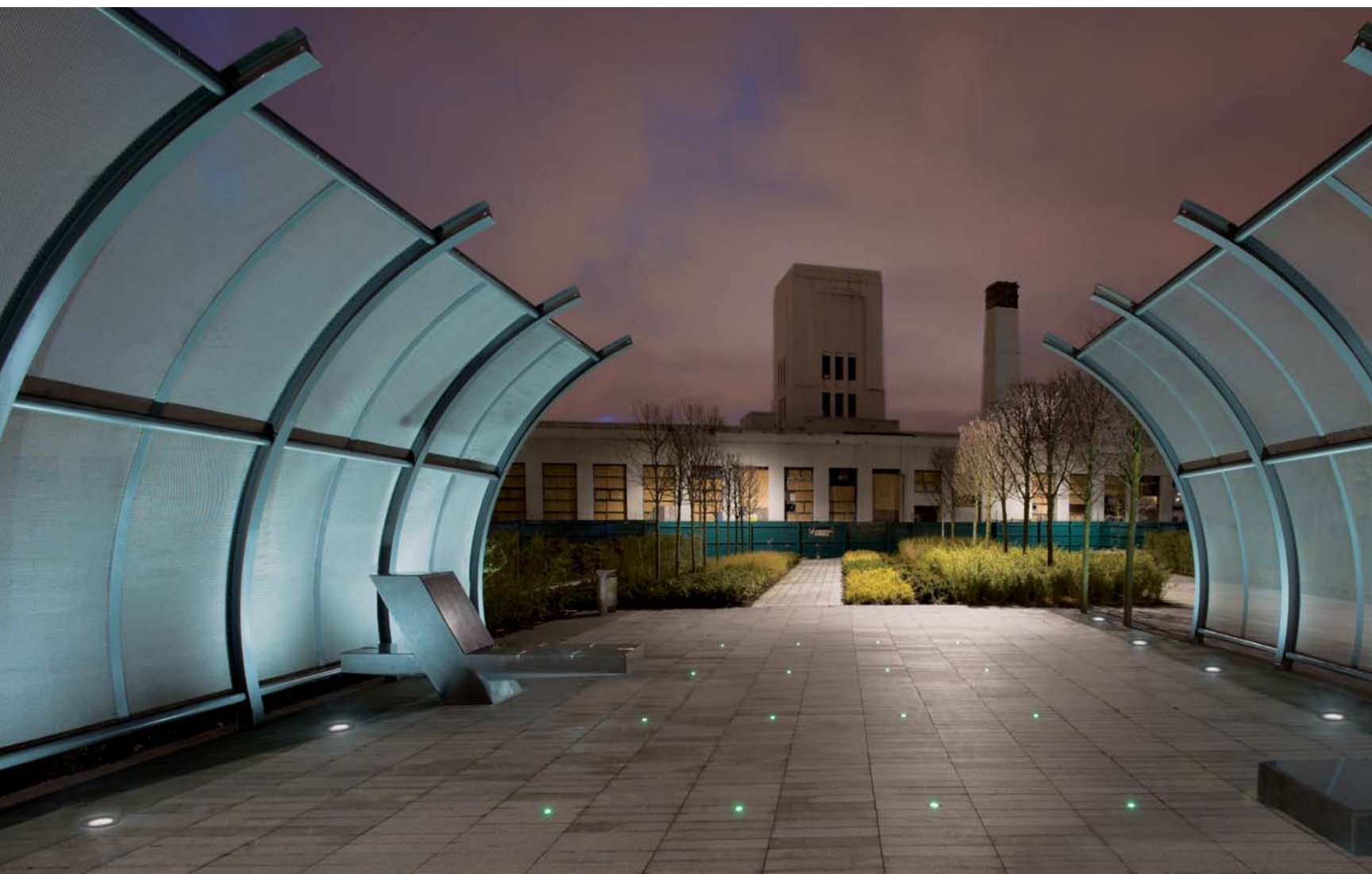

Liverpool Innovation Park. Liverpool (UK). Landscape architect: Scott Wilson Landscape Architects, Manchester.



	Part ID	Light source		lm*	Lm [cd/m ²]	kg
ETC109	185-1557	4 LED 0.5W / 12V DC	white	13	3787	0.5
	185-1558	4 LED 0.5W / 12V DC	red	18	4951	0.5
	185-1559	4 LED 0.5W / 12V DC	green	15	2759	0.5
	185-1560	4 LED 0.5W / 12V DC	blue	4	1416	0.5
	185-1562	3 x 4 LED 1.5W / 12V DC	red-green-blue	24	3854	0.5
ETC119	185-2843	1 LED 1W / 24V AC/DC	white	80	3019	1.0

ETC109

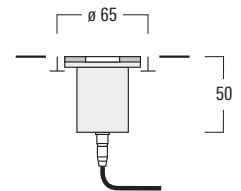

ETC119

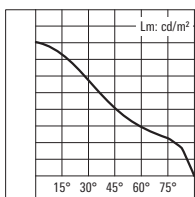
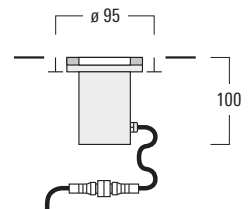

* Based on CIE illuminant D65

ETC100 SERIES

Inground luminaire, medium, very narrow or very narrow beam distribution
'sharp cut-off', symmetric.

IP67, Class III. IK09. Stainless steel construction including PCS hardware. Silicone rubber gasket. Safety glass lens; max. load 5 tonnes. Luminaire can be driven over at low speed. Factory-sealed termination chamber complete with cable gland and 1.5 m of flexible PVC free cable. IP68 in-line connector facilitates easy removal for off-site lamp replacement.

Factory installed LED circuit board. LED boards can be easily removed for upgrading. PMMA LED lens array.

The optional installation blackout is recommended for mounting.
To be ordered separately.

Electronic converter required. To be ordered separately.

Light source
LED 2-3 W, 3000 K,
for 4000 K refer to www.we-ef.com

Light distributions
[M] [EE] [EES]

Accessories
■ Mounting, page 48
■ Electrical, page 50



Coal mine Zollverein. Essen (D). Lighting design: Licht Kunst Licht AG. Landscape architect: Planergruppe GmbH Oberhausen.



[M] [EE] [EES]

[M] Medium beam distribution, symmetric

[EE] Very narrow beam distribution, symmetric

[EES] Very narrow beam distribution, symmetric, 'sharp cut-off'



[M]	Part ID	Light source	K	lm*	cd/klm	C ₀ C ₁₈₀	°C**	kg
ETC110	185-2770	1 LED 2W / 24V AC/DC	3000	200	2119	16°/16°	23	1.1
	185-2777	3 LED 3W / 24V AC/DC	3000	404	1552	21°/21°	28	1.1
[EE]	Part ID	Light source	K	lm*	cd/klm	C ₀ C ₁₈₀	°C**	kg
ETC110	185-2778	3 LED 3W / 24V AC/DC	3000	404	7076	7°/7°	28	1.1
[EES]	Part ID	Light source	K	lm*	cd/klm	C ₀ C ₁₈₀	°C**	kg
ETC110	185-2772	1 LED 2W / 24V AC/DC	3000	200	29000	4°/4°	23	1.1
	185-2779	3 LED 3W / 24V AC/DC	3000	404	11915	6°/6°	28	1.1

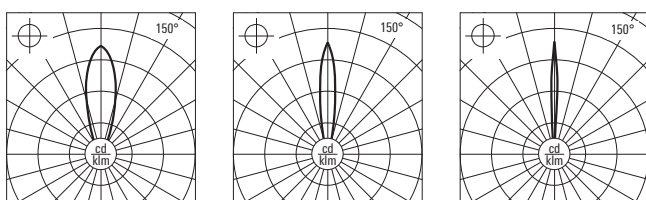
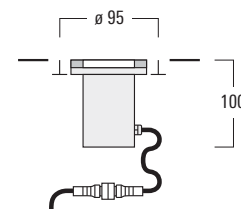

[M] [EE] [EES]

* Nominal lumen output based on LED manufacturers data at 85°C T_J. For rated lumens at 25°C T_q and latest data refer to www.we-ef.com.

** Operational surface temperature, based on ground temperature of 15°C

ETC100 SERIES

Inground luminaire, medium or very narrow beam distribution, symmetric.

IP67, Class I, IK10+. Stainless steel construction including PCS hardware. Silicone rubber gasket. Safety glass lens; max. load 5 tonnes. Luminaire can be driven over at low speed. Factory-sealed termination chamber complete with cable gland and 1.5 m of flexible PVC free cable. Cable gland with spiral cable bending protection.

Integral HPF or ECG control gear. 'No tool' removable gear/reflector tray. Anodised aluminium reflector.

The optional installation blockout is recommended for mounting. Option with Anti-Slip ceramic Coating ASC to DIN 51130 (Trip Classification 10) available on request.

The optional CTA® Cool Touch Adaptor provides significant reduction in glass surface temperature.

Light source
HIT 20-250 W

Light distributions
[M] [EE]

Accessories

- Mounting, page 48
- Electrical, page 50
- Optical, page 52



Eleanor and Wilson Greatbatch Pavilion. Buffalo (USA). Architect: Toshiko Mori Architect, PLLC. Lighting design: ARUP Lighting.



[M] [EE]

[M] Medium beam distribution, symmetric
 [EE] Very narrow beam distribution, symmetric



[M]	Part ID	Light source	lm	cd/klm	C ₀ C ₁₈₀	°C*	kg
ETC120	185-1528 [ECG]	HIT-TC-CE 20W PGJ5	1650	2226	14°/14°	74	2.1
ETC130	185-1576 [ECG]	HIT-CE 35W G12	3600	2261	12°/12°	71/57	6.8
ETC140	185-1577 [ECG]	HIT-CE 70W G12	7300	1378	19°/19°	86/69	8.8
	185-2354 [HPF]	HIT-CE 100W G12	9500	1489	19°/19°	100/84	10.0
	185-0749 [HPF]	HIT-CE 150W G12	15000	1215	20°/20°	118/99	10.2
ETC150	185-1579 [ECG]	HIT-CE 150W G12	15000	2104	13°/13°	99/71	19.0
	185-1584 [HPF]	HIT-CE 250W G12	23000	1622	18°/18°	116/95	21.0

[EE]	Part ID	Light source	lm	cd/klm	C ₀ C ₁₈₀	°C*	kg
ETC120	185-1483 [ECG]	HIT-TC-CE 20W PGJ5	1650	15648	3°/3°	80	2.1
ETC130	185-1588 [ECG]	HIT-CE 35W G12	3600	19636	3°/3°	70/58	6.8
ETC140	185-1589 [ECG]	HIT-CE 70W G12	7300	33186	3°/3°	78/60	8.8
	185-2360 [HPF]	HIT-CE 100W G12	9500	22734	3°/3°	99/80	10.0
	185-0757 [HPF]	HIT-CE 150W G12	15000	15818	4°/4°	115/90	10.2
ETC150	185-1591 [ECG]	HIT-CE 150W G12	15000	30080	3°/3°	87/68	19.0
	185-1596 [HPF]	HIT-CE 250W G12	23000	15085	4°/4°	103/82	21.0

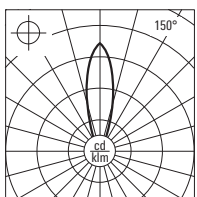

[M]

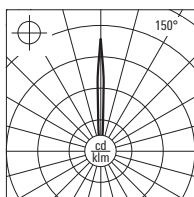

[EE]

ETC120

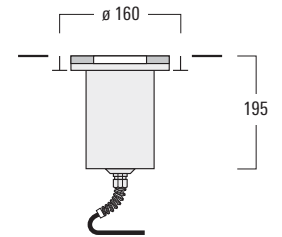

ETC130

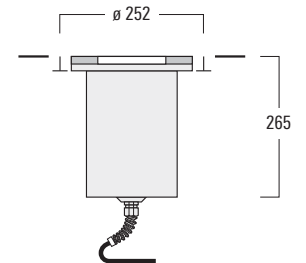

ETC140

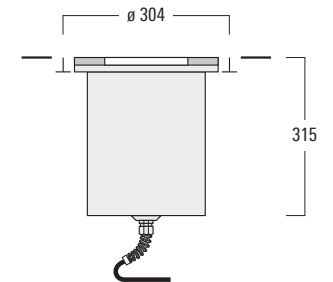

ETC150

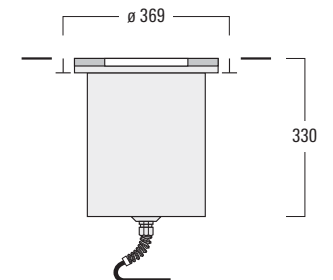

* Operational surface temperature, based on ground temperature of 15°C (without CTA® / with CTA®)

ETC100 GIMBAL SERIES

Inground luminaire, wide, medium, very narrow or very narrow beam distribution 'sharp cut-off', symmetric or wallwash distribution, asymmetric. Tilt and rotatable.

IP67, Class I. IK10+. Stainless steel construction including PCS hardware. Silicone rubber gasket. Safety glass lens; max. load 5 tonnes. Luminaire can be driven over at low speed. Factory-sealed termination chamber complete with cable gland and 1.5 m of flexible PVC free cable. Cable gland with spiral cable bending protection.

For reduced depth (ETC300 series), see page 34.

Integral EC electronic converter. 'No tool' removable gear/lens tray. Gimbal mounted, 355°/360° rotatable and 20°/30° tilt.

Factory installed LED circuit board. LED boards can be easily removed for upgrading. PMMA LED lens array.

The optional installation blockout is recommended for mounting. To be ordered separately.

Option with Anti-Slip ceramic Coating ASC to DIN 51130 (Trip Classification 10) available on request.

Light source

LED 6-24 W, 3000 K,
for 4000 K refer to www.we-ef.com

Light distributions

[B] [M] [EE] [EES] [A20]

Accessories

- Mounting, page 48
- Electrical, page 50
- Optical, page 52



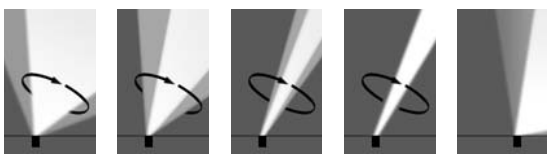

- [B] Wide beam distribution, symmetric
- [M] Medium beam distribution, symmetric
- [EE] Very narrow beam distribution, symmetric
- [EES] Very narrow beam distribution, symmetric, 'sharp cut-off'
- [A20] Wallwash distribution, asymmetric



[B]	Part ID	Light source	K	lm*	cd/klm	C ₀ C ₁₈₀	°C**	kg
ETC130-GB	185-2658	12 LED 18W / 500 mA	3000	2217	952	25°/25°	34	6.2
ETC140-GB	185-2723	24 LED 24W / 350 mA	3000	3228	1081	24°/24°	31	10.6

[M]	Part ID	Light source	K	lm*	cd/klm	C ₀ C ₁₈₀	°C**	kg
ETC120-GB	185-7592	3 LED 6W / 700 mA	3000	738	1633	21°/21°	25	3.8
ETC130-GB	185-2446	12 LED 18W / 500 mA	3000	2217	2339	17°/17°	34	6.2
ETC140-GB	185-2600	24 LED 24W / 350 mA	3000	3228	2175	17°/17°	31	10.6

[EE]	Part ID	Light source	K	lm*	cd/klm	C ₀ C ₁₈₀	°C**	kg
ETC120-GB	185-7593	3 LED 6W / 700 mA	3000	738	7530	7°/7°	25	3.8
ETC130-GB	185-2661	12 LED 18W / 500 mA	3000	2217	6728	8°/8°	34	6.2
ETC140-GB	185-2726	24 LED 24W / 350 mA	3000	3228	7418	7°/7°	31	10.6

[EES]	Part ID	Light source	K	lm*	cd/klm	C ₀ C ₁₈₀	°C**	kg
ETC120-GB	185-7682	3 LED 6W / 700 mA	3000	738	16462	5°/5°	25	3.8
ETC130-GB	185-2591	12 LED 18W / 500 mA	3000	2217	18322	5°/5°	34	6.2
ETC140-GB	185-2603	24 LED 24W / 350 mA	3000	3228	21083	5°/5°	31	10.6

[A20]	Part ID	Light source	K	lm*	cd/klm	C ₀ C ₁₈₀	C ₉₀ C ₂₇₀	°C**	kg
ETC130-GB	185-3091	12 LED 18W / 500 mA	3000	2217	798	15°/17°	34°/34°	34	6.2
ETC140-GB	185-3093	24 LED 24W / 350 mA	3000	3228	660	18°/23°	33°/33°	31	10.6

ETC120-GB

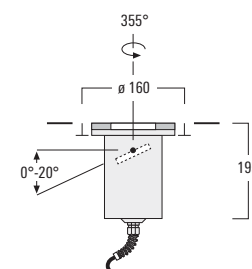

ETC130-GB

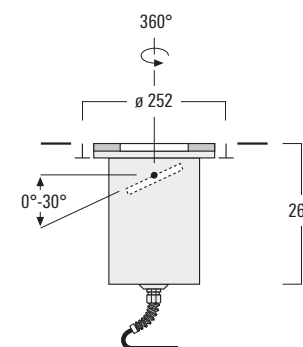

ETC140-GB

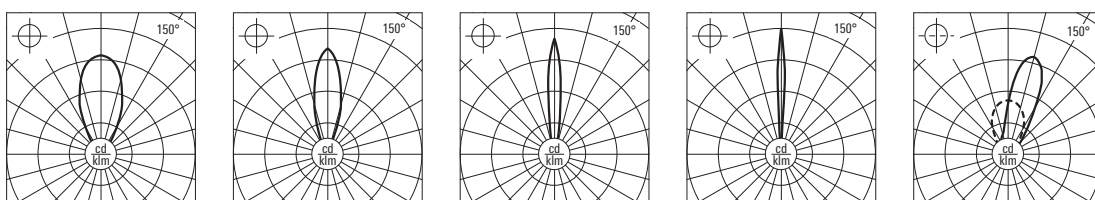
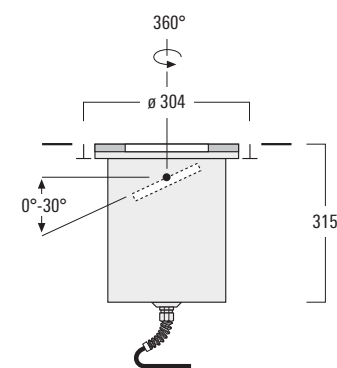

[B] [M] [EE] [EES] [A20]

* Nominal lumen output based on LED manufacturers data at 85°C T_J. For rated lumens at 25°C T_a and latest data refer to www.we-ef.com.
 ** Operational surface temperature, based on ground temperature of 15°C

ETC100 GIMBAL SERIES

Inground luminaire, medium or very narrow beam distribution, symmetric. Tilt and rotatable.

IP67, Class I. IK10+. Stainless steel construction including PCS hardware. Silicone rubber gasket. Safety glass lens; max. load 5 tonnes. Luminaire can be driven over at low speed. Factory-sealed termination chamber complete with cable gland and 1.5 m of flexible PVC free cable. Cable gland with spiral cable bending protection.

Integral ECG control gear. 'No tool' removable gear/reflector tray. Anodised aluminium reflector, gimbal mounted, 360° rotatable and 30° tilt. Integral Cool Touch Adaptor CTA® for reducing glass surface temperature.

The optional installation blackout is recommended for mounting. To be ordered separately. Option with Anti-Slip ceramic Coating ASC to DIN 51130 (Trip Classification 10) available on request.

Light source
HIT 20-70 W

Light distributions
[M] [EE]

Accessories

- Mounting, page 48
- Electrical, page 50
- Optical, page 52

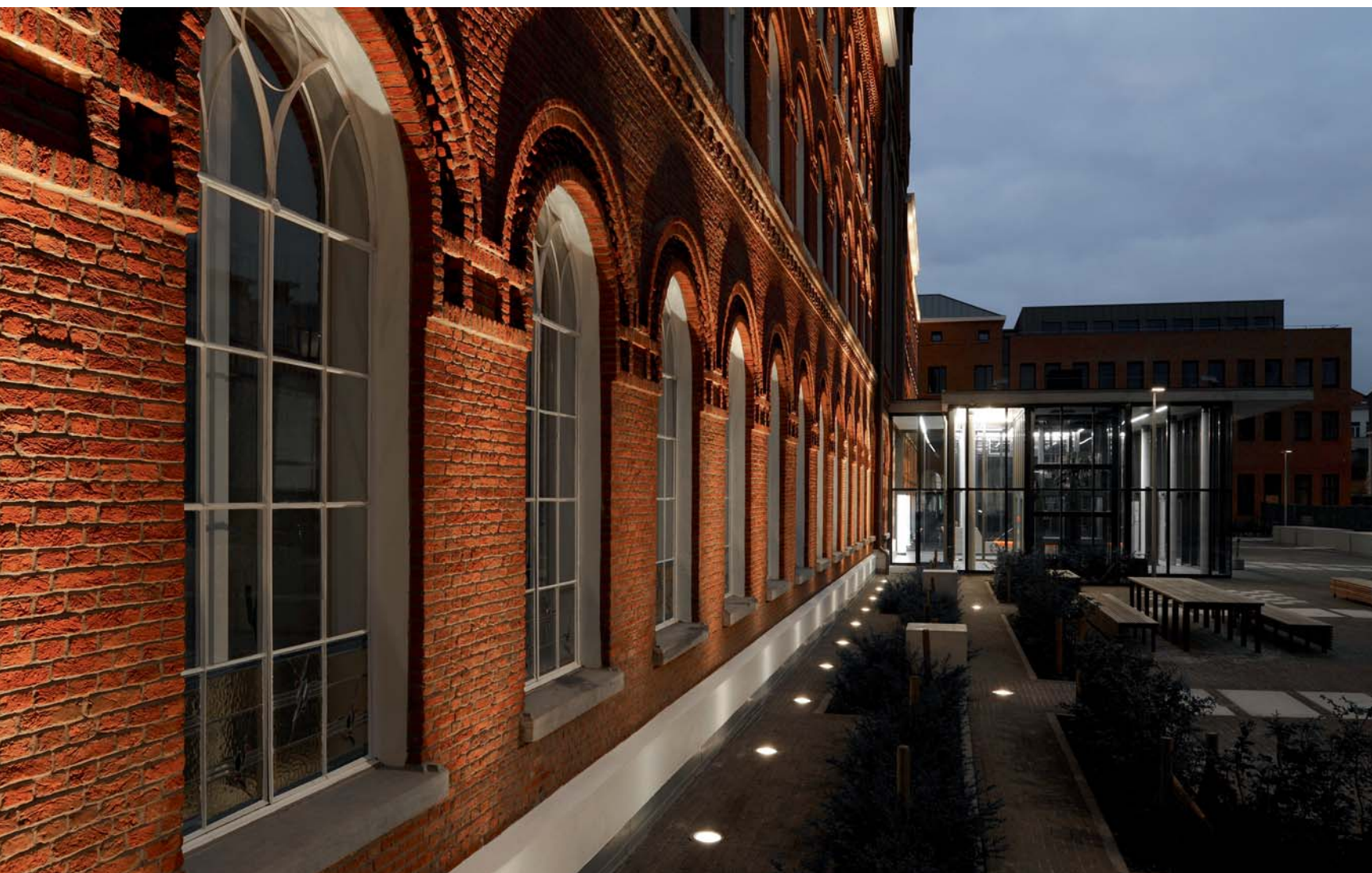

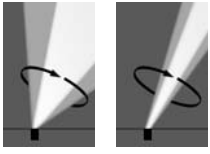

[M] [EE]

[M] Medium beam distribution, symmetric
 [EE] Very narrow beam distribution, symmetric



[M]	Part ID	Light source	lm	cd/klm	C ₀ C ₁₈₀	°C*	kg
ETC130-GB	185-2349 [ECG]	HIT-TC-CE 20W PGJ5	1650	964	16°/16°	48	6.1
	185-2350 [ECG]	HIT-TC-CE 35W PGJ5	3000	1314	16°/16°	72	6.1
ETC140-GB	185-2441 [ECG]	HIT-CE 35W G12	3600	2128	9°/9°	51	11.1
	185-2400 [ECG]	HIT-CE 70W G12	7300	2110	10°/10°	75	11.1

[EE]	Part ID	Light source	lm	cd/klm	C ₀ C ₁₈₀	°C*	kg
ETC130-GB	185-2351 [ECG]	HIT-TC-CE 20W PGJ5	1650	9818	3°/3°	53	6.1
	185-2352 [ECG]	HIT-TC-CE 35W PGJ5	3000	4708	5°/5°	79	6.1
ETC140-GB	185-2443 [ECG]	HIT-CE 35W G12	3600	13440	3°/3°	53	11.1
	185-2402 [ECG]	HIT-CE 70W G12	7300	12636	3°/3°	75	11.1

ETC130-GB

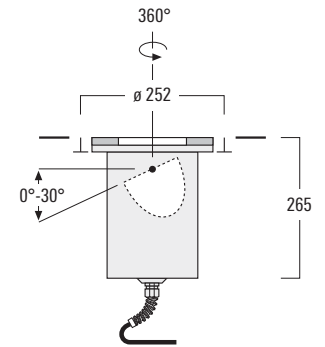

ETC140-GB

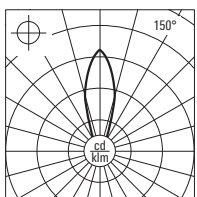
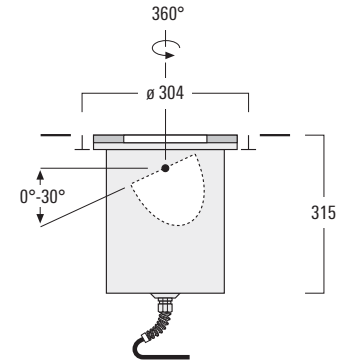

[M]

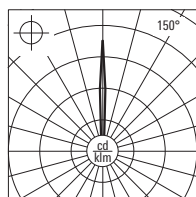

[EE]

* Operational surface temperature, based on ground temperature of 15°C

ETC300 GIMBAL SERIES

Inground luminaire, wide, medium, very narrow or very narrow beam distribution 'sharp cut-off', symmetric or wallwash distribution, asymmetric. Tilt and rotatable.

IP67, Class I. IK10+. Stainless steel construction including PCS hardware. Silicone rubber gasket. Safety glass lens; max. load 5 tonnes. Luminaire can be driven over at low speed. Factory-sealed termination chamber complete with cable gland and 1.5 m of flexible PVC free cable.

Integral EC electronic converter. 'No tool' removable gear/lens tray. Gimbal mounted, 360° rotatable and 30° tilt.

Factory installed LED circuit board. LED boards can be easily removed for upgrading. PMMA LED lens array.

The optional installation blockout is recommended for mounting. To be ordered separately.

Option with Anti-Slip ceramic Coating ASC to DIN 51130 (Trip Classification 10) available on request.

Light source

LED 12 W, 3000 K,
for 4000 K refer to www.we-ef.com



Light distributions

[B] [M] [EE] [EES] [A20]

Accessories

- Mounting, page 48
- Electrical, page 50
- Optical, page 52

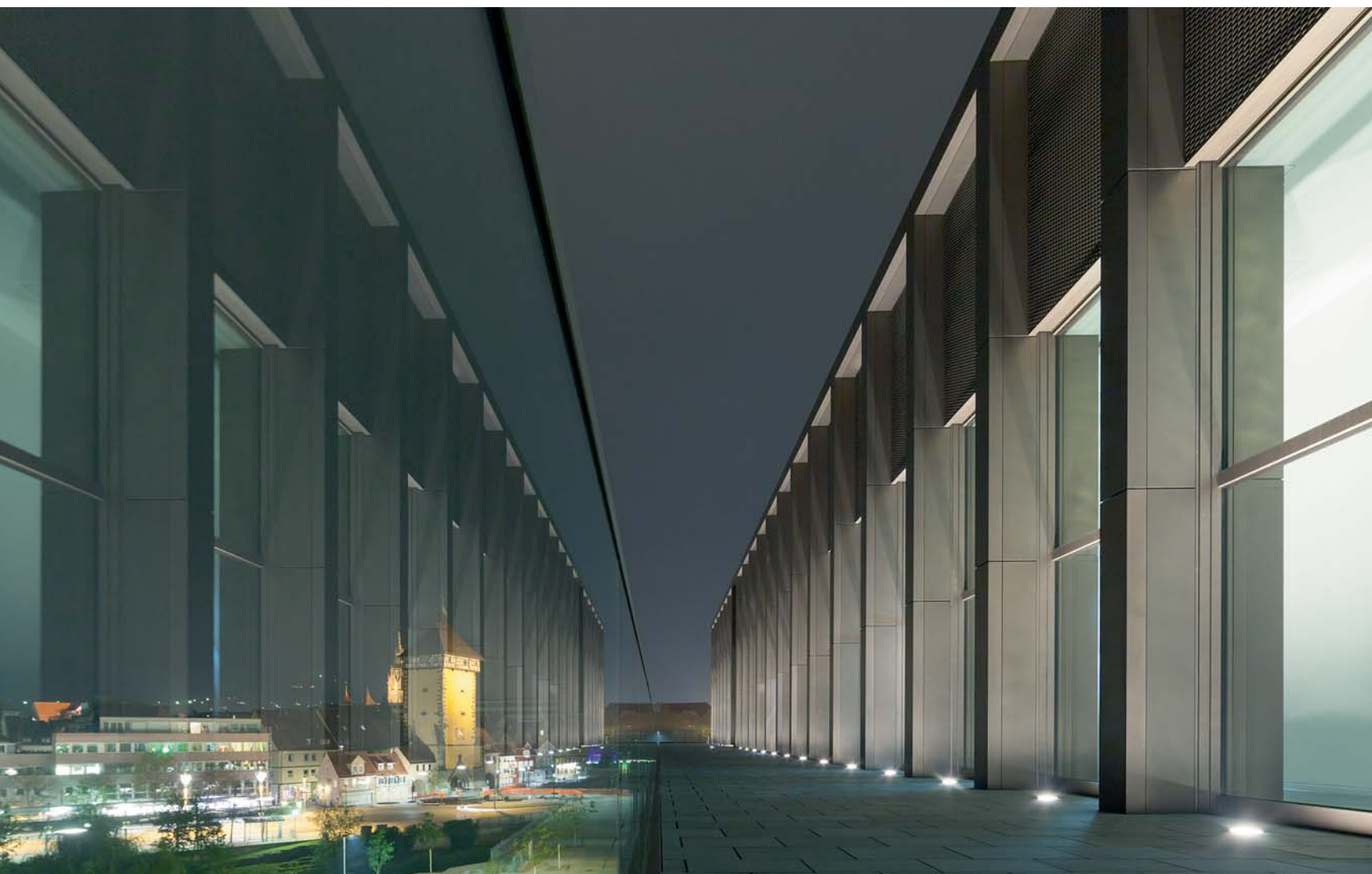

Town hall. Reutlingen (D). Architect: Max Dudler, Berlin. Lighting design: Kardorff Ingenieure, Berlin.

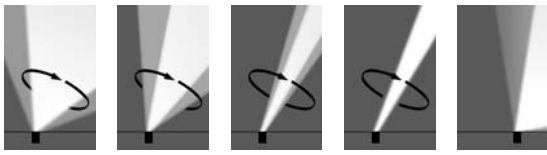

- [B] Wide beam distribution, symmetric
- [M] Medium beam distribution, symmetric
- [EE] Very narrow beam distribution, symmetric
- [EES] Very narrow beam distribution, symmetric, 'sharp cut-off'
- [A20] Wallwash distribution, asymmetric



[B]	Part ID	Light source	K	lm*	cd/klm	C ₀ C ₁₈₀	°C**	kg	
ETC330-GB	185-2688	12 LED 12W / 350 mA	3000	1614	952	25°/25°	28	5.5	
[M]	Part ID	Light source	K	lm*	cd/klm	C ₀ C ₁₈₀	°C**	kg	
ETC330-GB	185-2576	12 LED 12W / 350 mA	3000	1614	2339	17°/17°	28	5.5	
[EE]	Part ID	Light source	K	lm*	cd/klm	C ₀ C ₁₈₀	°C**	kg	
ETC330-GB	185-2691	12 LED 12W / 350 mA	3000	1614	6728	8°/8°	28	5.5	
[EES]	Part ID	Light source	K	lm*	cd/klm	C ₀ C ₁₈₀	°C**	kg	
ETC330-GB	185-2583	12 LED 12W / 350 mA	3000	1614	18322	5°/5°	28	5.5	
[A20]	Part ID	Light source	K	lm*	cd/klm	C ₀ C ₁₈₀	C ₉₀ C ₂₇₀	°C**	kg
ETC330-GB	185-3095	12 LED 12W / 350 mA	3000	1614	798	15°/17°	34°/34°	28	5.5

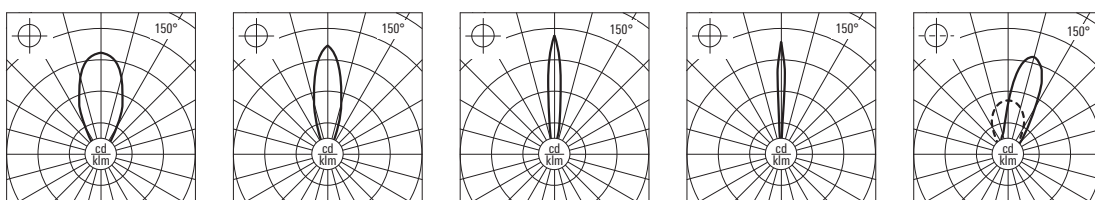
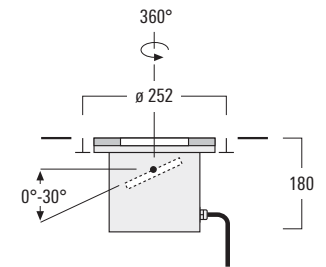

[B] [M] [EE] [EES] [A20]

* Nominal lumen output based on LED manufacturers data at 85°C T_J. For rated lumens at 25°C T_q and latest data refer to www.we-ef.com.
 ** Operational surface temperature, based on ground temperature of 15°C

ETC300 SERIES

Inground luminaire, diffused distribution.

IP67, Class I. IK10+. Stainless steel construction including PCS hardware. Silicone rubber gasket. Safety glass lens; max. load 5 tonnes. Luminaire can be driven over at low speed. Factory-sealed termination chamber complete with cable gland and 1.5 m of flexible PVC free cable. Cable gland with spiral cable bending protection (ETC329).

'No tool' removable gear tray. Integral EC electronic converter.

Factory installed LED circuit board. LED boards can be easily removed for upgrading.

The optional installation blockout is recommended for mounting. To be ordered separately.

Option with Anti-Slip ceramic Coating ASC to DIN 51130 (Trip Classification 10) available on request.

Light source

LED 5.5-15.5 W, 3000 K,
for 4000 K refer to www.we-ef.com

Accessories

■ Mounting, page 48

■ Electrical, page 50



Technical college. Wildau/Berlin (D). Architect: Anderhalten Architekten, Berlin. Lighting design: Ritter Lichttechnik Berlin.



	Part ID	Light source		lm*	cd/klm	C_0C_{180}	°C**	kg
ETC329	185-2908	LED 5.5W / 250 mA	white	705	51	56°/56°	27	2.5
ETC339	185-2909	LED 15.5W / 350 mA	white	2180	47	56°/56°	30	6.0

ETC329

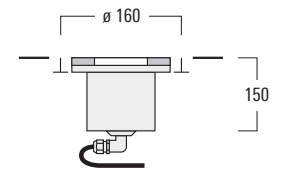

ETC339

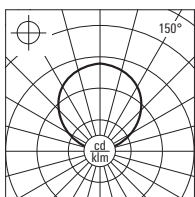
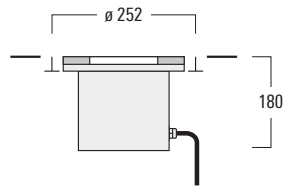

* Nominal lumen output based on LED manufacturers data at 85°C T_J. For rated lumens at 25°C T_q and latest data refer to www.we-ef.com.
 ** Operational surface temperature, based on ground temperature of 15°C

ETV100 SERIES

Inground luminaire, linear, wide, medium, narrow or very narrow beam distribution, symmetric or wallwash distribution, asymmetric.

IP67, Class I. IK08. Marine-grade all aluminium construction. Anodized aluminium extrusion. PCS hardware. Silicone rubber gasket. Safety glass lens; max. load 5 tonnes. Luminaire can be driven over at low speed. Factory-sealed termination chamber complete with cable gland and 0.5 m of flexible cable.

Linear PMMA LED lens. Factory installed LED circuit board. LED boards can be easily removed for upgrading.

Luminaire is factory sealed and does not need to be opened during installation.

The optional installation blackout is recommended for mounting. To be ordered separately.

Electronic converter with DALI or DMX (RGBW) interface.

Light source

LED 15-44 W, 3000 K,
for 4000 K refer to www.we-ef.com

Light distributions

[LB] [LM] [LE] [LEE] [LA10]

Accessories

■ Mounting, page 48



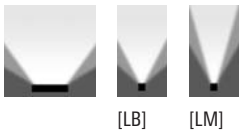

[LB] Linear, wide beam distribution, symmetric
 [LM] Linear, medium beam distribution, symmetric

[LB]	Part ID	Light source	K	lm*	cd/klm	C ₀ C ₁₈₀	C ₉₀ C ₂₇₀	°C**	kg
ETV120	186-0236	120 LED 15W	3000	2250	430	29°/29°	45°/45°	25	4.6
ETV130	186-0251	180 LED 22.5W	3000	3375	430	29°/29°	45°/45°	25	6.0
	186-0253 [DMX]	96 LED 33W RGBW	3206	430	29°/29°	45°/45°	25	6.0	
ETV140	186-0266	240 LED 30W	3000	4500	430	29°/29°	45°/45°	25	7.5
	186-0268 [DMX]	128 LED 44W RGBW	4275	430	29°/29°	45°/45°	25	7.5	

[LM]	Part ID	Light source	K	lm*	cd/klm	C ₀ C ₁₈₀	C ₉₀ C ₂₇₀	°C**	kg
ETV120	186-0239	120 LED 15W	3000	2250	827	14°/14°	49°/49°	25	4.6
ETV130	186-0254	180 LED 22.5W	3000	3375	827	14°/14°	49°/49°	25	6.0
	186-0256 [DMX]	96 LED 33W RGBW	3206	827	14°/14°	49°/49°	25	6.0	
ETV140	186-0269	240 LED 30W	3000	4500	827	14°/14°	49°/49°	25	7.5
	186-0271 [DMX]	128 LED 44W RGBW	4275	827	14°/14°	49°/49°	25	7.5	

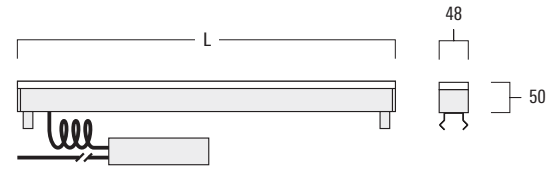

Dimensions	L
ETV120	627 mm
ETV130	927 mm
ETV140	1227 mm

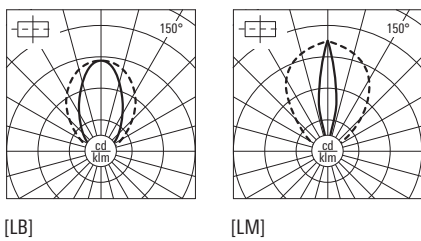

* Nominal lumen output based on LED manufacturers data at 25°C T_J. For rated lumens at 25°C T_a and latest data refer to www.we-ef.com.
 ** Operational surface temperature, based on ground temperature of 15°C

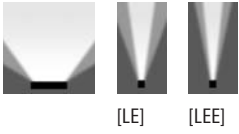

[LE] Linear, narrow beam distribution, symmetric
 [LEE] Linear, very narrow beam distribution, symmetric

[LE]	Part ID	Light source	K	lm*	cd/klm	C ₀ C ₁₈₀	C ₉₀ C ₂₇₀	°C**	kg
ETV120	186-0242	120 LED 15W	3000	2250	1097	8°/8°	42°/42°	25	4.6
ETV130	186-0257	180 LED 22.5W	3000	3375	1097	8°/8°	42°/42°	25	6.0
	186-0259 [DMX]	96 LED 33W RGBW	3206	1097	1097	8°/8°	42°/42°	25	6.0
ETV140	186-0272	240 LED 30W	3000	4500	1097	8°/8°	42°/42°	25	7.5
	186-0274 [DMX]	128 LED 44W RGBW	4275	1097	1097	8°/8°	42°/42°	25	7.5

[LEE]	Part ID	Light source	K	lm*	cd/klm	C ₀ C ₁₈₀	C ₉₀ C ₂₇₀	°C**	kg
ETV120	186-0245	120 LED 15W	3000	2250	1594	6°/6°	42°/42°	25	4.6
ETV130	186-0260	180 LED 22.5W	3000	3375	1594	6°/6°	42°/42°	25	6.0
	186-0262 [DMX]	96 LED 33W RGBW	3206	1594	1594	6°/6°	42°/42°	25	6.0
ETV140	186-0275	240 LED 30W	3000	4500	1594	6°/6°	42°/42°	25	7.5
	186-0277 [DMX]	128 LED 44W RGBW	4275	1594	1594	6°/6°	42°/42°	25	7.5

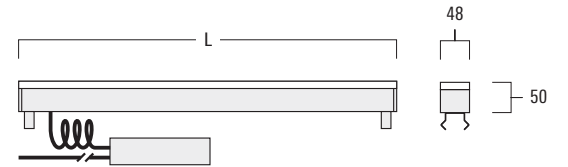

Dimensions	L
ETV120	627 mm
ETV130	927 mm
ETV140	1227 mm

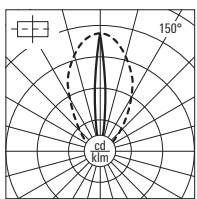

[LE]

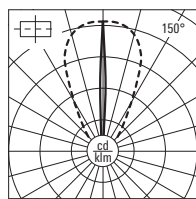

[LEE]



[LA10]

[LA10] Linear, wallwash distribution, asymmetric



[LA10]	Part ID	Light source	K	lm*	cd/klm	C ₀ C ₁₈₀	C ₉₀ C ₂₇₀	°C**	kg
ETV120	186-0248	120 LED 15W	3000	2250	959	17°/12°	43°/43°	25	4.6
ETV130	186-0263	180 LED 22.5W	3000	3375	959	17°/12°	43°/43°	25	6.0
	186-0265 [DMX]	96 LED 33W RGBW	3206	959	17°/12°	43°/43°	25	6.0	
ETV140	186-0278	240 LED 30W	3000	4500	959	17°/12°	43°/43°	25	7.5
	186-0280 [DMX]	128 LED 44W RGBW	4275	959	17°/12°	43°/43°	25	7.5	

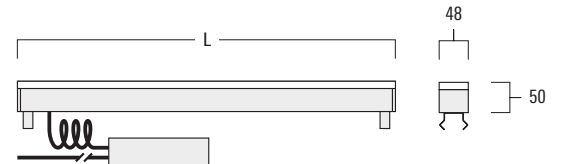

Dimensions	L
ETV120	627 mm
ETV130	927 mm
ETV140	1227 mm

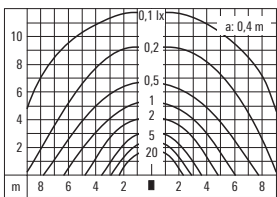

[LA10]

* Nominal lumen output based on LED manufacturers data at 25°C T_J. For rated lumens at 25°C T_q and latest data refer to www.we-ef.com.

** Operational surface temperature, based on ground temperature of 15°C

ETR100 SERIES

Inground luminaire, linear, diffused distribution.

IP67, Class I. IK10+. Die-cast body made from marine-grade aluminium alloy. Stainless steel frame including PCS hardware. Silicone rubber gasket. Factory-sealed termination chamber complete with cable gland and 1.5 m of flexible PVC free cable. IP68 in-line connector. Safety glass; max. load 5 tonnes. Luminaire can be driven over at low speed.

Integral EC electronic converter. Factory installed circuit board with LEDs in either white or RGB. Optional 1-10V or DALI interface on request.

Luminaire requires installation blackout BER. To be ordered separately. Option with Anti-Slip ceramic Coating ASC to DIN 51130 (Trip Classification 10) available on request.

Light source
LED 9-79 W

Accessories

- Mounting, page 48
- Electrical, page 50



SonyCenter. Berlin (D). Architect: Murphy/Jahn, Chicago. Lighting design: L'Observatoire International, New York.

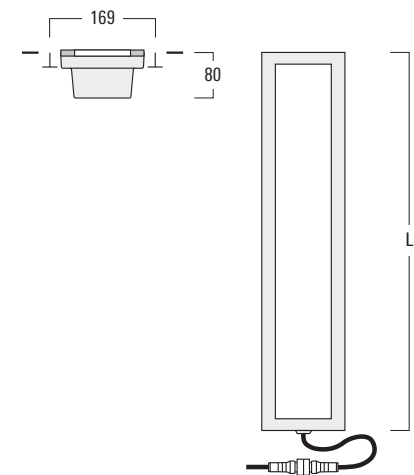

	Part ID	Light source		lm*	Lm [cd/m ²]	kg
ETR139	186-0072	72 LED 9W	white	241	644	7.6
	186-0054 [DMX]	72 LED 9W	white	241	644	7.6
	186-0059 [DMX]	3 x 72 LED 26W	red-green-blue	435	889	7.6
ETR149	186-0124	144 LED 18W	white	482	644	14.0
	186-0060 [DMX]	144 LED 18W	white	482	644	14.0
	186-0065 [DMX]	3 x 144 LED 53W	red-green-blue	870	889	14.0
ETR159	186-0082	216 LED 27W	white	723	644	20.5
	186-0066 [DMX]	216 LED 27W	white	723	644	20.5
	186-0123 [DMX]	3 x 216 LED 79W	red-green-blue	1305	889	20.5

Dimensions	L
ETR139	558 mm
ETR149	1008 mm
ETR159	1485 mm

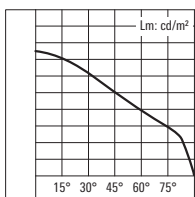

* Nominal lumen output based on LED manufacturers data at 85°C T_J. For rated lumens at 25°C T_q and latest data refer to www.we-ef.com.

ETR100 SERIES

Inground luminaire, linear, diffused distribution.

IP67, Class I, IK10+. Die-cast body made from marine-grade aluminium alloy. Stainless steel frame including PCS hardware. Silicone rubber gasket. Factory-sealed termination chamber complete with cable gland and 1.5 m of flexible PVC free cable. IP68 in-line connector. Safety glass; max. load 5 tonnes. Luminaire can be driven over at low speed.

Anodised reflector. Integral ECG control gear.

Luminaire requires installation blackout BER. To be ordered separately. Option with Anti-Slip ceramic Coating ASC to DIN 51130 (Trip Classification 10) available on request.

Light source

T5 21-39 W

Accessories

■ Mounting, page 48

■ Electrical, page 50

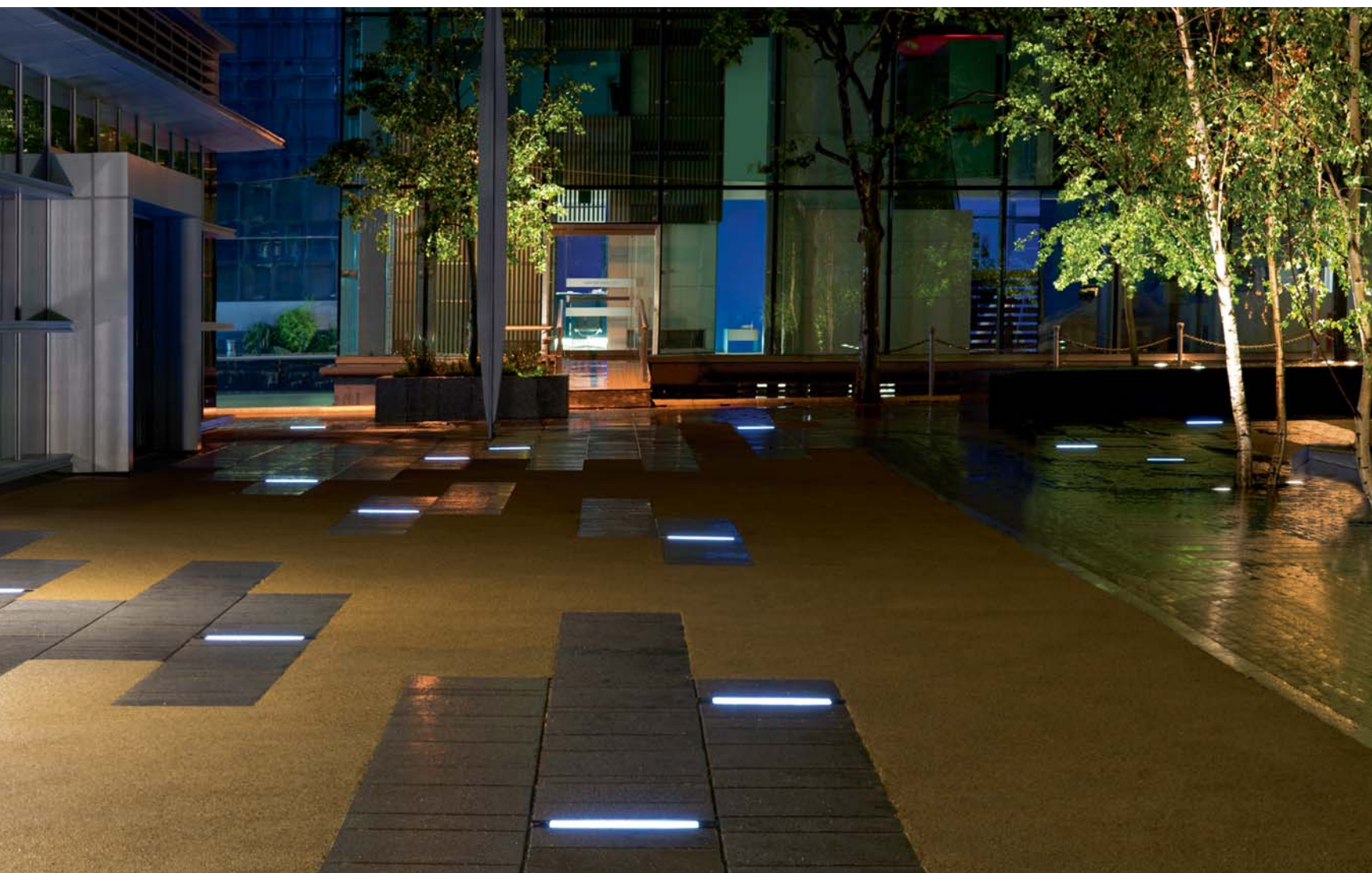

Pan Peninsula Canary Wharf, London (UK). Architect: SOM. Landscape architect: Urban Land Studios. Lighting design: MBLD.

	Part ID	Light source	lm	cd/klm	C ₀ C ₁₈₀	C ₉₀ C ₂₇₀	kg
ETR149	186-0043 [ECG]	T5 21W G5	1900	239	41°/41°	44°/44°	14.0
	186-0044 [ECG]	T5 39W G5	3100	239	41°/41°	44°/44°	14.0

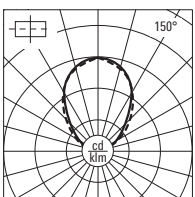
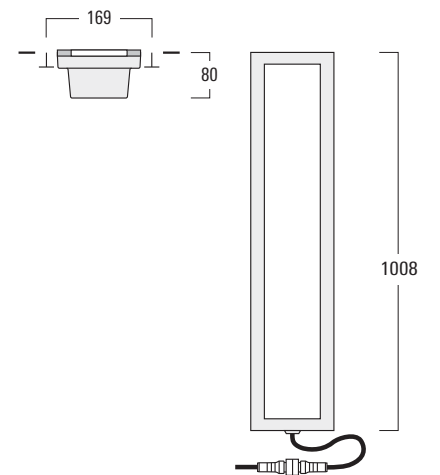

ETR100 SERIES

Inground luminaire, linear, wallwash distribution, asymmetric.

IP67, Class I, IK10+. Die-cast body made from marine-grade aluminium alloy. Stainless steel frame including PCS hardware. Silicone rubber gasket. Factory-sealed termination chamber complete with cable gland and 1.5 m of flexible PVC free cable. IP68 in-line connector. Safety glass; max. load 5 tonnes. Luminaire can be driven over at low speed.

Anodised reflector with 6° or 20° tilt. Integral ECG control gear. Optional 1-10V or DALI interface on request.

Luminaire requires installation blackout BER. To be ordered separately. Option with Anti-Slip ceramic Coating ASC to DIN 51130 (Trip Classification 10) available on request.

Light source

T5 21-39 W

Light distributions

[LA6] [LA20]

Accessories

■ Mounting, page 48

■ Electrical, page 50





[LA6] Linear, wallwash distribution, asymmetric

[LA20] Linear, wallwash distribution, asymmetric



[LA6]	Part ID	Light source	lm	Factor*	kg
ETR140	186-0099 [ECG]	T5 21W G5	1900	1.00	14.0
	186-0100 [ECG]	T5 39W G5	3100	1.63	14.0

[LA20]	Part ID	Light source	lm	Factor*	kg
ETR140	186-0097 [ECG]	T5 21W G5	1900	1.00	14.0
	186-0098 [ECG]	T5 39W G5	3100	1.63	14.0

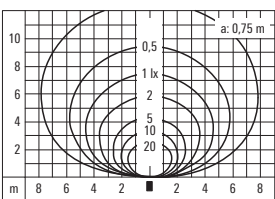
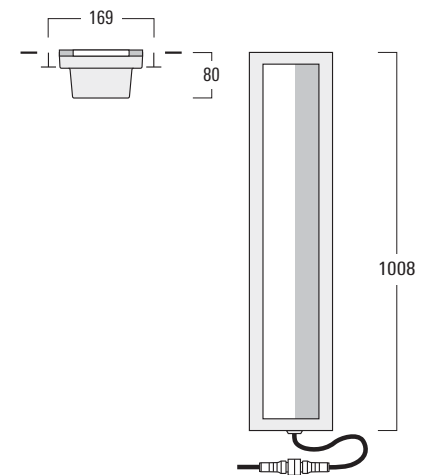

[LA6]

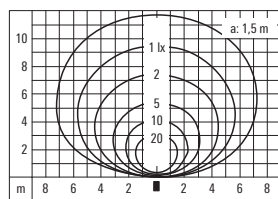

[LA20]

* Multiplier for Isolux value

MOUNTING ACCESSORIES

Installation Cover				kg
for ETC109	185-1850	BE		0.04
for ETC110 / 119	185-0414	BE		0.06
for ETC120 / 129	185-0796	BE		0.17
for ETC329	185-0796	BE		0.17
for ETC130 / 139	185-0325	BE		0.45
for ETC330 / 339	185-0325	BE		0.45
for ETC140	185-0326	BE		0.66
for ETC150	185-1623	BE		1.00

Installation blockouts				D1 / D2	H	Material	kg
for ETC109	185-1855	BET		65/95	120	PA	0.3
for ETC110 / 119	185-0797	BET		95/170	220	PA	0.5
for ETC110 / 119	185-0412	BET		95/240	110	PA	0.5
for ETC120	185-0923	BET		160/225	300	MDPE	1.0
for ETC329	185-9546	BET		160/350	180	PA	1.0
for ETC330 / 339	185-0924	BET		250/305	230	MDPE	1.5
for ETC130 / 139	185-0322	BET		250/270	375	MDPE	1.5
for ESC130	185-0322	BET		250/270	375	MDPE	1.5
for ETC140 ≤ 70 W	185-0323	BET		300/325	420	MDPE	2.5
for ESC140 ≤ 70 W	185-0323	BET		300/325	420	MDPE	2.5
for ETC140 ≥ 100 W	185-1036	BET		300/325	420	AlSi	6.5
for ETC150	185-1622	BET		369/380	435	AlSi	8.0

Installation blockouts made from anodised aluminium

	Type I		Type II		D1	D2	A	kg
	C=160 mm	C=130 mm						
for ETV120	186-0306	186-0281	BEV (for 1 luminaire)		54	120	675	3.4 / 2.5
	186-0307	186-0282	BEV (for 2 luminaires)		54	120	1304	6.3 / 4.6
	186-0308	186-0283	BEV (for 3 luminaires)		54	120	1933	9.1 / 6.7
	186-0309	186-0284	BEV (for 4 luminaires)		54	120	2562	12.0 / 8.9
for ETV130	186-0310	186-0285	BEV (for 1 luminaire)		54	120	975	4.7 / 3.6
	186-0311	186-0286	BEV (for 2 luminaires)		54	120	1904	9.0 / 6.7
	186-0312	186-0287	BEV (for 3 luminaires)		54	120	2833	13.2 / 9.8
	186-0313	186-0288	BEV (for 4 luminaires)		54	120	3762	17.5 / 12.9
for ETV140	186-0314	186-0289	BEV (for 1 luminaire)		54	120	1275	6.1 / 4.5
	186-0315	186-0290	BEV (for 2 luminaires)		54	120	2504	11.7 / 8.7
	186-0316	186-0291	BEV (for 3 luminaires)		54	120	3733	17.4 / 12.8
	186-0317	186-0292	BEV (for 4 luminaires)		54	120	4962	23.0 / 16.9

Installation blockouts

made from anodised aluminium and stainless steel				D1	D2	C	A	kg
for ETR139	186-0101	BER (for 1 luminaire)		169	251	150	570	7.6
for ETR140 / 149	186-0102	BER (for 1 luminaire)		169	251	150	1020	12.7
for ETR159	186-0103	BER (for 1 luminaire)		169	251	150	1470	17.9

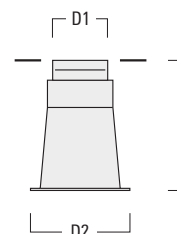

Installation Blockout for
ETC109
ETC110
ETC119

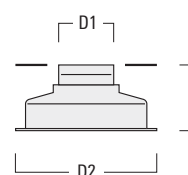

Installation Blockout for
ETC110
ETC119
ETC329
ETC330 / ETC339

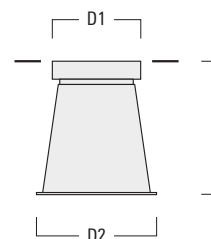

Installation Blockout for
ETC120 / ETC129
ETC130 / ETC139
ETC140 ≤ 70 W
ETC140 ≥ 100 W
ETC150
ESC130 / ESC140



Installation Blockout for
ETV120
ETV130
ETV140

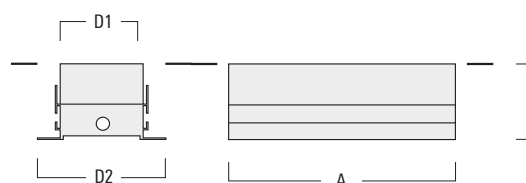

Installation Blockout for
ETR139
ETR140 / ETR149
ETR159

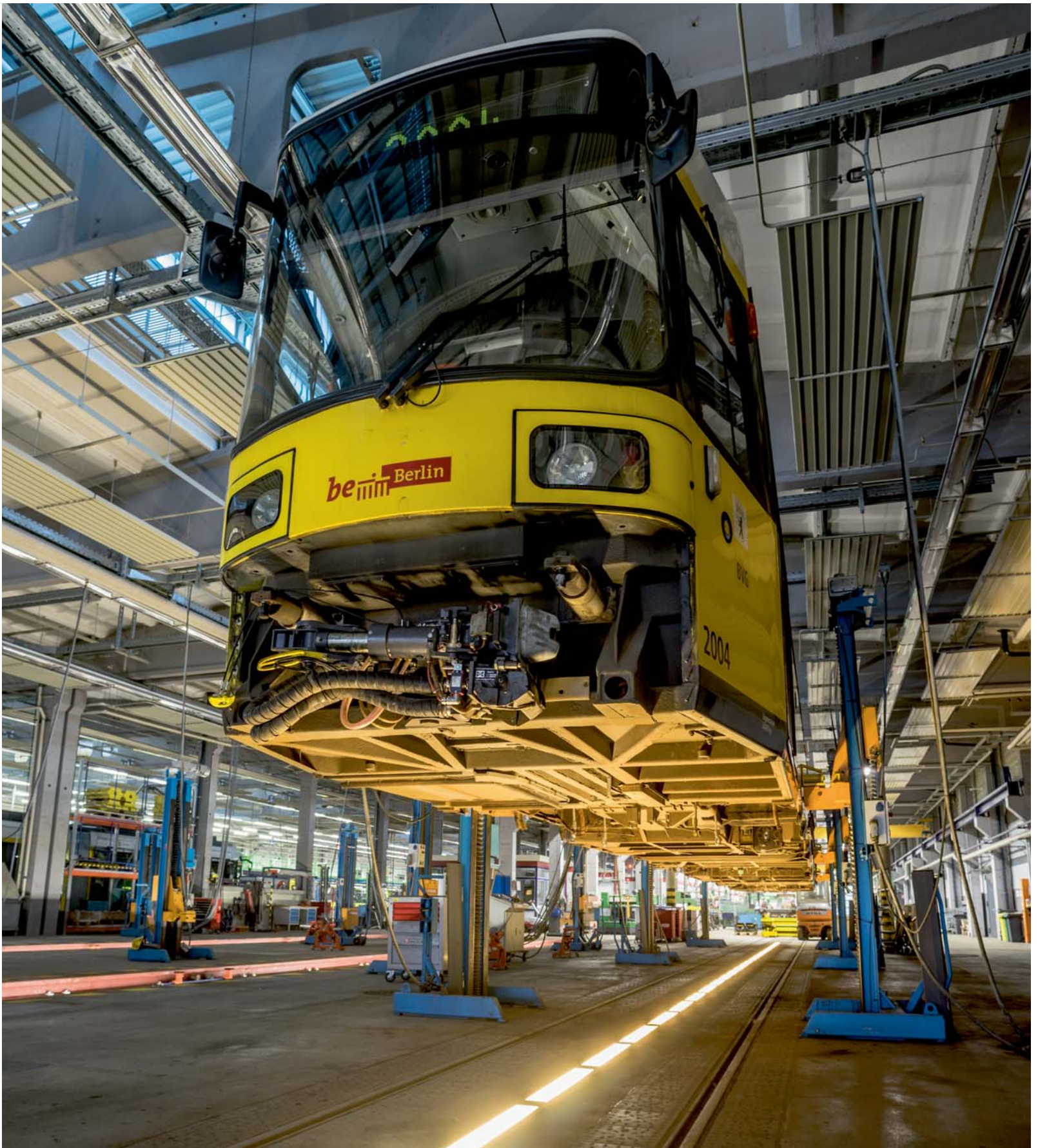

Tram maintenance workshop Marzahn, Berlin (D)

ELECTRICAL ACCESSORIES

Mains converter (230V / 12V)

IP20, Class I. Mounting to 35 mm rail.

			A	B	C
for ETC109	400-0302	TVE-DC 12 V/12 W	89	59	54
	400-0309	TVE-DC 12 V/48 W	89	59	72

Mains converter (230V / 24V)

IP20, Class I. Mounting to 35 mm rail.

			A	B	C
for ETC110 / 119	400-0310	TVE-DC 24 V/12 W	90	61	18
	400-0311	TVE-DC 24 V/60 W	89	59	72

Magnetic transformer (230V / 24V)

IP65, Class II.

			A	B	C
for ETC110 / 119	185-2884	TVM-AC 24 V/20 W	40	65	90
	185-2885	TVM-AC 24 V/50 W	140	65	90

Sealable Junction Box

for EFC/ESC/ETC/ETV/ETR 185-1624 SJB

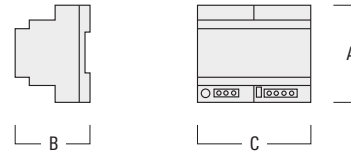

Mains converter

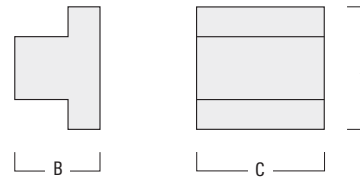

Magnetic transformer

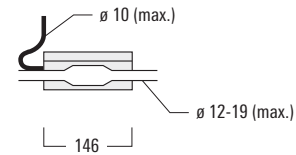

Sealable Junction Box



Sculpture installation "Im Aufbruch". Parliament NRW Duesseldorf (D). Architect: Peter Andres, Hamburg. Artists: Stefanie Schenk-Busse & Björn Busse, Visbeck-Meschede. Planning: Heuel-Schauerte, Meschede.

OPTICAL ACCESSORIES



Gimbal

A maximum of one internal optical accessory.

Flood lens IO-360*

for ETC120-GB	185-2865
for ETC130-GB / ETC330-GB	185-2866
for ETC140-GB	185-2867

Linear spread lens IO-180*

for ETC120-GB	185-9612
for ETC130-GB / ETC330-GB	185-2632
for ETC140-GB	185-2719

Honeycomb louvre IW*

for ETC120-GB	185-2869
for ETC130-GB / ETC330-GB	185-2870
for ETC140-GB	185-2871

* does not fit in combination with [B] lens

Fixed

A maximum of one internal optical accessory.

Flood lens IO-360

for ETC110 – 1 LED / 3 LED	185-0899
----------------------------	----------

Linear spread lens IO-180

for ETC110 – 1 LED / 3 LED	185-0895
----------------------------	----------

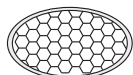

IW



IO-360



IO-180

medium beam

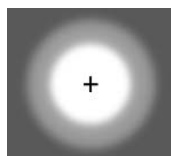

medium beam

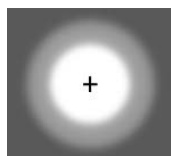

with IO-360



with IO-180

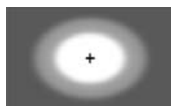

OPTICAL ACCESSORIES

Gimbal

A maximum of two internal optical accessories.

Flood lens IO-360

for ETC130-GB	185-2465
for ETC140-GB	185-2467

Linear spread lens IO-180

for ETC130-GB	185-2466
for ETC140-GB	185-2468

Colour filter IF

	red	green	blue	yellow
for ETC130-GB	185-2457	185-2458	185-2459	185-2460
for ETC140-GB	185-2461	185-2462	185-2463	185-2464

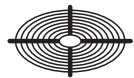

IR



IL



IQ



IF



IO-360



IO-180



IO-6



IO-20

very narrow beam

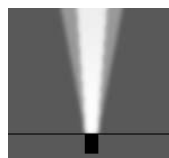

medium beam

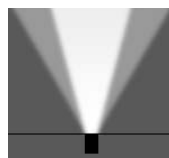

with IO-6



with IO-20



CTA®



slip resistant ASC coating optional

Fixed

ETC330: A maximum of one internal optical accessory.

ESC130 / ESC140 / ETC120 / ETC130 / ETC140 / ETC150:

A maximum of three internal optical accessories.

Flood lens IO-360

for ETC120	185-0900
for ETC130 / ETC330	185-0901
for ETC140	185-0902
for ETC150	185-1640

Linear spread lens IO-180

for ETC120	185-0896
for ETC130 / ETC330	185-0897
for ETC140	185-0898
for ETC150	185-1639

Directional lens IO-6

for ETC120	185-1634
for ETC130 / ETC330	185-0891
for ETC140	185-0893
for ETC150	185-1635

Directional lens IO-20

for ETC120	185-1637
for ETC130 / ETC330	185-0892
for ETC140	185-0894
for ETC150	185-1638

Colour filter IF

	red	green	blue	yellow
for ETC120	185-0904	185-0912	185-0908	185-0884
for ETC130 / ETC330	185-0905	185-0415	185-0909	185-0885
for ETC140	185-0906	185-0419	185-0910	185-0886
for ETC150	185-1641	185-1642	185-1643	185-1644

Linear louvre IL

for ETC120 [M]	185-0793
for ETC130 [B] [M]	185-0794
for ETC140 [B] [M]	185-0795
for ETC150 [M]	185-1626

Concentric louvre IR

for ETC120 [EE]	185-0789
for ETC130 [EE]	185-0790
for ETC140 [EE]	185-0791
for ETC150 [EE]	185-1625

Source Shield IQ

for ETC130 [EE]	185-0876
for ETC140 [EE]	185-0877
for ETC150 [EE]	185-1632

Cool Touch Adaptor CTA®

for ETC130	185-0728
for ESC130	185-0728
for ETC140	185-0727
for ESC140	185-0727
for ETC150	185-1645

IOS® Beam distributions for wall luminaires recessed

[A75] forward throw, asymmetric

[] diffused

Wall luminaires recessed

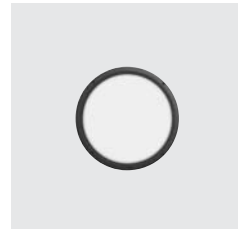

TRO200 LED 56

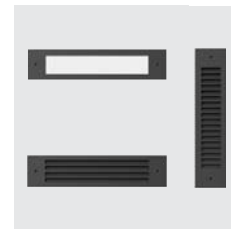

STO / STL / SVL100 LED 58



STI / STF100 LED 60

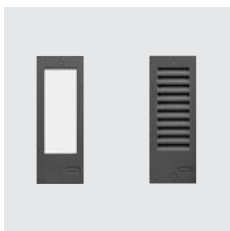

SVO / SVL200 LED 62



STO / STL200 LED 64



STI200 LED 66

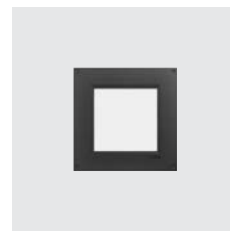

QRO300 LED 68



QRI300 LED 70



QRI300 72

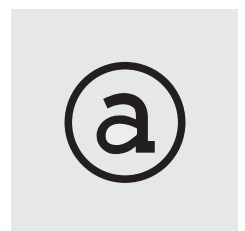

ACCESSORIES
■ Mounting 74

TRO200 SERIES

Recessed luminaire, diffused distribution.

IP55, Class I, IK10. Marine-grade die-cast aluminium alloy. 5CE superior corrosion protection including PCS hardware. Powdercoat finish in RAL 9004, RAL 9006, RAL 9007 or RAL 9016. Silicone rubber gasket. Polycarbonate lens. Two cable entries.

Integral EC electronic converter. Factory installed LED circuit board. LED boards can be easily removed for upgrading.

A pre-installation blackout is available and recommended for mounting in concrete walls. To be ordered separately.

Light source

LED 12 W, 3000 K,
for 4000 K refer to www.we-ef.com

Accessories

■ Mounting, page 74

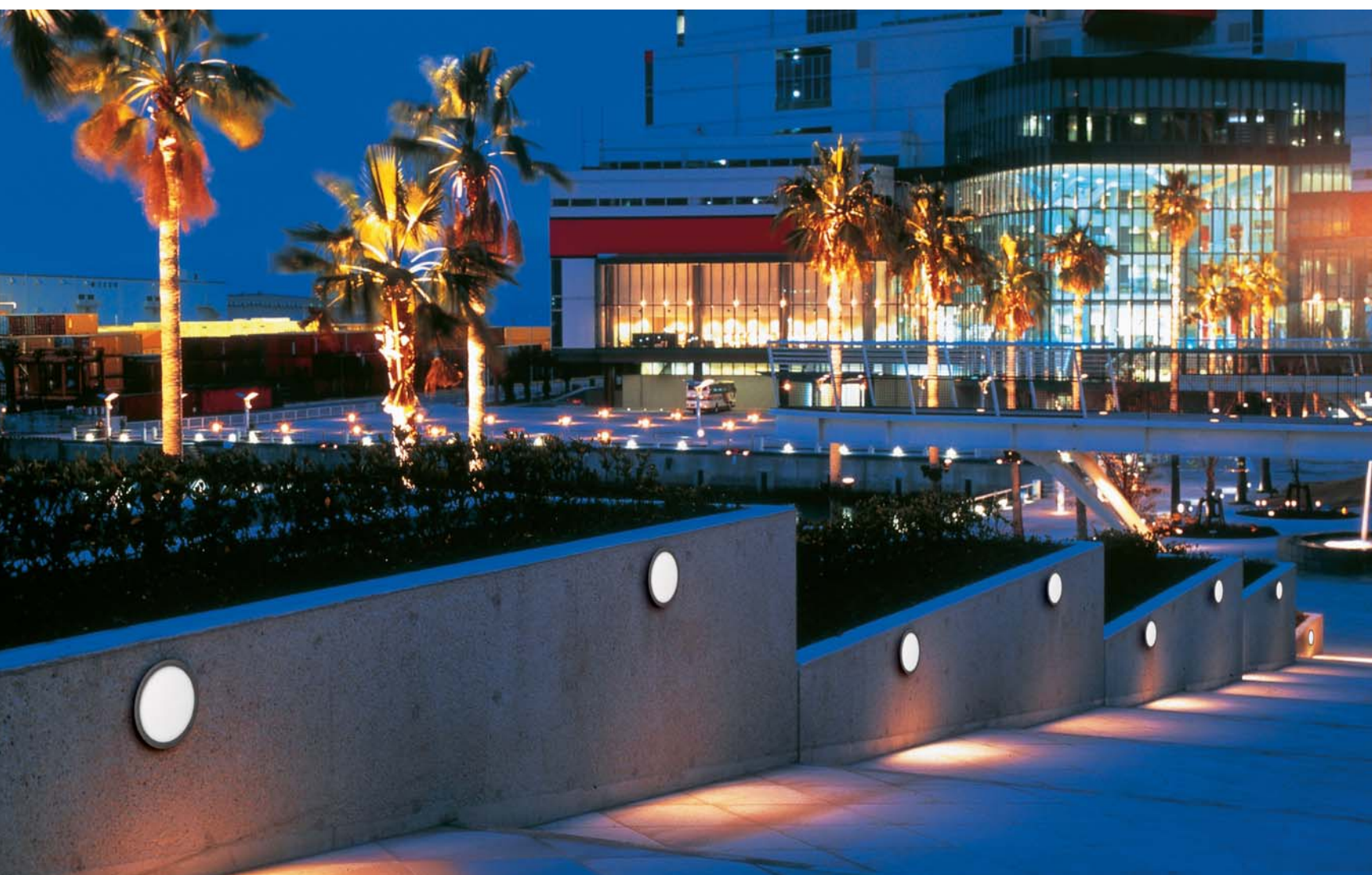



	Part ID	Light source	K	lm*	Factor**	kg
TRO259	195-9146	LED-FT 12W	3000	1860	1.00	2.1

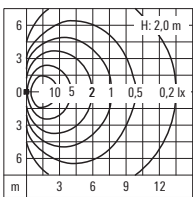
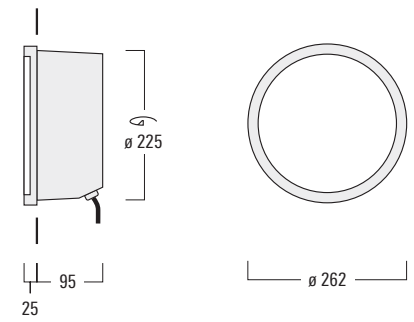

* Nominal lumen output based on LED manufacturers data at 25°C T_c. For rated lumens at 25°C T_q and latest data refer to www.we-ef.com.
 ** Multiplier for Isolux value

ST0100 / STL100 / SVL100 SERIES

Steplights, diffused distribution.

IP66, Class I, IK10. Marine-grade die-cast aluminium alloy. 5CE superior corrosion protection including PCS hardware. Powdercoat finish in RAL 9004, RAL 9006, RAL 9007 or RAL 9016. Silicone rubber gasket. Polycarbonate lens. Two cable entries.

Integral EC electronic converter. Factory installed LED circuit board. LED boards can be easily removed for upgrading.

ST0134: Optional version with stainless steel frame VA available.

A pre-installation blockout is available and recommended for mounting in concrete walls. To be ordered separately.

Light source

LED 6 W, 3000 K,
for 4000 K refer to www.we-ef.com

Accessories

■ Mounting, page 74





STO134



STL134



SVL134

	Part ID	Light source	K	lm*	Factor**	kg
STO134	190-9002	LED 6W / 500 mA	3000	710	1.00	0.9
STO134-VA	190-9014	LED 6W / 500 mA	3000	710	1.00	0.9

	Part ID	Light source	K	lm*	Factor**	kg
STL134	190-9005	LED 6W / 500 mA	3000	710	1.00	0.9

	Part ID	Light source	K	lm*	Factor**	kg
SVL134	190-9017	LED 6W / 500 mA	3000	710	1.00	0.9

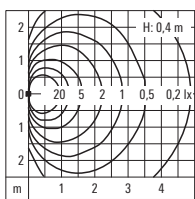
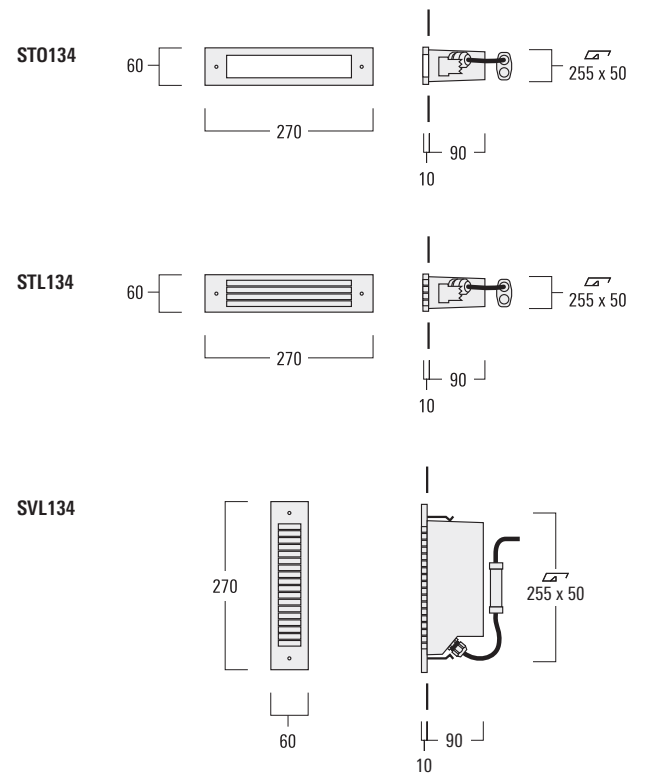

STO

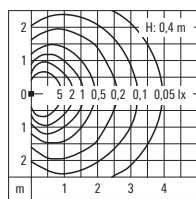

STL / SVL

* Nominal lumen output based on LED manufacturers data at 85°C T_c. For rated lumens at 25°C T_q and latest data refer to www.we-ef.com.
 ** Multiplier for Isolux value

STI100 / STF100 SERIES

Steplights, forward throw distribution, asymmetric.

IP66, Class I, IK10. Marine-grade die-cast aluminium alloy. 5CE superior corrosion protection including PCS hardware. Powdercoat finish in RAL 9004, RAL 9006, RAL 9007 or RAL 9016. Silicone rubber gasket. Polycarbonate lens. Two cable entries.

Integral EC electronic converter. Factory installed LED circuit board. LED boards can be easily removed for upgrading.

A pre-installation blackout is available and recommended for mounting in concrete walls. To be ordered separately.

Light source

LED 6 W, 3000 K,
for 4000 K refer to www.we-ef.com

Light distribution

[A75]

Accessories

■ Mounting, page 74



Castle square. Lenzen (D)



[A75] Asymmetric forward throw distribution



STI134



STF134

	Part ID	Light source	K	lm*	Factor**	kg
STI134	190-9008	LED 6W / 500 mA	3000	710	1.00	0.9

[A75]	Part ID	Light source	K	lm*	Factor**	kg
STF134	190-9011	LED 6W / 500 mA	3000	710	1.00	0.9

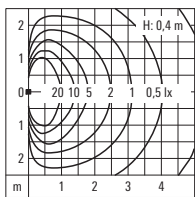
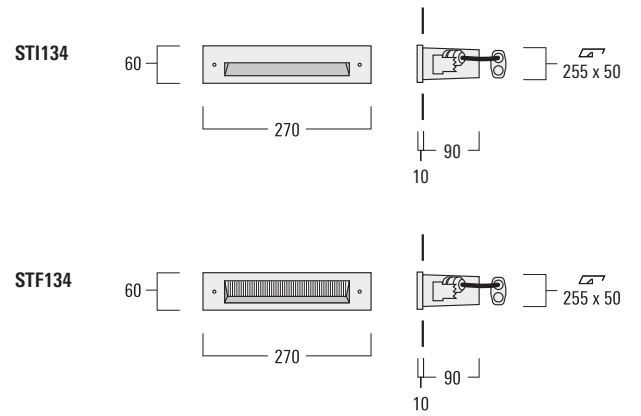

STI

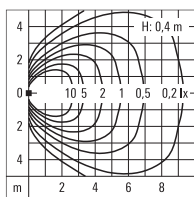

STF

* Nominal lumen output based on LED manufacturers data at 85°C T_c. For rated lumens at 25°C T_q and latest data refer to www.we-ef.com.
 ** Multiplier for Isolux value

SVO200 / SVL200 SERIES

Steplights, diffused distribution.

IP55, Class I, IK10. Marine-grade die-cast aluminium alloy. 5CE superior corrosion protection including PCS hardware. Powdercoat finish in RAL 9004, RAL 9006, RAL 9007 or RAL 9016. Silicone rubber gasket. Polycarbonate lens. Two cable entries.

Integral EC electronic converter. Factory installed LED circuit board. LED boards can be easily removed for upgrading.

SV0259: Optional version with stainless steel frame VA available.

A pre-installation blockout is available and recommended for mounting in concrete walls. To be ordered separately.

Light source

LED 6 W, 3000 K,
for 4000 K refer to www.we-ef.com

Accessories

■ Mounting, page 74



Harbour promenade, Eckernförde (D). Landscape architect: Seebauer Wefers und Partner, Berlin.



SV0259 VA



SV0259



SVL259

	Part ID	Light source	K	lm*	Factor**	kg	
	SV0259	133-0323	6 LED 6W / 350 mA	3000	807	1.00	1.1
	SV0259 VA	133-0358	6 LED 6W / 350 mA	3000	807	1.00	1.1
	SVL259	133-0360	6 LED 6W / 350 mA	3000	807	1.00	1.2

SV0259

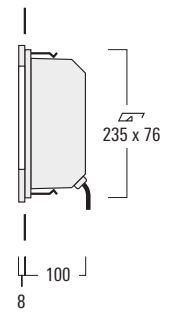
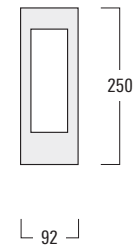

SVL259

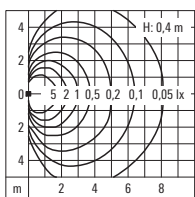
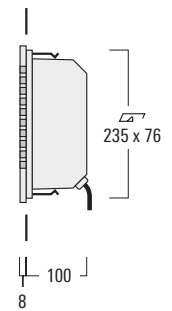
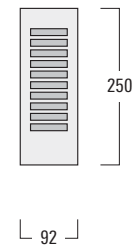

SVO

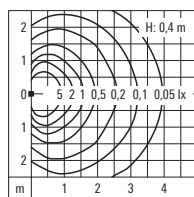

SVL

* Nominal lumen output based on LED manufacturers data at 85°C T_J. For rated lumens at 25°C T_q and latest data refer to www.we-ef.com.
 ** Multiplier for Isolux value

STO200 / STL200 SERIES

Steplights, diffused distribution.

STO209 / STL209 / STO259 / STL259: IP55, Class I. IK10. STO279: IP66, Class I. IK10.

Marine-grade die-cast aluminium alloy. 5CE superior corrosion protection including PCS hardware. Powdercoat finish in RAL 9004, RAL 9006, RAL 9007 or RAL 9016.

Silicone rubber gasket. Polycarbonate lens. Two cable entries.

Integral EC electronic converter. Factory installed LED circuit board. LED boards can be easily removed for upgrading.

STO209 / STO259 / STO279: Optional version with stainless steel frame VA available.

A pre-installation blockout is available and recommended for mounting in concrete walls. To be ordered separately.

Version with emergency light for AC / DC operation, with or without switching gate or monitoring module available on request.

Light source

LED 4-9 W, 3000 K,

for 4000 K refer to www.we-ef.com



Accessories

■ Mounting, page 74

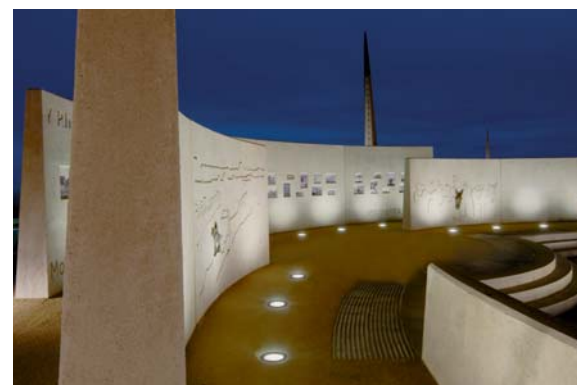

Drift Park. Rhyl, North Wales (UK). Landscape architect: Brock Carmichael Landscape Architects, Liverpool.



ST0259 VA



ST0259

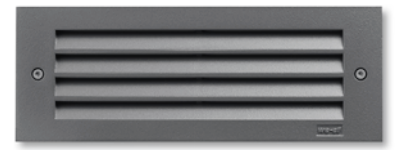

STL259

	Part ID	Light source	K	lm*	Factor**	kg	
	ST0209	133-0328	4 LED 4W / 350 mA	3000	538	0.67	0.9
	ST0209 VA	133-0329	4 LED 4W / 350 mA	3000	538	0.67	0.9
	ST0259	133-0340	6 LED 6W / 350 mA	3000	807	1.00	1.2
	ST0259 VA	133-0319	6 LED 6W / 350 mA	3000	807	1.00	1.2
	ST0279	133-0352	9 LED 9W / 350 mA	3000	1211	1.50	2.3
	ST0279 VA	133-0354	9 LED 9W / 350 mA	3000	1211	1.50	2.3

	Part ID	Light source	K	lm*	Factor**	kg	
	STL209	133-0324	4 LED 4W / 350 mA	3000	538	0.67	1.0
	STL259	133-0308	6 LED 6W / 350 mA	3000	807	1.00	1.3

ST0209

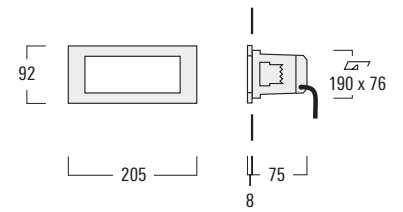

ST0259

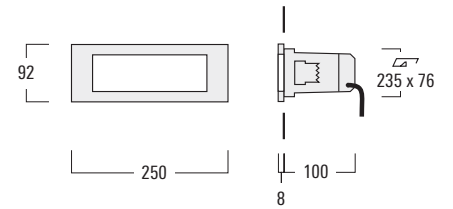

ST0279

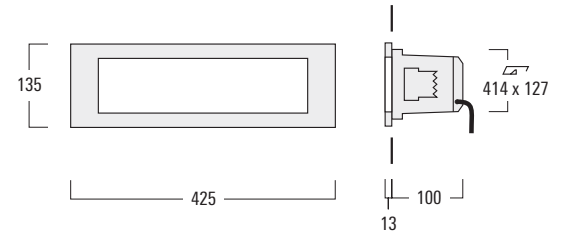

STL209

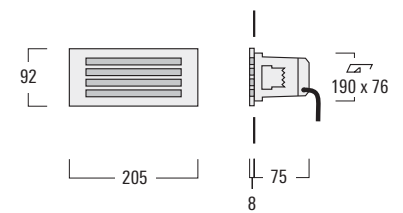

STL259

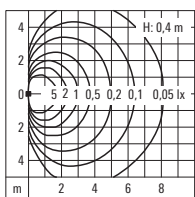
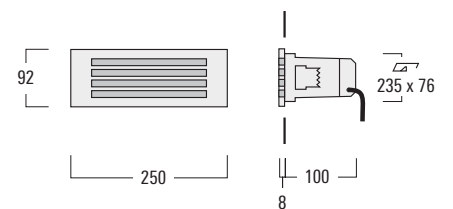

STO

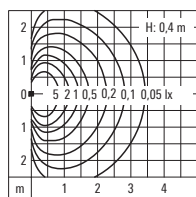

STL

* Nominal lumen output based on LED manufacturers data at 85°C T_J. For rated lumens at 25°C T_q and latest data refer to www.we-ef.com.
 ** Multiplier for Isolux value

STI200 SERIES

Steplight, forward throw distribution, asymmetric.

STI259: IP55, Class I. IK10. STI279: IP66, Class I. IK10. Marine-grade die-cast aluminium alloy. 5CE superior corrosion protection including PCS hardware. Powdercoat finish in RAL 9004, RAL 9006, RAL 9007 or RAL 9016. Silicone rubber gasket. Safety glass lens.

Two cable entries.

Integral EC electronic converter. Factory installed LED circuit board. LED boards can be easily removed for upgrading.

A pre-installation blockout is available and recommended for mounting in concrete walls. To be ordered separately.

Version with emergency light for AC / DC operation, with or without switching gate or monitoring module available on request.

Light source

LED 6-9 W, 3000 K,

for 4000 K refer to www.we-ef.com

Accessories

■ Mounting, page 74

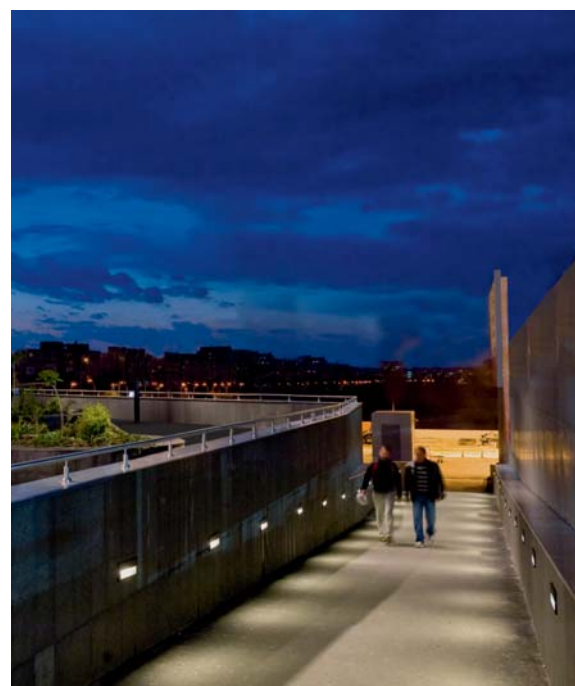
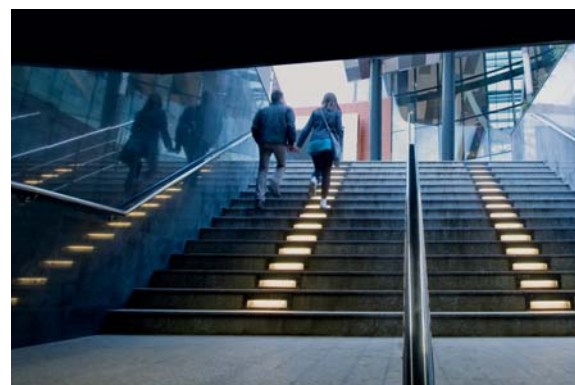

Sun Plaza Shopping Mall. Bucarest (RO). Architects: Chapman Taylor. Lighting design: Scott Beleuchtung.

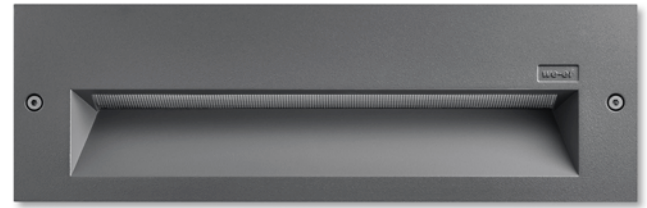

	Part ID	Light source	K	lm*	Factor**	kg
STI259	133-0405	40 LED 6W / 250 mA	3000	840	1.00	1.2
STI279	133-0402	60 LED 9W / 250 mA	3000	1260	1.50	3.0

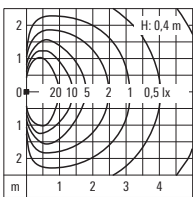
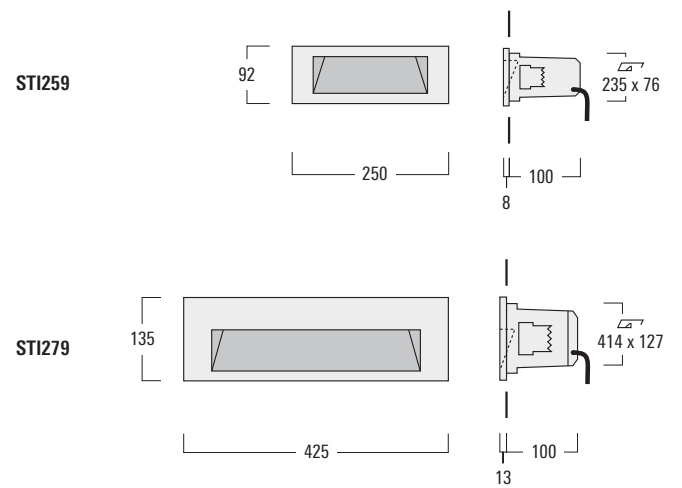

* Nominal lumen output based on LED manufacturers data at 85°C T_J. For rated lumens at 25°C T_q and latest data refer to www.we-ef.com.
 ** Multiplier for Isolux value

QR0300 SERIES

Recessed luminaire, diffused distribution.

IP55, Class I, IK10. Marine-grade die-cast aluminium alloy. 5CE superior corrosion protection including PCS hardware. Powdercoat finish in RAL 9004, RAL 9006, RAL 9007 or RAL 9016. Silicone rubber gasket. Polycarbonate lens. Two cable entries.

Integral EC electronic converter. Factory installed LED circuit board. LED boards can be easily removed for upgrading.

A pre-installation blackout is available and recommended for mounting in concrete walls. To be ordered separately.

Light source

LED 12-24 W, 3000 K,
for 4000 K refer to www.we-ef.com

Accessories

■ Mounting, page 74



Train station Berlin Südkreuz. Berlin (D). Architect: J.S.K. GmbH, Berlin. Lighting design: DE Consult, Berlin.



	Part ID	Light source	K	lm*	Factor**	kg
QR0359	197-0041	LED-FT 12W	3000	1860	1.00	3.2
QR0379	197-9081	LED-FT 24W	3000	3795	2.04	4.3

QR0359

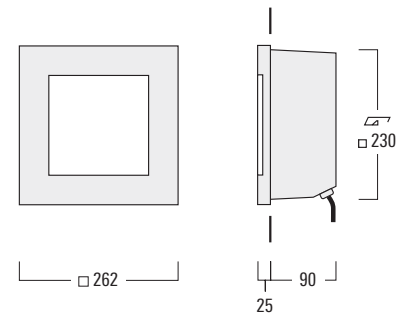

QR0379

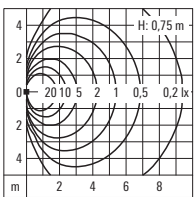
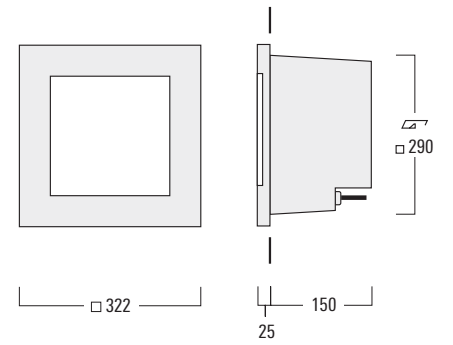

* Nominal lumen output based on LED manufacturers data at 25°C T_c. For rated lumens at 25°C T_q and latest data refer to www.we-ef.com.
 ** Multiplier for Isolux value

ORI300 SERIES

Recessed luminaire, forward throw distribution, asymmetric.

IP55, Class I. IK08. Marine-grade die-cast aluminium alloy. 5CE superior corrosion protection including PCS hardware. Powdercoat finish in RAL 9004, RAL 9006, RAL 9007 or RAL 9016. Silicone rubber gasket. Safety glass lens. Two cable entries.

Integral EC electronic converter. Factory installed LED circuit board. LED boards can be easily removed for upgrading.

A pre-installation blackout is available and recommended for mounting in concrete walls. To be ordered separately.

Light source

LED 6 W, 3000 K,
for 4000 K refer to www.we-ef.com

Accessories

■ Mounting, page 74



John Curtin School of Medical Research. Canberra (AUS). Architect: Lyons. Lighting design: Umow Lai & Associates.



	Part ID	Light source	K	lm*	Factor**	kg
QRI359	197-0367	40 LED 6W / 250 mA	3000	840	1.00	3.4

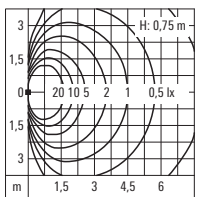
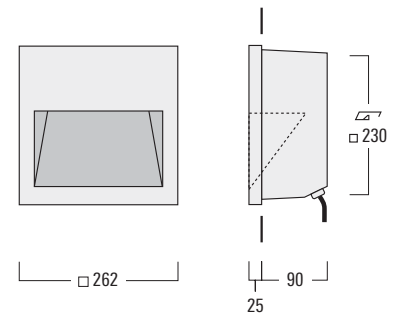

* Nominal lumen output based on LED manufacturers data at 85°C T_J. For rated lumens at 25°C T_q and latest data refer to www.we-ef.com.
 ** Multiplier for Isolux value

ORI300 SERIES

Recessed luminaire, forward throw distribution, asymmetric.

IP55, Class I. IK08. Marine-grade die-cast aluminium alloy. 5CE superior corrosion protection including PCS hardware. Powdercoat finish in RAL 9004, RAL 9006, RAL 9007 or RAL 9016. Silicone rubber gasket. Textured safety glass lens. Two cable entries.

Integral HPF or ECG control gear.

A pre-installation blockout is available and recommended for mounting in concrete walls. To be ordered separately.

Light source
HIT 20-70 W

Accessories
■ Mounting, page 74

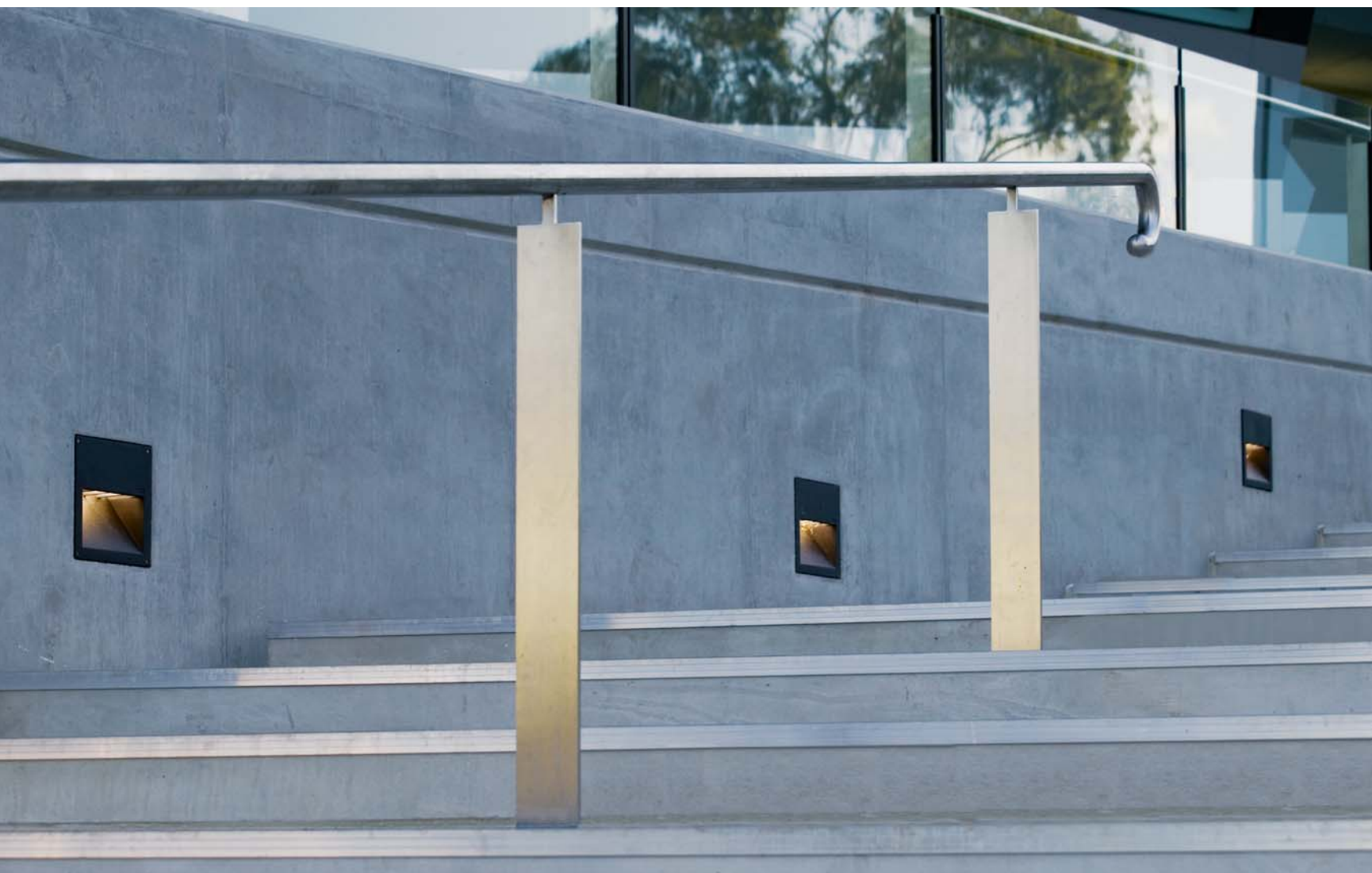

John Curtin School of Medical Research. Canberra (AUS). Architect: Lyons. Lighting design: Umow Lai & Associates.



	Part ID	Light source	lm	Factor*	kg
QRI354	197-0324 [ECG]	HIT-CE 20W G12	1650	0.46	4.2
	197-0326 [ECG]	HIT-CE 35W G12	3600	1.00	4.2
	197-0327 [HPF]	HIT-CE 70W G12	7300	2.03	5.4
QRI374	197-0329 [ECG]	HIT-CE 70W G12	7300	2.03	5.8

QRI354

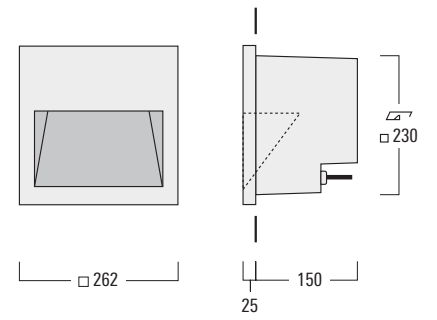

QRI374

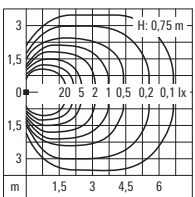
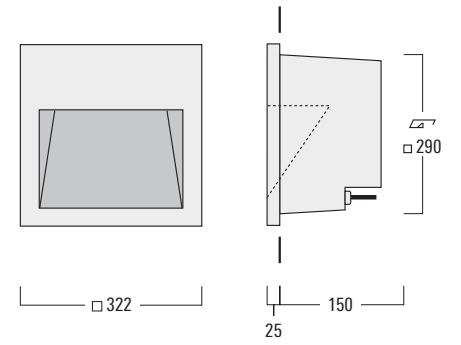

* Multiplier for Isolux value

MOUNTING ACCESSORIES

Installation blockouts — Luminaire frame proud of surface

for round luminaires			C
for TR0259	195-0191	BTR25-I	125
for rectangular steplights – vertical orientation			C
for SVL134	190-9030	BST13-I	125
for SVO259 / SVL259	133-0076	BST25-I	130
for rectangular steplights – horizontal orientation			C
for STO134 / STL134 / STI134 / STF134	190-9030	BST13-I	125
for STO209 / STL209	133-0075	BST20-I	105
for STO259 / STL259 / STI259	133-0076	BST25-I	130
for STO279 / STI279	133-0217	BST27-I	125
for square luminaires (installation depth 90 mm)			C
for QRO359 / QRI354	197-0129	BQR25-I	125
for square luminaires (installation depth 150 mm)			C
for QRI354	197-0130	BQR25-I	180
for QRI374	197-0131	BQR30-I	180

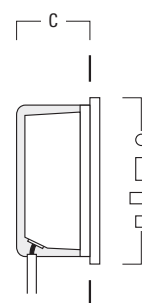

Type I
Luminaire frame proud of surface

Installation blockouts — Luminaire frame flush with surface

for round luminaires			C
for TR0259	195-0193	BTR25-II	150
for rectangular luminaires – vertical orientation			C
for SVL134	190-9031	BST13-II	135
for SVO259 / SVL259	133-0078	BST25-II	140
for rectangular steplights – horizontal orientation			C
for STO134 / STL134 / STI134 / STF134	190-9031	BST13-II	135
for STO209 / STL209	133-0077	BST20-II	115
for STO259 / STL259 / STI259	133-0078	BST25-II	140
for STO279 / STI279	133-0219	BST27-II	135
for square luminaires (installation depth 90 mm)			C
for QRO359 / QRI359	197-0132	BQR25-II	150
for square luminaires (installation depth 150 mm)			C
for QRI354	197-0133	BQR25-II	205
for QRI374	197-0134	BQR30-II	205

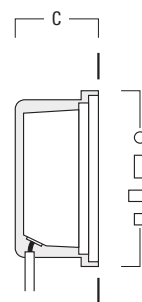

Type II
Luminaire frame flush with surface



Marine Hall Gardens. Fleetwood (UK). Landscape architect & Lighting designer: BCA Landscape.

IOS® Beam distributions for wall luminaires surface mounted

- [LB] linear, wide beam, symmetric
- [LM] linear, medium beam, symmetric
- [LE] linear, narrow beam, symmetric
- [LEE] linear, very narrow beam, symmetric
- [LA10] linear, wallwash, asymmetric

- [P/O] precision beam up, wide beam down
- [P/M] precision beam up, medium beam down
- [P/P] precision beam up and down
- [M/M] medium beam up and down

- [M] medium beam, symmetric
- [E] narrow beam, symmetric
- [EE] very narrow beam, symmetric
- [EES] very narrow beam, symmetric, 'sharp cut-off'

- [M/M] medium beam up and down
- [E/E] narrow beam up and down
- [E/M] narrow beam up and medium beam down
- [E/S] narrow beam up and side throw down

- [S70] streetlighting
- [R65] rectangular forward throw
- [A60] forward throw, asymmetric
- [S] side throw, asymmetric
- [A] forward throw, asymmetric

- [] diffused

Wall luminaires surface mounted



VLR100 LED 78



UDN300 82



QLS400 LED 86



VLS400 LED 90



SLS400 LED 94



OLV300 LED 98



OLV300 102



PIA200 LED 106



PIA200 108



DLO / DLG200 LED 110

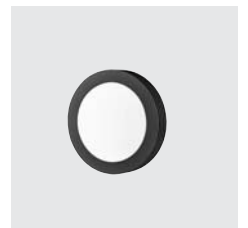

XLO200 LED 112

VLR100 SERIES

Wall luminaire, linear, wide, medium, narrow or very narrow beam distribution, symmetric or wallwash distribution, asymmetric.

IP68 (up to 1 m), Class I. Marine-grade all aluminium construction. Anodized aluminium extrusion. PCS hardware. Powdercoat finish in RAL 9004, RAL 9006, RAL 9007 or RAL 9016. PMMA cover. Silicone rubber gasket.

Linear PMMA LED lens. Factory installed LED circuit board. LED boards can be easily removed for upgrading.

1.2 m connecting cable, UV stabilized, PVC free. Luminaire is factory sealed and does not need to be opened during installation and can be tilted up to 180°.

VLR110: Separate LED driver with DALI interface.

VLR120 / VLR130 / VLR140 / VLR150: Integral LED driver with DALI interface.

Separate LED driver on request.

Light source

LED 7.5-37.5 W, 3000 K,
for 4000 K refer to www.we-ef.com

Light distributions

[LB] [LM] [LE] [LEE] [LA10]

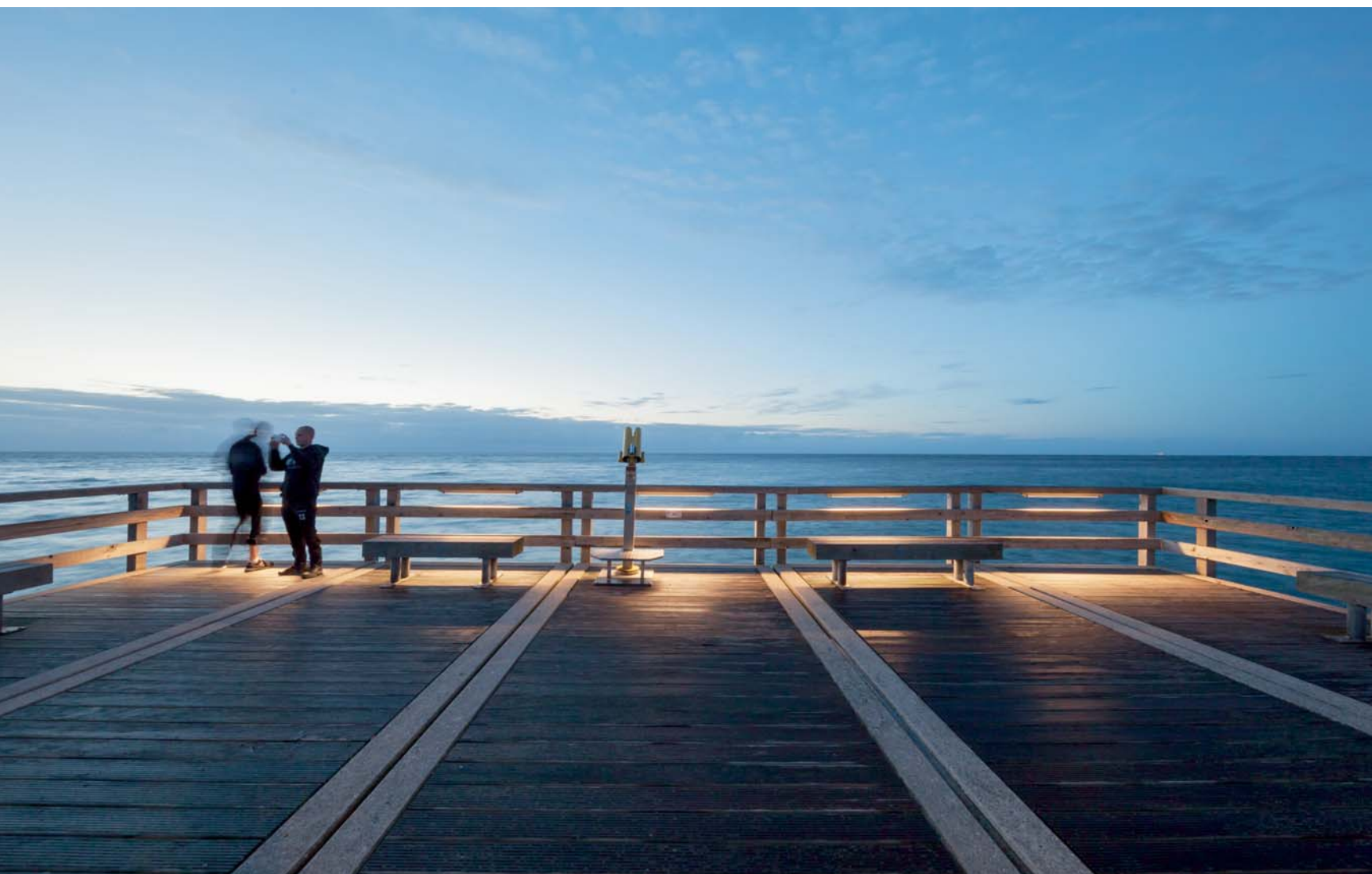

Pier seaside Heiligendamm (D). Lighting design: Institut für Gebäude + Energie + Licht Planung, Prof. Dr.-Ing. Thomas Römhild, Wismar.

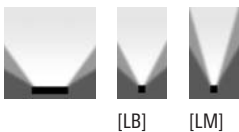

[LB] Linear, wide beam distribution, symmetric
 [LM] Linear, medium beam distribution, symmetric



[LB]	Part ID	Light source	K	lm*	cd/klm	C ₀ C ₁₈₀	C ₉₀ C ₂₇₀	kg
VLR110	187-0023	60 LED 7.5W	3000	1125	430	29°/29°	45°/45°	1.20
VLR120	187-0024	120 LED 15W	3000	2250	430	29°/29°	45°/45°	1.20
VLR130	187-0025	180 LED 22.5W	3000	3375	430	29°/29°	45°/45°	3.25
VLR140	187-0026	240 LED 30W	3000	4500	430	29°/29°	45°/45°	4.00
VLR150	187-0027	300 LED 37.5W	3000	5625	430	29°/29°	45°/45°	4.75

[LM]	Part ID	Light source	K	lm*	cd/klm	C ₀ C ₁₈₀	C ₉₀ C ₂₇₀	kg
VLR110	187-0001	60 LED 7.5W	3000	1125	827	14°/14°	49°/49°	1.20
VLR120	187-0002	120 LED 15W	3000	2250	827	14°/14°	49°/49°	1.20
VLR130	187-0003	180 LED 22.5W	3000	3375	827	14°/14°	49°/49°	3.25
VLR140	187-0004	240 LED 30W	3000	4500	827	14°/14°	49°/49°	4.00
VLR150	187-0028	300 LED 37.5W	3000	5625	827	14°/14°	49°/49°	4.75

Honeycomb louvre IW**

- for VLR110 187-0320
- for VLR120 187-0321
- for VLR130 187-0322
- for VLR140 187-0323
- for VLR150 187-0324

** not suitable for [LB] and [LA10]

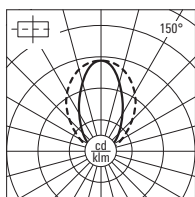

[LB]

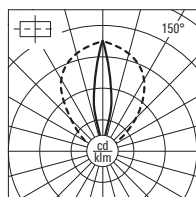

[LM]

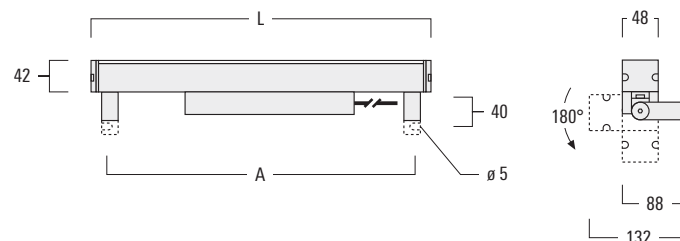

Dimensions	L	A
VLR110	328 mm	287 mm (separate LED driver)
VLR120	628 mm	587 mm
VLR130	928 mm	887 mm
VLR140	1228 mm	1187 mm
VLR150	1528 mm	1487 mm

Other lengths in 100 mm increments available on request
 (228 mm –1528 mm)

* Nominal lumen output based on LED manufacturers data at 25°C T_a. For rated lumens at 25°C T_a and latest data refer to www.we-ef.com.

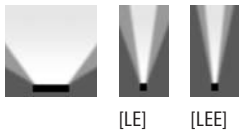

[LE] Linear, narrow beam distribution, symmetric
 [LEE] Linear, very narrow beam distribution, symmetric

[LE]	Part ID	Light source	K	lm*	cd/klm	C ₀ C ₁₈₀	C ₉₀ C ₂₇₀	kg
VLR110	187-0005	60 LED 7.5W	3000	1125	1097	8°/8°	42°/42°	1.20
VLR120	187-0006	120 LED 15W	3000	2250	1097	8°/8°	42°/42°	1.20
VLR130	187-0007	180 LED 22.5W	3000	3375	1097	8°/8°	42°/42°	3.25
VLR140	187-0008	240 LED 30W	3000	4500	1097	8°/8°	42°/42°	4.00
VLR150	187-0029	300 LED 37.5W	3000	5625	1097	8°/8°	42°/42°	4.75

[LEE]	Part ID	Light source	K	lm*	cd/klm	C ₀ C ₁₈₀	C ₉₀ C ₂₇₀	kg
VLR110	187-0009	60 LED 7.5W	3000	1125	1594	6°/6°	42°/42°	1.20
VLR120	187-0010	120 LED 15W	3000	2250	1594	6°/6°	42°/42°	1.20
VLR130	187-0011	180 LED 22.5W	3000	3375	1594	6°/6°	42°/42°	3.25
VLR140	187-0012	240 LED 30W	3000	4500	1594	6°/6°	42°/42°	4.00
VLR150	187-0030	300 LED 37.5W	3000	5625	1594	6°/6°	42°/42°	4.75

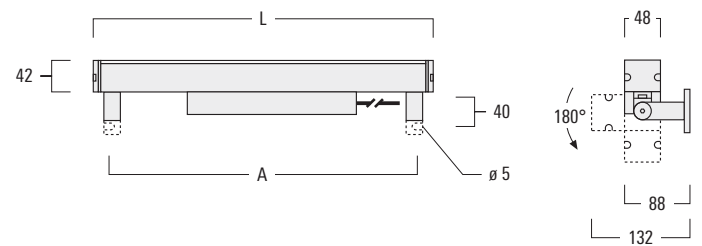

Dimensions	L	A
VLR110	328 mm	287 mm (separate LED driver)
VLR120	628 mm	587 mm
VLR130	928 mm	887 mm
VLR140	1228 mm	1187 mm
VLR150	1528 mm	1487 mm

Other lengths in 100 mm increments available on request
 (228 mm – 1528 mm)

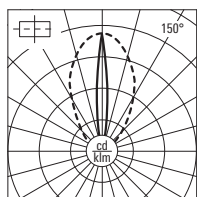

[LE]

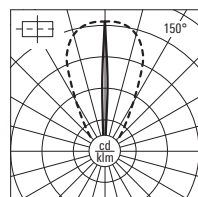

[LEE]



[LA10]

[LA10] Wallwash distribution, asymmetric

[LA10]	Part ID	Light source	K	lm*	Factor**	cd/klm	C ₀ C ₁₈₀	C ₉₀ C ₂₇₀	kg
VLR120	187-0014	120 LED 15W	3000	2250	1.00	959	17°/12°	43°/43°	1.20
VLR130	187-0015	180 LED 22,5W	3000	3375	1.50	959	17°/12°	43°/43°	3.25
VLR140	187-0016	240 LED 30W	3000	4500	2.00	959	17°/12°	43°/43°	4.00

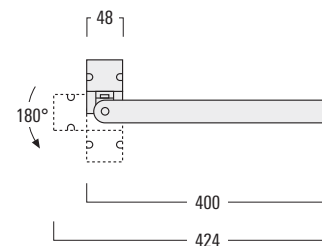
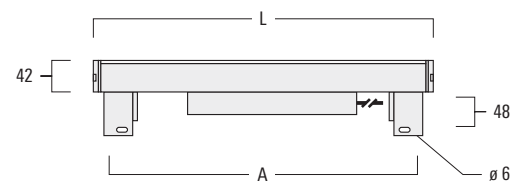

Dimensions	L	A
VLR120	628 mm	587 mm
VLR130	928 mm	887 mm
VLR140	1228 mm	1187 mm

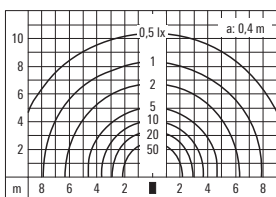

[LA10]

* Nominal lumen output based on LED manufacturers data at 25°C T_J. For rated lumens at 25°C T_q and latest data refer to www.we-ef.com.

** Multiplier for Isolux value

UDN300 SERIES

Wall luminaire, precision beam up, wide or medium beam down.

IP66, Class I. IK10. Marine-grade die-cast aluminium alloy. 5CE superior corrosion protection including PCS hardware. Powdercoat finish in RAL 9004, RAL 9006, RAL 9007 or RAL 9016. Silicone rubber gaskets. Safety glass lens. [P/O] and [P/M] with one contour lens up. Two cable entries.

Integral ECG control gear.

Beam width variation through optional shutter. Colour filters also available.

Light source

QT 100 W

HIT 20-70 W

Light distributions

[P/O] [P/M]

Accessories

■ Optical, page 83



Town hall. Munster (D). Architect: Renken + Szygula.



[P/O] [P/M]

[P/O] Precision beam distribution up, wide beam distribution down

[P/M] Precision beam distribution up, medium beam distribution down



[P/O]	Part ID	Light source	lm	cd/klm	Up	Down	kg
UDN320	112-0008	QT 18 100W/m B15d	1470	225	2°/2°	21°/21°	4.3
	112-0009 [ECG]	HIT-TC-CE 20W G8.5	1700	225	2°/2°	21°/21°	4.4
UDN330	112-0010 [ECG]	HIT-TC-CE 35W G8.5	3500	225	2°/2°	21°/21°	5.3
	112-0011 [ECG]	HIT-TC-CE 70W G8.5	6900	195	2°/2°	21°/21°	5.3

[P/M]	Part ID	Light source	lm	cd/klm	Up	Down	kg
UDN330	112-0012 [ECG]	HIT-TC-CE 35W G8.5	3500	787	2°/2°	9°/9°	5.4
	112-0013 [ECG]	HIT-TC-CE 70W G8.5	6900	1063	2°/2°	7°/7°	5.4

Colour Filter IF	red	green	blue	yellow
UDN320 / UDN330	112-0222	112-0226	112-0227	112-0228

(Shutter/adaptor required for colour or conversion filter)

Shutter/Adaptor for [P/O] and [P/M] distributions

UDN320 / UDN330	112-0070	P	1.5° Beam
	112-0080	P	3.5° Beam
	112-0045	P	4.5° Beam
	112-0084	O or M	Colour filter adaptor

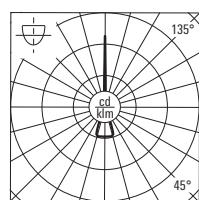

[P/O]

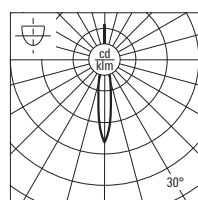

[P/M]

UDN320

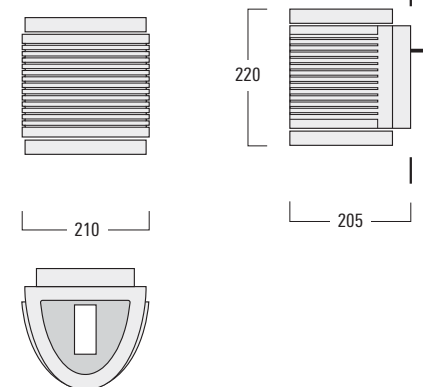

UDN330

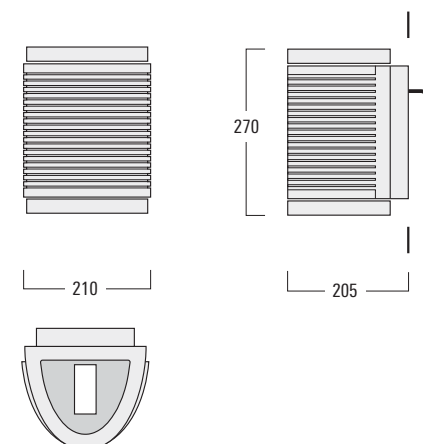

UDN300 SERIES

Wall luminaire, precision or medium beam up and down.

IP66, Class I. IK10. Marine-grade die-cast aluminium alloy. 5CE superior corrosion protection including PCS hardware. Powdercoat finish in RAL 9004, RAL 9006, RAL 9007 or RAL 9016. Silicone rubber gaskets. Safety glass lens. [P/P] with two contour lenses.

Two cable entries.

Integral ECG control gear.

Beam width variation through optional shutter. Colour filters also available.

Light source

QT 100 W

HIT 20-70 W

Light distributions

[P/P] [M/M]

Accessories

■ Optical, page 85



Temple Quay, Bristol (UK). Architect: Landscape Projects.



[P/P]

[M/M]

[P/P] Precision beam distribution up and down

[M/M] Medium beam distribution up and down



[P/P]	Part ID	Light source	lm	cd/klm	Up	Down	kg
UDN320	112-0004	QT 18 100W/m B15d	1470	225	2°/2°	2°/2°	4.4
	112-0005 [ECG]	HIT-TC-CE 20W G8.5	1700	225	2°/2°	2°/2°	4.5
UDN330	112-0006 [ECG]	HIT-TC-CE 35W G8.5	3500	225	2°/2°	2°/2°	5.6
	112-0007 [ECG]	HIT-TC-CE 70W G.5	6900	195	2°/2°	2°/2°	5.6

[M/M]	Part ID	Light source	lm	cd/klm	Up	Down	kg
UDN320	112-0265 [ECG]	HIT-TC-CE 20W G8.5	1700	787	9°/9°	9°/9°	4.5
UDN330	112-0014 [ECG]	HIT-TC-CE 35W G8.5	3500	787	9°/9°	9°/9°	5.3
	112-0015 [ECG]	HIT-TC-CE 70W G8.5	6900	1063	7°/7°	7°/7°	5.3

Colour Filter IF	red	green	blue	yellow
UDN320 / UDN330	112-0222	112-0226	112-0227	112-0228

(Shutter/adaptor required for colour or conversion filter)

Shutter/Adaptor for [P/P] and [M/M] distributions

UDN320 / UDN330	112-0070	P	1.5° Beam
	112-0080	P	3.5° Beam
	112-0045	P	4.5° Beam
	112-0084	M	Colour filter adaptor

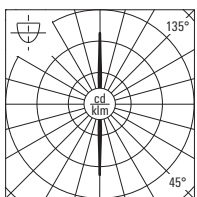

[P/P]

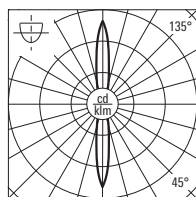

[M/M]

UDN320

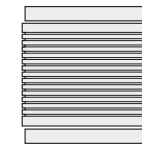

210

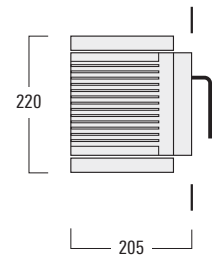
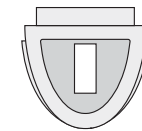

UDN330

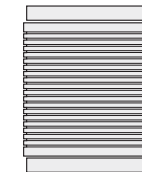

210

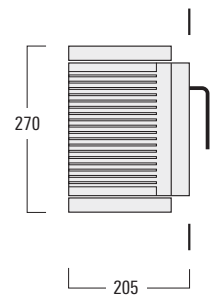
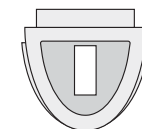

QLS400 SERIES

Wall luminaire, medium or narrow beam distribution, symmetric or side throw, asymmetric down, or combined up and down.

IP66, Class I. IK07. Marine-grade die-cast aluminium alloy. 5CE superior corrosion protection including PCS hardware. Powdercoat finish in RAL 9004, RAL 9006, RAL 9007 or RAL 9016. Silicone rubber gaskets. Safety glass lens. Two cable entries.

Integral EC electronic converter.

Factory installed LED circuit board. LED boards can be easily removed for upgrading. PMMA OLC® LED lenses for superior illumination and glare control.

1-10V or DALI interface on request.

Light source

LED 6-24 W, 3000 K,
for 4000 K refer to www.we-ef.com

Light distributions

[M] [M/M] [E] [E/E] [E/M] [S] [E/S]





[M] [M/M] [E] [E/E]

- [M] Medium beam distribution down
- [M/M] Medium beam distribution up and down
- [E] Narrow beam distribution down
- [E/E] Narrow beam distribution up and down



[M]	Part ID	Light source	K	lm*	cd/klm	Up	Down	kg
QLS410	131-9401	3 LED 6W / 700 mA	3000	738	3505	–	12°/12°	1.9
QLS420	131-9438	6 LED 12W / 700 mA	3000	1476	3505	–	12°/12°	3.1

[M/M]	Part ID	Light source	K	lm*	cd/klm	Up	Down	kg
QLS410	131-9409	2 x 3 LED 12W / 700 mA	3000	2 x 738	3505/3505	12°/12°	12°/12°	1.9
QLS420	131-9446	2 x 6 LED 24W / 700 mA	3000	2 x 1476	3505/3505	12°/12°	12°/12°	3.1

[E]	Part ID	Light source	K	lm*	cd/klm	Up	Down	kg
QLS410	131-0101	3 LED 6W / 700 mA	3000	738	11593	–	6°/6°	1.9
QLS420	131-0097	6 LED 12W / 700 mA	3000	1476	11593	–	6°/6°	3.1

[E/E]	Part ID	Light source	K	lm*	cd/klm	Up	Down	kg
QLS410	131-0103	2 x 3 LED 12W / 700 mA	3000	2 x 738	11593/11593	6°/6°	6°/6°	1.9
QLS420	131-0099	2 x 6 LED 24W / 700 mA	3000	2 x 1476	11593/11593	6°/6°	6°/6°	3.1

QLS410

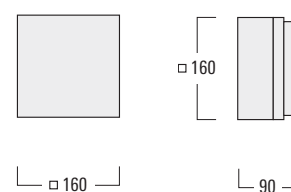

QLS420

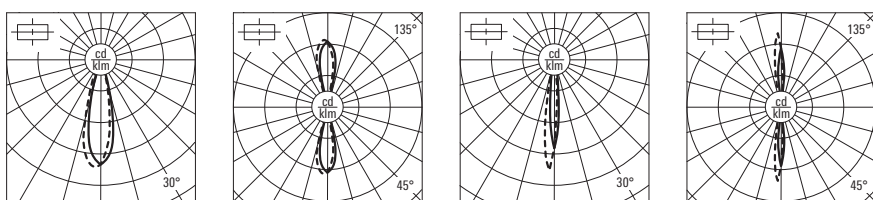
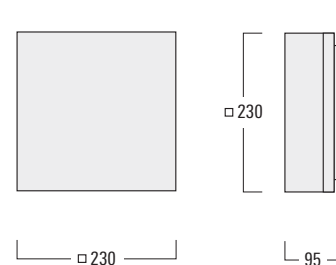

[M] [M/M] [E] [E/E]

* Nominal lumen output based on LED manufacturers data at 85°C T_J. For rated lumens at 25°C T_q and latest data refer to www.we-ef.com.



[E/M]

[E/M] Narrow beam distribution up and medium beam down

[E/M]	Part ID	Light source	K	lm*	cd/klm	Up	Down	kg
QLS410	131-0112	2 x 3 LED 12W / 700 mA	3000	2 x 738	11593/3505	6°/6°	12°/12°	1.9
QLS420	131-0110	2 x 6 LED 24W / 700 mA	3000	2 x 1476	11593/3505	6°/6°	12°/12°	3.1

QLS410

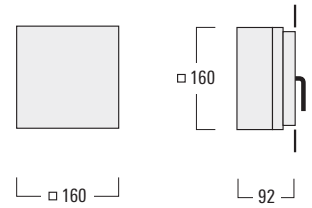

QLS420

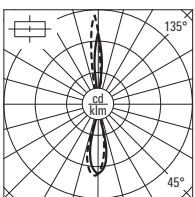
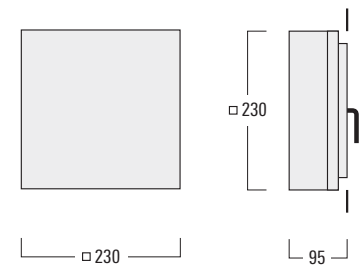

[E/M]



[S]

[E/S]

[S] Side throw distribution down

[E/S] Narrow beam distribution up and side throw down



[S]	Part ID	Light source	K	lm*	cd/klm	Up	Down	kg
QLS410	131-9400	3 LED 6W / 700 mA	3000	738	3123	–	28°/28°	1.9
QLS420	131-9437	6 LED 12W / 700 mA	3000	1476	3123	–	28°/28°	3.1

[E/S]	Part ID	Light source	K	lm*	cd/klm	Up	Down	kg
QLS410	131-0106	2 x 3 LED 12W / 700 mA	3000	2 x 738	11593/3123	6°/6°	28°/28°	1.9
QLS420	131-0108	2 x 6 LED 24W / 700 mA	3000	2 x 1476	11593/3123	6°/6°	28°/28°	3.1

QLS410

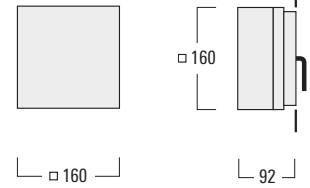

QLS420

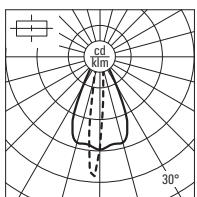
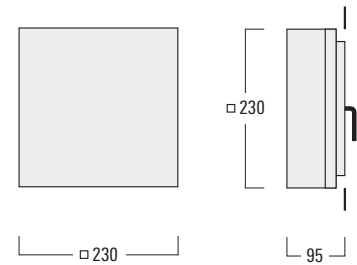

[S]

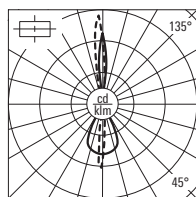

[E/S]

* Nominal lumen output based on LED manufacturers data at 85°C T_J. For rated lumens at 25°C T_q and latest data refer to www.we-ef.com.

VLS400 SERIES

Wall luminaire, medium or narrow beam distribution, symmetric or side throw beam, asymmetric down, or combined up and down.

IP66, Class I. IK07. Marine-grade die-cast aluminium alloy. 5CE superior corrosion protection including PCS hardware. Powdercoat finish in RAL 9004, RAL 9006, RAL 9007 or RAL 9016. Silicone rubber gaskets. Safety glass lens. Two cable entries.

Integral EC electronic converter.

Factory installed LED circuit board. LED boards can be easily removed for upgrading. PMMA OLC® LED lenses for superior illumination and glare control.

1-10V or DALI interface on request.

Light source

LED 6-24 W, 3000 K,
for 4000 K refer to www.we-ef.com

Light distributions

[M] [M/M] [E] [E/E] [E/M] [S] [E/S]





- [M] Medium beam distribution down
- [M/M] Medium beam distribution up and down
- [E] Narrow beam distribution down
- [E/E] Narrow beam distribution up and down



[M]	Part ID	Light source	K	lm*	cd/klm	Up	Down	kg
VLS410	131-9503	3 LED 6W / 700 mA	3000	738	3505	–	12°/12°	1.9
VLS420	131-9153	6 LED 12W / 700 mA	3000	1476	3505	–	12°/12°	3.1

[M/M]	Part ID	Light source	K	lm*	cd/klm	Up	Down	kg
VLS410	131-9513	2 x 3 LED 12W / 700 mA	3000	2 x 738	3505/3505	12°/12°	12°/12°	1.9
VLS420	131-9163	2 x 6 LED 24W / 700 mA	3000	2 x 1476	3505/3505	12°/12°	12°/12°	3.1

[E]	Part ID	Light source	K	lm*	cd/klm	Up	Down	kg
VLS410	131-0137	3 LED 6W / 700 mA	3000	738	11593	–	6°/6°	1.9
VLS420	131-0129	6 LED 12W / 700 mA	3000	1476	11593	–	6°/6°	3.1

[E/E]	Part ID	Light source	K	lm*	cd/klm	Up	Down	kg
VLS410	131-0143	2 x 3 LED 12W / 700 mA	3000	2 x 738	11593/11593	6°/6°	6°/6°	1.9
VLS420	131-0135	2 x 6 LED 24W / 700 mA	3000	2 x 1476	11593/11593	6°/6°	6°/6°	3.1

VLS410

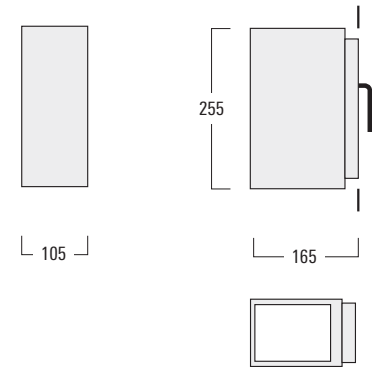

VLS420

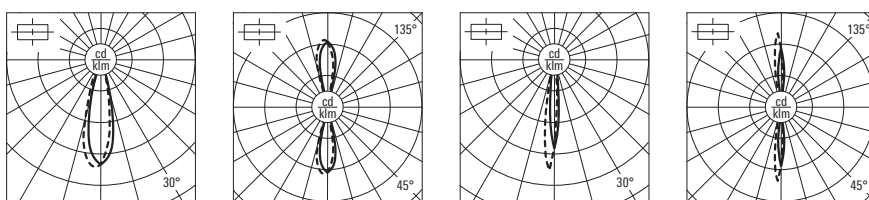
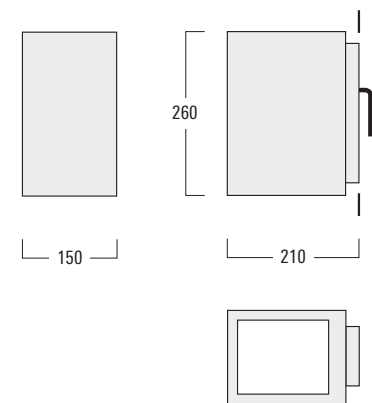

[M] [M/M] [E] [E/E]

* Nominal lumen output based on LED manufacturers data at 85°C T_J. For rated lumens at 25°C T_q and latest data refer to www.we-ef.com.



[E/M]

[E/M] Narrow beam distribution up and medium beam down

[E/M]	Part ID	Light source	K	lm*	cd/klm	Up	Down	kg
VLS410	131-0141	2 x 3 LED 12W / 700 mA	3000	2 x 738	11593/3505	6°/6°	12°/12°	1.9
VLS420	131-0133	2 x 6 LED 24W / 700 mA	3000	2 x 1476	11593/3505	6°/6°	12°/12°	3.1

VLS410

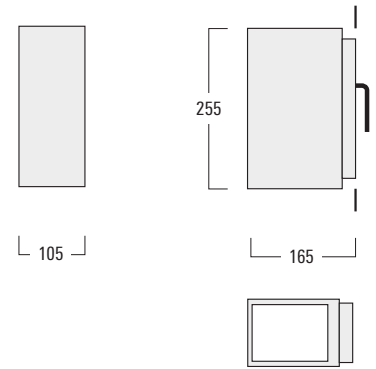

VLS420

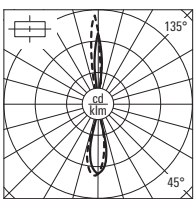
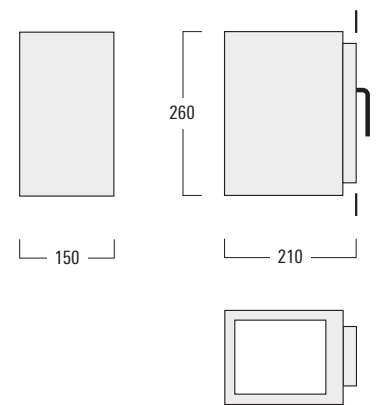

[E/M]



[S] [E/S]

[S] Side throw distribution down
 [E/S] Narrow beam distribution up and side throw down

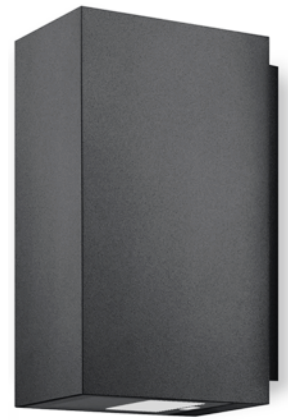

[S]	Part ID	Light source	K	lm*	cd/klm	Up	Down	kg
VLS410	131-9502	3 LED 6W / 700 mA	3000	738	3123	–	28°/28°	1.9
VLS420	131-0145	6 LED 12W / 700 mA	3000	1476	3123	–	28°/28°	3.1

[E/S]	Part ID	Light source	K	lm*	cd/klm	Up	Down	kg
VLS410	131-0139	2 x 3 LED 12W / 700 mA	3000	2 x 738	11593/3123	6°/6°	28°/28°	1.9
VLS420	131-0131	2 x 6 LED 24W / 700 mA	3000	2 x 1476	11593/3123	6°/6°	28°/28°	3.1

VLS410

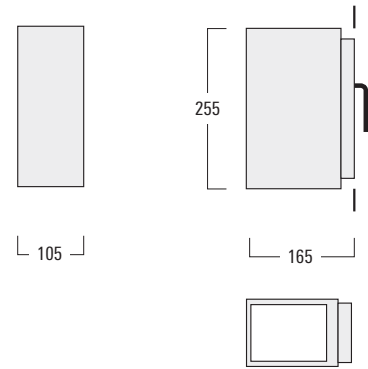

VLS420

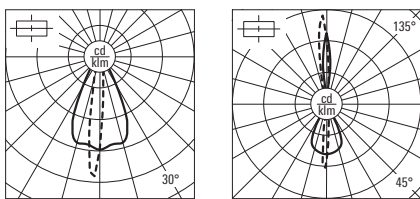
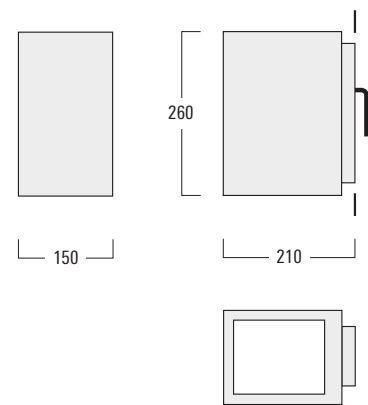

[S] [E/S]

* Nominal lumen output based on LED manufacturers data at 85°C T_J. For rated lumens at 25°C T_q and latest data refer to www.we-ef.com.

SLS400 SERIES

Wall luminaire, medium or narrow beam distribution, symmetric or side throw beam, asymmetric down, or combined up and down.

IP66, Class I. IK07. Marine-grade die-cast aluminium alloy. 5CE superior corrosion protection including PCS hardware. Powdercoat finish in RAL 9004, RAL 9006, RAL 9007 or RAL 9016. Silicone rubber gaskets. Safety glass lens. Two cable entries.

Integral EC electronic converter.

Factory installed LED circuit board. LED boards can be easily removed for upgrading. PMMA OLC® LED lenses for superior illumination and glare control.

1-10V or DALI interface on request.

Light source

LED 6-24 W, 3000 K,
for 4000 K refer to www.we-ef.com

Light distributions

[M] [M/M] [E] [E/E] [E/M] [S] [E/S]





- [M] Medium beam distribution down
- [M/M] Medium beam distribution up and down
- [E] Narrow beam distribution down
- [E/E] Narrow beam distribution up and down



[M]	Part ID	Light source	K	lm*	cd/klm	Up	Down	kg
SLS410	131-9473	3 LED 6W / 700 mA	3000	738	3505	–	12°/12°	3.3
SLS420	131-9533	6 LED 12W / 700 mA	3000	1476	3505	–	12°/12°	5.2

[M/M]	Part ID	Light source	K	lm*	cd/klm	Up	Down	kg
SLS410	131-9483	2 x 3 LED 12W / 700 mA	3000	2 x 738	3505	–	12°/12°	3.3
SLS420	131-9543	2 x 6 LED 24W / 700 mA	3000	2 x 1476	3505	–	12°/12°	5.2

[E]	Part ID	Light source	K	lm*	cd/klm	Up	Down	kg
SLS410	131-0115	3 LED 6W / 700 mA	3000	738	11593	–	6°/6°	3.3
SLS420	131-0121	6 LED 12W / 700 mA	3000	1476	11593	–	6°/6°	5.2

[E/E]	Part ID	Light source	K	lm*	cd/klm	Up	Down	kg
SLS410	131-0119	2 x 3 LED 12W / 700 mA	3000	2 x 738	11593	–	6°/6°	3.3
SLS420	131-0127	2 x 6 LED 24W / 700 mA	3000	2 x 1476	11593	–	6°/6°	5.2

SLS410

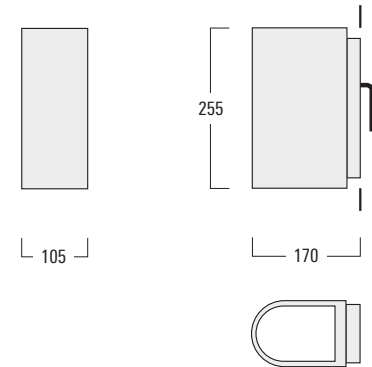

SLS420

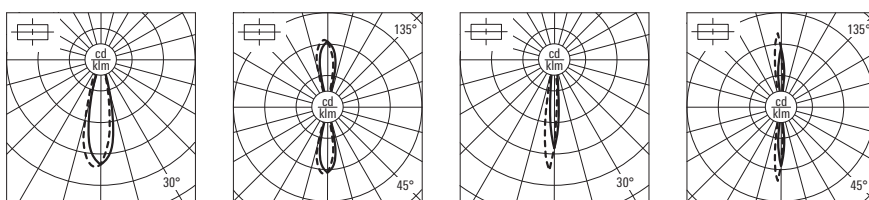
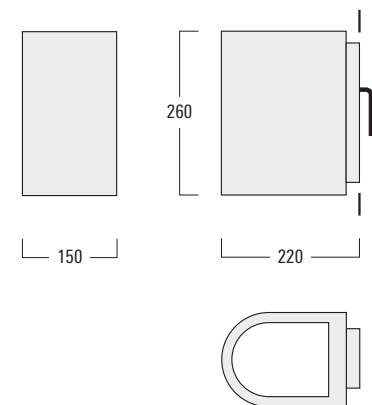

[M] [M/M] [E] [E/E]

* Nominal lumen output based on LED manufacturers data at 85°C T_J. For rated lumens at 25°C T_a and latest data refer to www.we-ef.com.



[E/M]

[E/M] Narrow beam distribution up and medium beam down

[E/M]	Part ID	Light source	K	lm*	cd/klm	Up	Down	kg
SLS410	131-0149	2 x 3 LED 12W / 700 mA	3000	2 x 738	11593/3505	6°/6°	12°/12°	3.3
SLS420	131-0126	2 x 6 LED 24W / 700 mA	3000	2 x 1476	11593/3505	6°/6°	12°/12°	5.2

SLS410

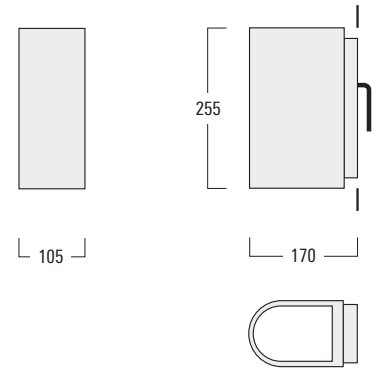

SLS420

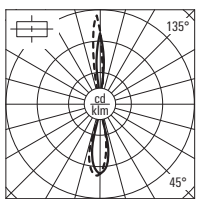
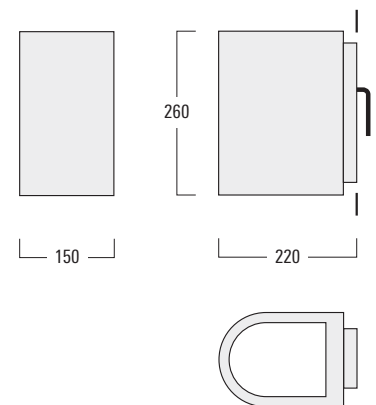

[E/M]



[S]

[E/S]

[S] Side throw distribution down

[E/S] Narrow beam distribution up and side throw down



[S]	Part ID	Light source	K	lm*	cd/klm	Up	Down	kg
SLS410	131-9472	3 LED 6W / 700 mA	3000	738	3123	–	28°/28°	3.3
SLS420	131-0147	6 LED 12W / 700 mA	3000	1476	3123	–	28°/28°	5.2

[E/S]	Part ID	Light source	K	lm*	cd/klm	Up	Down	kg
SLS410	131-0117	2 x 3 LED 12W / 700 mA	3000	2 x 738	11593/3123	6°/6°	28°/28°	3.3
SLS420	131-0123	2 x 6 LED 24W / 700 mA	3000	2 x 1476	11593/3123	6°/6°	28°/28°	5.2

SLS410

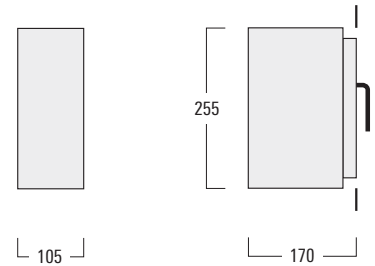

SLS420

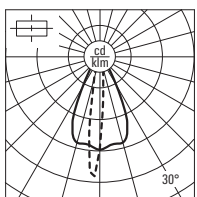
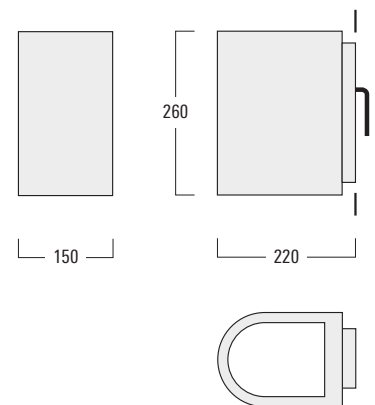

[S]

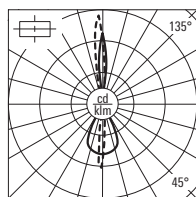

[E/S]

* Nominal lumen output based on LED manufacturers data at 85°C T_J. For rated lumens at 25°C T_q and latest data refer to www.we-ef.com.

OLV300 SERIES

Wall luminaire, medium or very narrow beam distribution 'sharp cut-off', symmetric.

IP65, Class I. IK08. Marine-grade die-cast aluminium alloy. 5CE superior corrosion protection including PCS hardware. Powdercoat finish in RAL 9004, RAL 9006, RAL 9007 or RAL 9016. Silicone rubber gaskets. Safety glass lens. Two cable entries.

Integral EC electronic converter.

Factory installed LED circuit board. LED boards can be easily removed for upgrading. PMMA OLC® LED lenses for superior illumination and glare control.

Can be mounted up or down.

Light source

LED 12-36 W, 3000 K,
for 4000 K refer to www.we-ef.com

Light distributions

[M] [EES]



Le Meridien. New Delhi (IN). Architect & Lighting design: Bobby Mukherjee & Associates.



[M] [EES]

[M] Medium beam distribution, symmetric
 [EES] Very narrow beam distribution, symmetric, 'sharp cut-off'



[M]	Part ID	Light source	K	lm*	cd/klm	C ₀ C ₁₈₀	kg
OLV330	132-0522	12 LED 12W / 350 mA	3000	1614	2196	16°/16°	6.6
	132-0532	12 LED 18W / 500 mA	3000	2217	2196	16°/16°	6.6
OLV340	132-0542	24 LED 24W / 350 mA	3000	3228	2196	16°/16°	11.4
	132-0552	24 LED 36W / 500 mA	3000	4435	2196	16°/16°	11.4

[EES]	Part ID	Light source	K	lm*	cd/klm	C ₀ C ₁₈₀	kg
OLV330	132-0524	12 LED 12W / 350 mA	3000	1614	20389	5°/5°	6.6
	132-0534	12 LED 18W / 500 mA	3000	2217	20389	5°/5°	6.6
OLV340	132-0544	24 LED 24W / 350 mA	3000	3228	20389	5°/5°	11.4
	132-0554	24 LED 36W / 500 mA	3000	4435	20389	5°/5°	11.4

OLV330

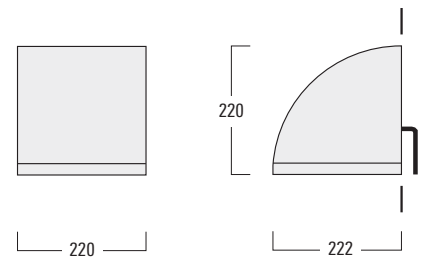

OLV340

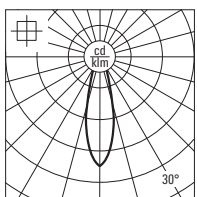
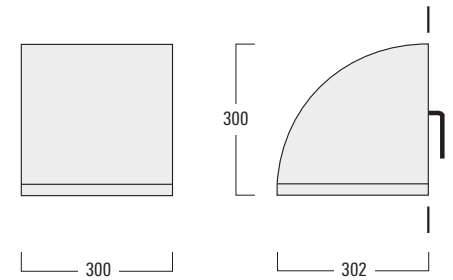

[M]

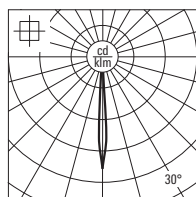

[EES]

* Nominal lumen output based on LED manufacturers data at 85°C T_j. For rated lumens at 25°C T_q and latest data refer to www.we-ef.com.

OLV300 SERIES

Wall luminaire, streetlighting or forward throw distribution, asymmetric.

IP65, Class I. IK08. Marine-grade die-cast aluminium alloy. 5CE superior corrosion protection including PCS hardware. Powdercoat finish in RAL 9004, RAL 9006, RAL 9007 or RAL 9016. Silicone rubber gaskets. Safety glass lens. Two cable entries.

Integral EC electronic converter.

Factory installed LED circuit board. LED boards can be easily removed for upgrading. PMMA OLC® LED lenses for superior illumination and glare control.

Can be mounted up or down.

Light source

LED 12-48 W, 3000 K,
for 4000 K refer to www.we-ef.com



Light distributions

[S70] [A60] [R65]

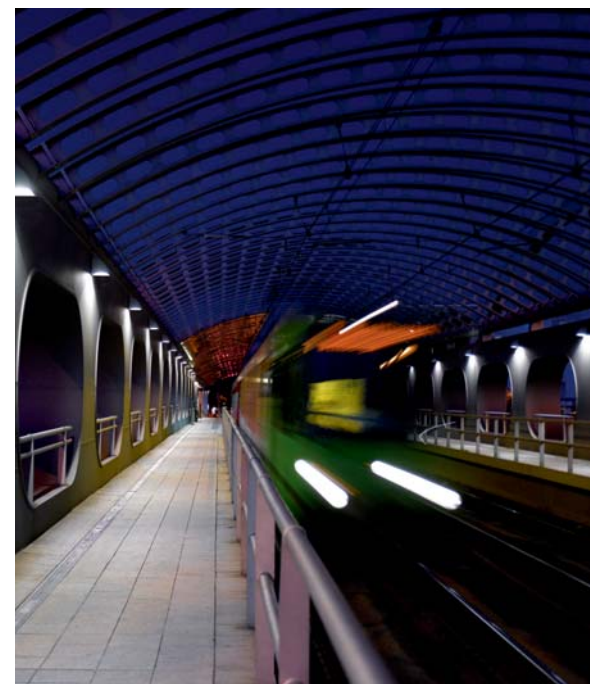

Noltemeyer Bridge. Hannover (D)



[S70] [A60] [R65]

[S70] Streetlighting distribution

[A60] Forward throw distribution, asymmetric

[R65] Rectangular forward throw distribution



[S70]	Part ID	Light source	K	lm*	Factor**	kg
OLV334	132-0526	12 LED 12W / 350 mA	3000	1614	1.00	6.6
	132-0536	12 LED 24W / 700 mA	3000	2951	1.83	6.6
OLV344	132-0546	24 LED 24W / 350 mA	3000	3228	2.00	11.4
	132-0556	24 LED 48W / 700 mA	3000	5903	3.66	11.4

[A60]	Part ID	Light source	K	lm*	Factor**	kg
OLV334	132-0530	12 LED 12W / 350 mA	3000	1614	1.00	6.6
	132-0540	12 LED 24W / 700 mA	3000	2951	1.83	6.6
OLV344	132-0550	24 LED 24W / 350 mA	3000	3228	2.00	11.4
	132-0560	24 LED 48W / 700 mA	3000	5903	3.66	11.4

[R65]	Part ID	Light source	K	lm*	Factor**	kg
OLV334	132-0528	12 LED 12W / 350 mA	3000	1614	1.00	6.6
	132-0538	12 LED 24W / 700 mA	3000	2951	1.83	6.6
OLV344	132-0548	24 LED 24W / 350 mA	3000	3228	2.00	11.4
	132-0558	24 LED 48W / 700 mA	3000	5903	3.66	11.4

OLV334

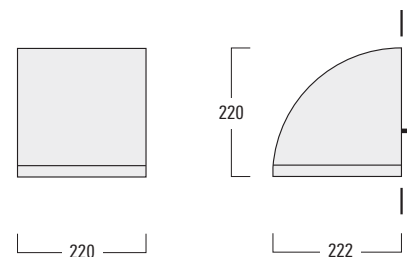

OLV344

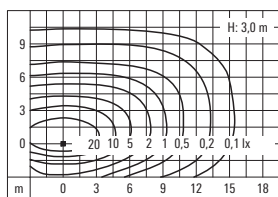
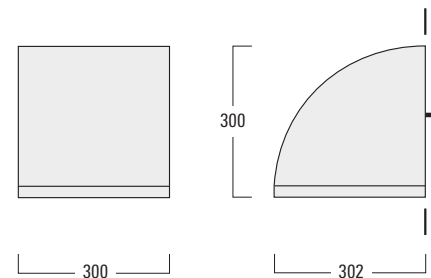

[S70]

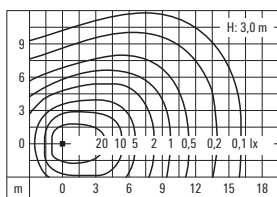

[A60]

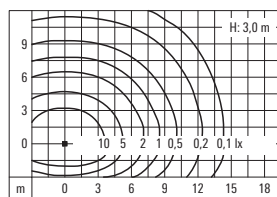

[R65]

* Nominal lumen output based on LED manufacturers data at 85°C T_J. For rated lumens at 25°C T_q and latest data refer to www.we-ef.com.

** Multiplier for Isolux value

OLV300 SERIES

Wall luminaire, medium or very narrow beam distribution, symmetric.

IP65, Class I. IK08. Marine-grade die-cast aluminium alloy. 5CE superior corrosion protection including PCS hardware. Powdercoat finish in RAL 9004, RAL 9006, RAL 9007 or RAL 9016. Silicone rubber gaskets. Safety glass lens. Anodised aluminium reflector.

Two cable entries.

Integral HPF or ECG control gear.

Can be mounted up or down.

Light source
HIT 35-150 W

Light distributions
[M] [EE]



Hotel Dream Castle Eurodisney. Paris (F). Architect: D. Paysage, Paris.



[M] [EE]

[M] Medium beam distribution, symmetric
 [EE] Very narrow beam distribution, symmetric



[M]	Part ID	Light source	lm	cd/klm	C ₀ C ₁₈₀	kg
OLV330	132-0330 [ECG]	HIT-TC-CE 35W G8,5	3500	2214	12°/12°	5.2
	132-0216 [HPF]	HIT-TC-CE 70W G8,5	6900	2046	13°/13°	6.3
OLV340	132-0331 [ECG]	HIT-CE 70W G12	7300	1643	20°/20°	7.8
	132-0083 [HPF]	HIT-CE 150W G12	15000	1280	23°/23°	9.4

[EE]	Part ID	Light source	lm	cd/klm	C ₀ C ₁₈₀	kg
OLV330	132-0332 [ECG]	HIT-TC-CE 35W G8,5	3500	20113	3°/3°	5.2
	132-0220 [HPF]	HIT-TC-CE 70W G8,5	6900	13527	4°/4°	6.3
OLV340	132-0333 [ECG]	HIT-CE 70W G12	7300	29929	3°/3°	7.8
	132-0091 [HPF]	HIT-CE 150W G12	15000	18752	4°/4°	9.4

Colour Filter IF	red	green	blue	yellow
OLV330	132-0458	132-0459	132-0460	132-0403
OLV340	132-0461	132-0462	132-0463	132-0464

Lenses IO	IO-360 flood lens	IO-180 linear spread lens
OLV330	132-0319	132-0467
OLV340	132-0294	132-0438

OLV330

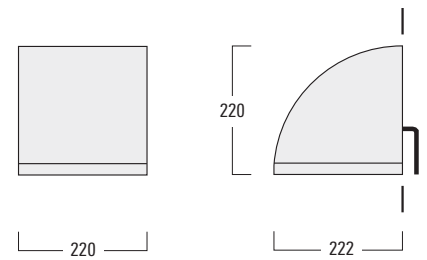

OLV340

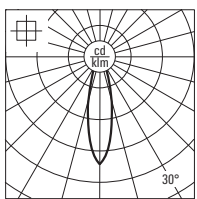
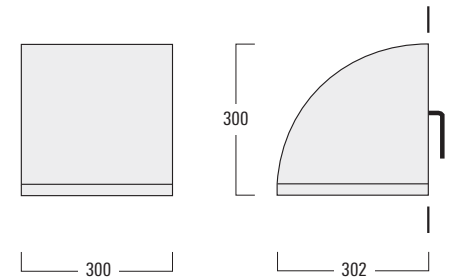

[M]

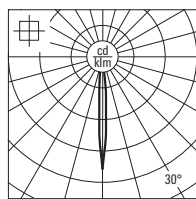

[EE]

OLV300 SERIES

Wall luminaire, side or forward throw distribution, asymmetric.

IP65, Class I. IK08. Marine-grade die-cast aluminium alloy. 5CE superior corrosion protection including PCS hardware. Powdercoat finish in RAL 9004, RAL 9006, RAL 9007 or RAL 9016. Silicone rubber gaskets. Safety glass lens. Anodised aluminium reflector.

Two cable entries.

Integral HPF or ECG control gear.

Sideways and rearward cut-off shields on request.

Can be mounted up or down.

Light source
HIT 35-150 W

Light distributions
[S] [A]



Endeavour Bridge, Whitianga Waterways. Whitianga (NZ). Lighting design: Airey Consultants / Modus Lighting.

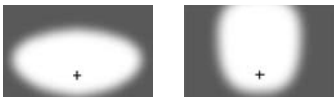

[S]

[A]

[S] Side throw distribution

[A] Forward throw distribution, asymmetric



[S]	Part ID	Light source	lm	Factor*	kg
OLV330	132-0334 [ECG]	HIT-CE 35W G12	3600	0.49	5.5
	132-0335 [HPF]	HIT-CE 70W G12	7300	1.00	6.6
OLV340	132-0336 [ECG]	HIT-CE 70W G12	7300	1.00	8.1
	132-0241 [HPF]	HIT-CE 150W G12	15000	2.05	9.7

[A]	Part ID	Light source	lm	Factor*	kg
OLV330	132-0337 [ECG]	HIT-CE 35W G8.5	3500	0.51	5.3
	132-0226 [HPF]	HIT-CE 70W G8.5	6900	1.01	6.4
OLV340	132-0339 [ECG]	HIT-DE-CE 70W RX7s	6800	1.00	7.9
	132-0254 [HPF]	HIT-DE-CE 150W RX7s	14500	2.13	9.5

OLV330

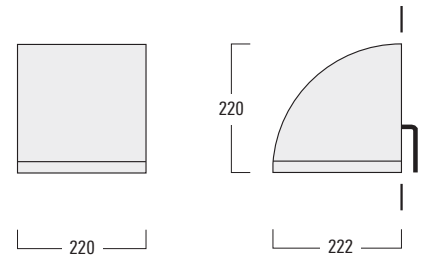

OLV340

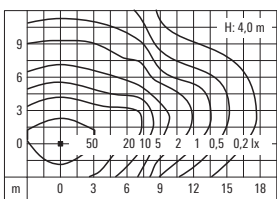
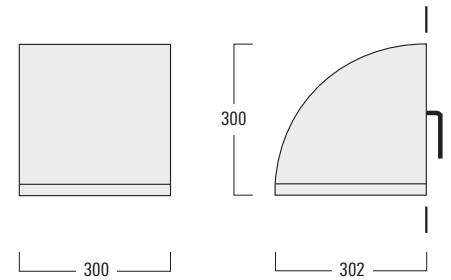

[S]

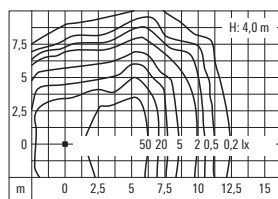

[A]

* Multiplier for Isolux value

PIA200 SERIES

Facade and ceiling washlight, side and forward throw distribution, asymmetric.

IP66, Class I. IK08. Marine-grade die-cast aluminium alloy. 5CE superior corrosion protection including PCS hardware. Powdercoat finish in RAL 9004, RAL 9006, RAL 9007 or RAL 9016. Silicone rubber gaskets. Non-reflecting safety glass lens.

PIA230: $\pm 30^\circ$ tilt, PIA240: $+15^\circ/-30^\circ$ tilt.

Integral EC electronic converter. Factory installed LED circuit board. LED boards can be easily removed for upgrading. PMMA OLC® LED lenses for superior illumination and glare control.

Can be mounted up or down.

Light source

LED 24-72 W, 3000 K,
for 4000 K refer to www.we-ef.com

Light distributions

[S65] [A60] [R65]



McCarran International Airport, Terminal 3. Las Vegas, Nevada (USA). Lighting design: Horton Lees Brogden Lighting Design.



[S65] [A60] [R65]

[S65] Streetlighting distribution

[A60] Forward throw distribution, asymmetric

[R65] Rectangular forward throw distribution



[S65]	Part ID	Light source	K	lm*	Factor**	kg
PIA230	108-1660	12 LED 24W / 700 mA	3000	2951	1.00	8.5
	108-1747	18 LED 36W / 700 mA	3000	4427	1.50	8.5
PIA240	108-1649	18 LED 54W / 1050 mA	3000	7020	2.38	12.7
	108-1759	24 LED 72W / 1050 mA	3000	9360	3.17	12.7

[A60]	Part ID	Light source	K	lm*	Factor**	kg
PIA230	108-1666	12 LED 24W / 700 mA	3000	2951	1.00	8.5
	108-1751	18 LED 36W / 700 mA	3000	4427	1.50	8.5
PIA240	108-1655	18 LED 54W / 1050 mA	3000	7020	2.38	12.7
	108-1763	24 LED 72W / 1050 mA	3000	9360	3.17	12.7

[R65]	Part ID	Light source	K	lm*	Factor**	kg
PIA230	108-1664	12 LED 24W / 700 mA	3000	2951	1.00	8.5
	108-1749	18 LED 36W / 700 mA	3000	4427	1.50	8.5
PIA240	108-1653	18 LED 54W / 1050 mA	3000	7020	2.38	12.7
	108-1761	24 LED 72W / 1050 mA	3000	9360	3.17	12.7

Flood lens	IO-360***
for PIA230 [A60]	108-1851
for PIA240 [A60]	108-1852

PIA230

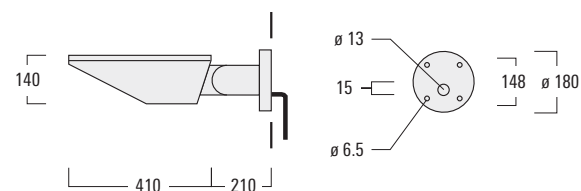

PIA240

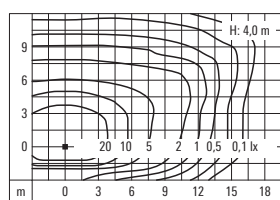
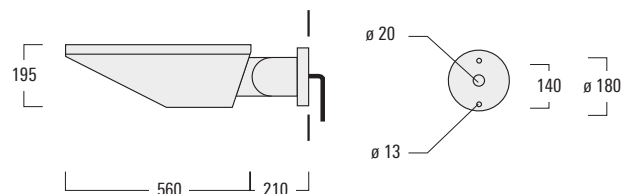

[S65]

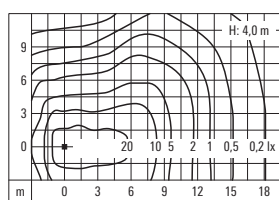

[A60]

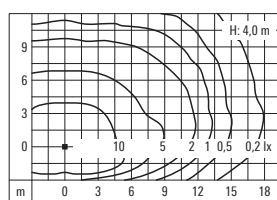

[R65]

* Nominal lumen output based on LED manufacturers data at 85°C T_j. For rated lumens at 25°C T_q and latest data refer to www.we-ef.com.

** Multiplier for Isolux value

*** Ideal for uniform ceiling washing applications.

PIA200 SERIES

Facade and ceiling washlight, side or forward throw distribution, asymmetric.

IP66, Class I. IK08. Marine-grade die-cast aluminium alloy. 5CE superior corrosion protection including PCS hardware. Powdercoat finish in RAL 9004, RAL 9006, RAL 9007 or RAL 9016. Silicone rubber gaskets. Safety glass lens. Anodised aluminium reflector.

PIA230: $\pm 30^\circ$ tilt, PIA240: $+15^\circ/-30^\circ$ tilt.

Integral HPF or ECG control gear.

Can be mounted up or down.

Light source
HIT 20-250 W

Light distributions
[S] [A]



Shopping Center Cap Sud. Avignon (F). Lighting design: Acrobat, Saint Etienne.

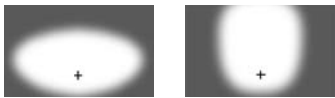

[S]

[A]

[S] Side throw distribution

[A] Forward throw distribution, asymmetric



[S]	Part ID	Light source	lm	Factor*	kg
PIA230	108-0755 [ECG]	HIT-CE 20W G12	1650	0.11	8.5
	108-0417 [ECG]	HIT-CE 35W G12	3600	0.25	8.5
	108-0418 [ECG]	HIT-CE 70W G12	7300	0.50	8.5
PIA240	108-0450 [ECG]	HIT-CE 150W E40	14500	1.00	12.7
	108-0452 [HPF]	HIT-CE 250W E40	26000	1.79	15.3

[A]	Part ID	Light source	lm	Factor*	kg
PIA230	108-0758 [ECG]	HIT-CE 20W G12	1650	0.11	8.5
	108-0419 [ECG]	HIT-CE 35W G12	3600	0.25	8.5
	108-0420 [ECG]	HIT-CE 70W G12	7300	0.50	8.5
PIA240	108-0458 [ECG]	HIT-DE-CE 150W RX7s	14500	1.00	12.9
	108-0211 [HPF]	HIT-DE-CE 250W Fc2	25000	1.72	15.5

Rearward cut-off shield for [S] version,
with side throw distribution

PIA230	108-0427
PIA240	108-0469

Sidewards cut-off shield for [A] versions,
with forward throw distribution

PIA230	108-0428
PIA240	108-0470

PIA230

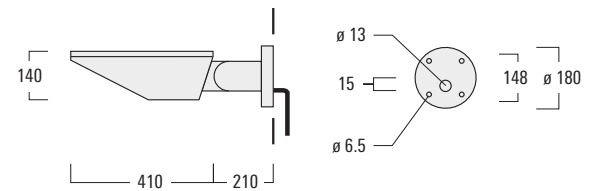

PIA240

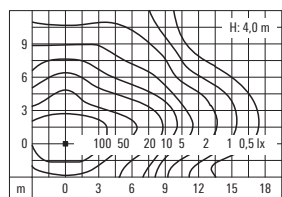
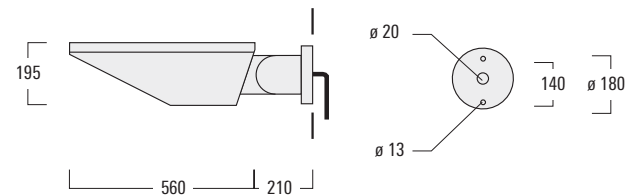

[S]

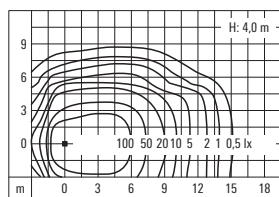

[A]

* Multiplier for Isolux value

DLO200 / DLG200 SERIES

Wall luminaires, diffused distribution.

IP55, Class I. IK10. Marine-grade die-cast aluminium alloy. 5CE superior corrosion protection including PCS hardware. Powdercoat finish in RAL 9004, RAL 9006, RAL 9007 or RAL 9016. Silicone rubber gasket. Polycarbonate lens. Two cable entries.

Integral EC electronic converter.

Factory installed LED circuit board. LED boards can be easily removed for upgrading.

Light source

LED 12-24 W, 3000 K,

for 4000 K refer to www.we-ef.com

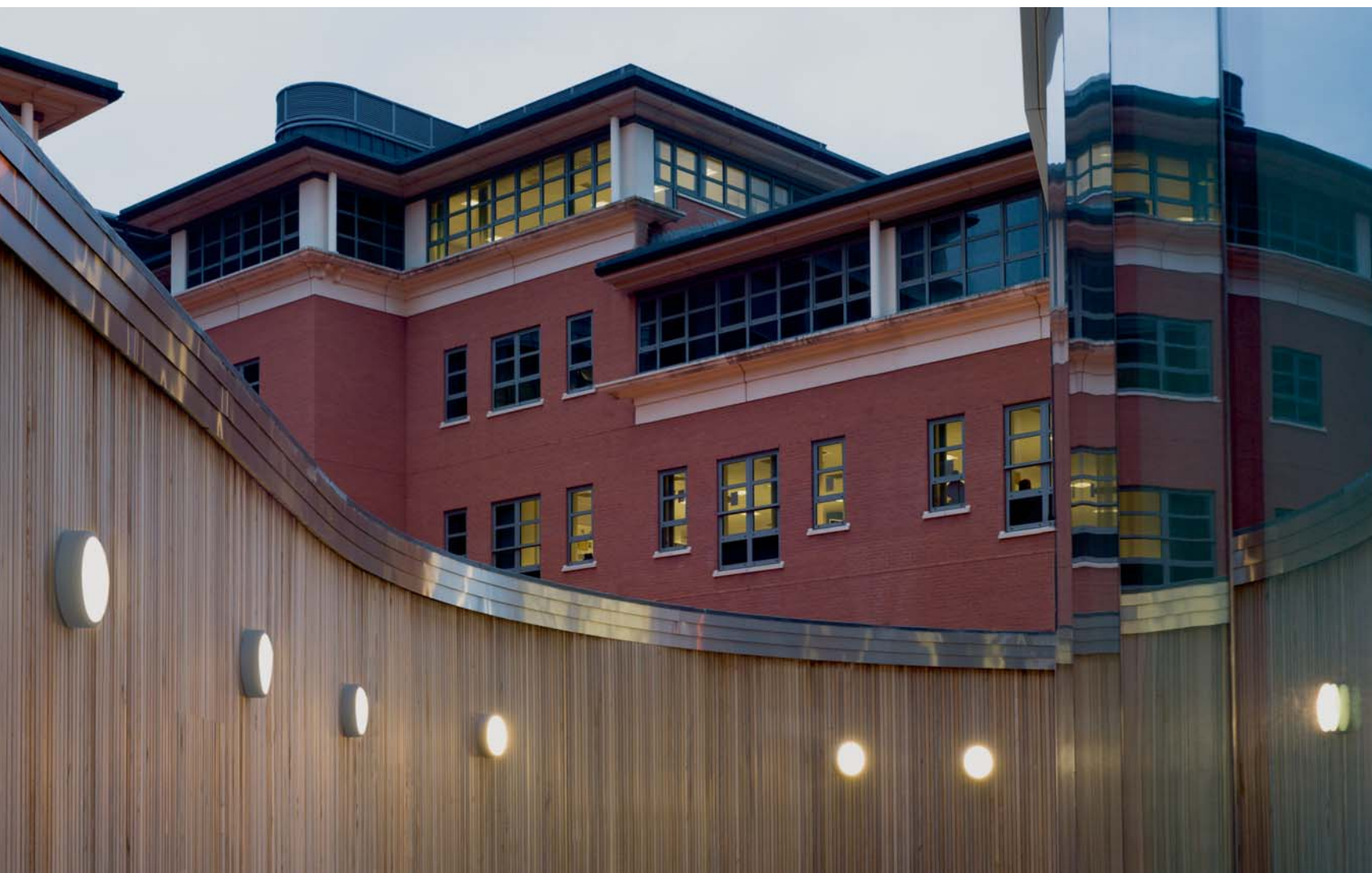

Temple Quay, Bristol (UK). Architect: Landscape Projects.



	Part ID	Light source	K	lm*	Factor**	kg	
	DLO229	195-9521	LED-FT 12W	3000	1860	1.00	2.0
	DLO239	195-9536	LED-FT 24W	3000	3795	2.04	3.5
	DLG229	195-9524	LED-FT 12W	3000	1860	1.00	2.1
	DLG239	195-9539	LED-FT 24W	3000	3795	2.04	3.6

DLO229

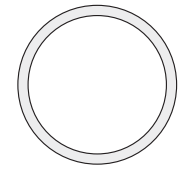

ø 263

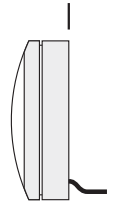

86

DLO239

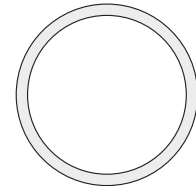

ø 350

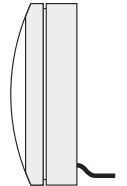

127

DLG229

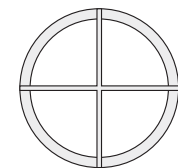

ø 263

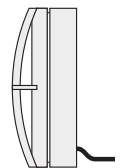

100

DLG239

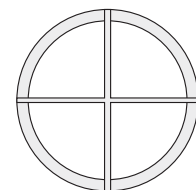

ø 350

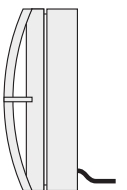

140

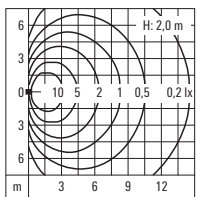

* Nominal lumen output based on LED manufacturers data at 25°C T_c. For rated lumens at 25°C T_q and latest data refer to www.we-ef.com.
 ** Multiplier for Isolux value

XLO200 SERIES

Wall luminaire, diffused distribution.

IP55, Class I, IK10. Marine-grade die-cast aluminium alloy. 5CE superior corrosion protection including PCS hardware. Powdercoat finish in RAL 9004, RAL 9006, RAL 9007 or RAL 9016. Silicone rubber gasket. Polycarbonate lens. Two cable entries.

Integral EC electronic converter.

Factory installed LED circuit board. LED boards can be easily removed for upgrading.

Light source

LED 12-24 W, 3000 K,

for 4000 K refer to www.we-ef.com





	Part ID	Light source	K	lm*	Factor**	kg	
	XL0229	195-9533	LED-FT 12W	3000	1860	1.00	3.2
	XL0239	195-9548	LED-FT 24W	3000	3795	2.04	7.0

XL0229

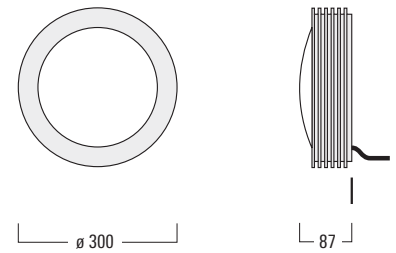

XL0239

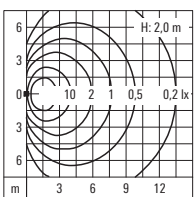
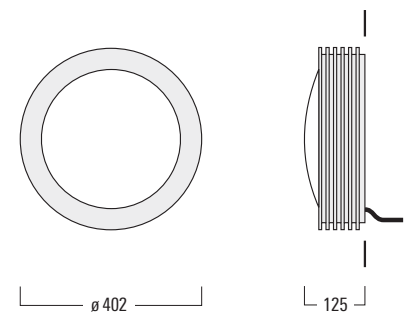

* Nominal lumen output based on LED manufacturers data at 25°C T_c. For rated lumens at 25°C T_q and latest data refer to www.we-ef.com.
 ** Multiplier for Isolux value

IOS® Beam distributions for ceiling luminaires

- [B] wide beam, symmetric
- [BD] wide beam, symmetric – Darklight
- [M] medium beam, symmetric
- [EE] very narrow beam, symmetric
- [EES] very narrow beam, symmetric, 'sharp cut-off'
- [A20] wallwash, asymmetric

Ceiling luminaires



DOC200 Gimbal LED 116



DOC200 Gimbal 118



DOC200 LED 120



DOC200 124



DAC200 Gimbal LED 126



DAC200 LED 128



DAC200 130



ACCESSORIES

- Mounting 132
- Optical 134

DOC200 GIMBAL SERIES

Downlight, wide, medium, very narrow or very narrow beam distribution 'sharp cut-off', symmetric, or wallwash distribution, asymmetric. Tilt and rotatable.

IP66, Class I. IK07. Marine-grade, die-cast aluminium alloy. 5CE superior corrosion protection including PCS hardware. Powdercoat finish in RAL 9004, RAL 9006, RAL 9007 or RAL 9016. Silicone rubber gasket. Safety glass lens, hinged. Frame with safety catch. Two cable entries.

EC electronic converter in thermally separated compartment.

Factory installed LED circuit board. LED boards can be easily removed for upgrading. PMMA LED lens array. 30° tilt and 355° rotatable.

A pre-installation blockout, proud or flush, is available and recommended for mounting in concrete ceilings. To be ordered separately.

Light source
LED 18 W, 3000 K,
for 4000 K refer to www.we-ef.com

Light distributions
[B] [M] [EE] [EES] [A20]

Accessories
■ Mounting, page 132
■ Optical, page 134



White City. London (UK). Lighting design: Speirs & Majors Associates.

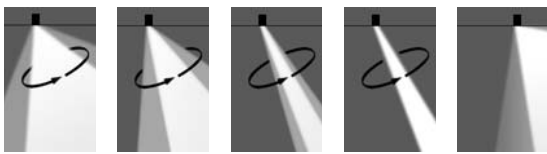

- [B] Wide beam distribution, symmetric
- [M] Medium beam distribution, symmetric,
- [EE] Very narrow beam distribution, symmetric
- [EES] Very narrow beam distribution, symmetric, 'sharp cut-off'
- [A20] Wallwash distribution, asymmetric



[B]	Part ID	Light source	K	lm*	cd/klm	C ₀ C ₁₈₀	kg	
DOC240-GB	134-1344	12 LED 18W / 500 mA	3000	2217	920	25°/25°	5.5	
[M]	Part ID	Light source	K	lm*	cd/klm	C ₀ C ₁₈₀	kg	
DOC240-GB	134-1253	12 LED 18W / 500 mA	3000	2217	2196	16°/16°	5.5	
[EE]	Part ID	Light source	K	lm*	cd/klm	C ₀ C ₁₈₀	kg	
DOC240-GB	134-1347	12 LED 18W / 500 mA	3000	2217	7191	7°/7°	5.5	
[EES]	Part ID	Light source	K	lm*	cd/klm	C ₀ C ₁₈₀	kg	
DOC240-GB	134-1256	12 LED 18W / 500 mA	3000	2217	20389	5°/5°	5.5	
[A20]	Part ID	Light source	K	lm*	cd/klm	C ₀ C ₁₈₀	C ₉₀ C ₂₇₀	kg
DOC240-GB	134-1611	12 LED 18W / 500 mA	3000	2217	787	15°/16°	35°/35°	5.5

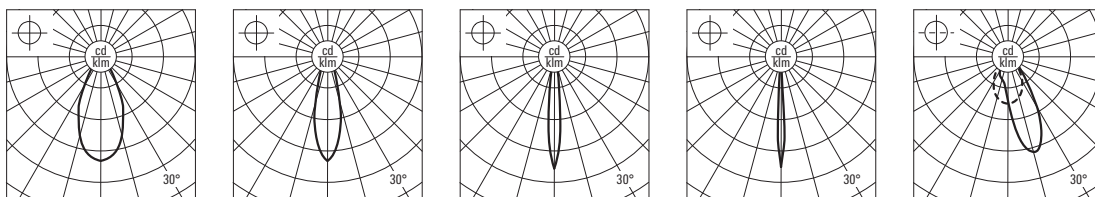
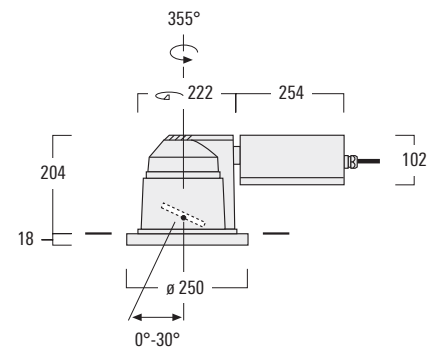

[B] [M] [EE] [EES] [A20]

* Nominal lumen output based on LED manufacturers data at 85°C T_j. For rated lumens at 25°C T_a and latest data refer to www.we-ef.com.

DOC200 GIMBAL SERIES

Downlight, medium or very narrow beam distribution, symmetric. Tilt and rotatable.

IP66, Class I, IK 07. Marine-grade, die-cast aluminium alloy. 5CE superior corrosion protection including PCS hardware. Powdercoat finish in RAL 9004, RAL 9006, RAL 9007 or RAL 9016. Silicone rubber gasket. Safety glass lens, hinged. Frame with safety catch. Two cable entries.

Anodised aluminium reflector. 25° tilt and 355° rotatable.

ECG control gear in thermally separated compartment.

A pre-installation blockout, proud or flush, is available and recommended for mounting in concrete ceilings. To be ordered separately.

Light source
HIT 20-70 W

Light distributions
[M] [EE]

Accessories

- Mounting, page 132
- Optical, page 134

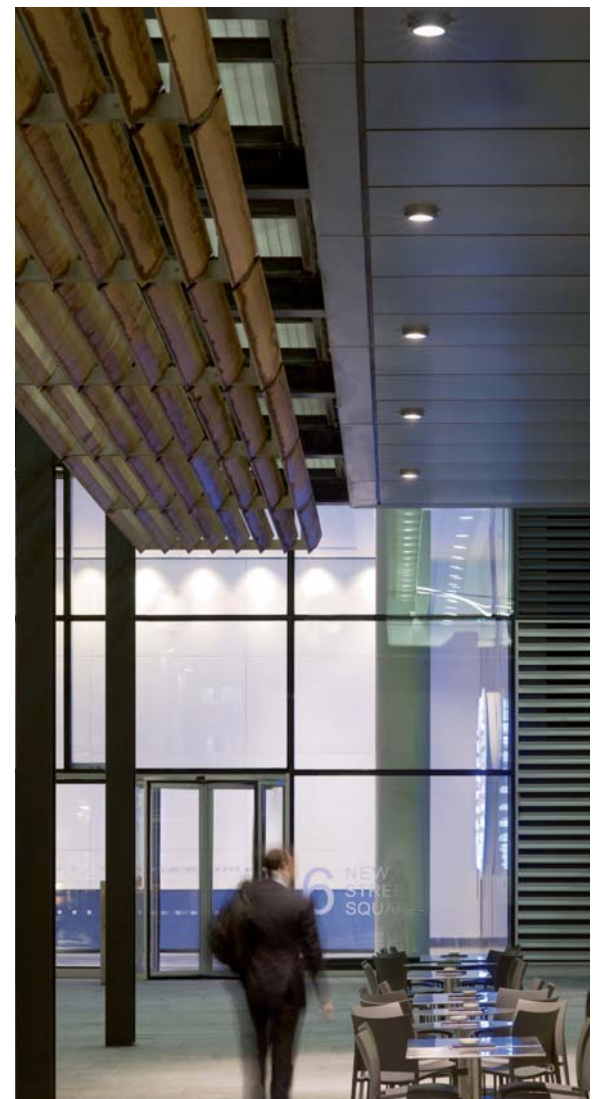

New Street Square. London (UK). Architect: Bennett Associates, London. Lighting design: Speirs & Majors Associates, London.

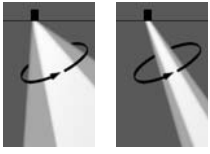

[M] [EE]

[M] Medium beam distribution, symmetric
 [EE] Very narrow beam distribution, symmetric



[M]	Part ID	Light source	lm	cd/klm	C ₀ C ₁₈₀	kg
DOC240-GB	134-1155 [ECG]	HIT-TC-CE 20W G8.5	1700	2145	12°/12°	6.8
	134-1156 [ECG]	HIT-TC-CE 35W G8.5	3500	1441	18°/18°	6.8
	134-1157 [ECG]	HIT-TC-CE 70W G8.5	6900	1296	17°/17°	6.8

[EE]	Part ID	Light source	lm	cd/klm	C ₀ C ₁₈₀	kg
DOC240-GB	134-1158 [ECG]	HIT-TC-CE 20W G8.5	1700	10244	4°/4°	6.8
	134-1159 [ECG]	HIT-TC-CE 35W G8.5	3500	11214	4°/4°	6.8
	134-1160 [ECG]	HIT-TC-CE 70W G8.5	6900	7479	4°/4°	6.8

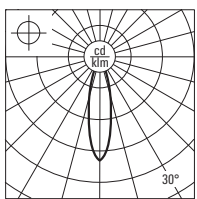
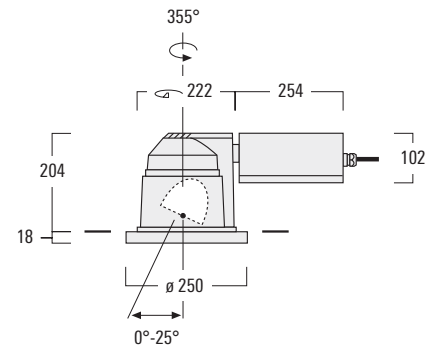

[M]

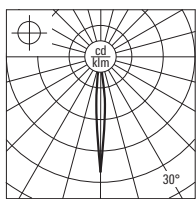

[EE]

DOC200 SERIES

Downlight, wide, medium, very narrow beam or very narrow beam distribution 'sharp cut-off', symmetric.

IP66, Class I. IK07. Marine-grade, die-cast aluminium alloy. 5CE superior corrosion protection including PCS hardware. Powdercoat finish in RAL 9004, RAL 9006, RAL 9007 or RAL 9016. Silicone rubber gasket. Safety glass lens, hinged. Frame with safety catch. Two cable entries.

EC electronic converter in thermally separated compartment.

Factory installed LED circuit board. LED boards can be easily removed for upgrading. PMMA LED lens array.

A pre-installation blockout, proud or flush, is available and recommended for mounting in concrete ceilings. To be ordered separately.

Light source

LED 12-48 W, 3000 K,
for 4000 K refer to www.we-ef.com

Light distributions

[B] [M] [EE] [EES]

Accessories

- Mounting, page 132
- Optical, page 134



Metro station Breslauer Platz, Köln (D). Architect: Architekturbüro Bueder + Wenzel Architekten, Köln. Lighting design: Licht Kunst Licht, Bonn/Berlin.



[B] [M] [EE] [EES]

- [B] Wide beam distribution, symmetric
- [M] Medium beam distribution, symmetric
- [EE] Very narrow beam distribution, symmetric
- [EES] Very narrow beam distribution, symmetric, 'sharp cut-off'



[B]	Part ID	Light source	K	lm*	cd/klm	C ₀ C ₁₈₀	kg
DOC110	134-1625	6 LED 12W / 700 mA	3000	1476	934	25°/25°	1.3
DOC220	134-1332	12 LED 24W / 700 mA	3000	2951	920	25°/25°	2.0
DOC240	134-1396	24 LED 48W / 700 mA	3000	5903	934	25°/25°	2.0

[M]	Part ID	Light source	K	lm*	cd/klm	C ₀ C ₁₈₀	kg
DOC110	134-1627	6 LED 12W / 700 mA	3000	1476	2196	16°/16°	1.3
DOC220	134-1210	12 LED 24W / 700 mA	3000	2951	2196	16°/16°	2.0
DOC240	134-1398	24 LED 48W / 700 mA	3000	5903	2196	16°/16°	2.0

[EE]	Part ID	Light source	K	lm*	cd/klm	C ₀ C ₁₈₀	kg
DOC110	134-1631	6 LED 12W / 700 mA	3000	1476	7207	7°/7°	1.3
DOC220	134-1335	12 LED 24W / 700 mA	3000	2951	7191	7°/7°	2.0
DOC240	134-1400	24 LED 48W / 700 mA	3000	5903	7207	7°/7°	2.0

[EES]	Part ID	Light source	K	lm*	cd/klm	C ₀ C ₁₈₀	kg
DOC110	134-1633	6 LED 12W / 700 mA	3000	1476	22108	5°/5°	1.3
DOC220	134-1211	12 LED 24W / 700 mA	3000	2951	20398	5°/5°	2.0
DOC240	134-1402	24 LED 48W / 700 mA	3000	5903	22108	5°/5°	2.0

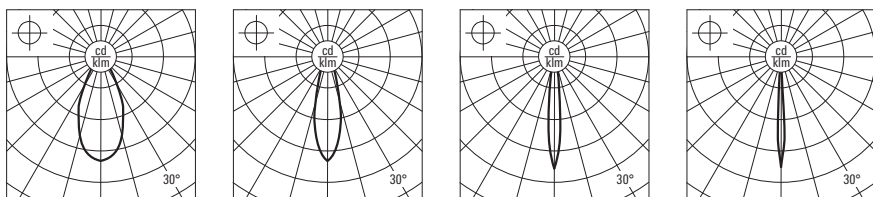
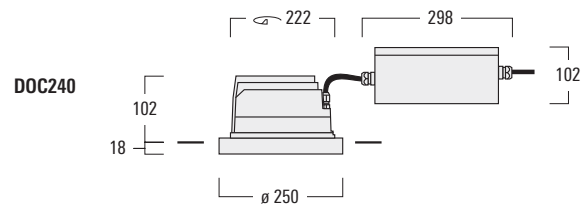
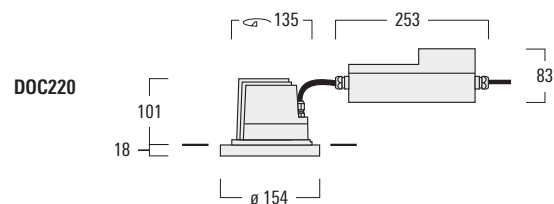
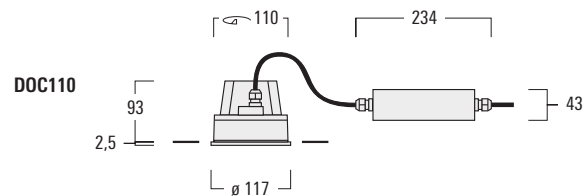

[B] [M] [EE] [EES]

* Nominal lumen output based on LED manufacturers data at 85°C T_J. For rated lumens at 25°C T_q and latest data refer to www.we-ef.com.

DOC200 SERIES

Downlight, wide beam distribution, 'darklight', symmetric.

IP66, Class I. IK07. Marine-grade, die-cast aluminium alloy. 5CE superior corrosion protection including PCS hardware. Powdercoat finish in RAL 9004, RAL 9006, RAL 9007 or RAL 9016. Silicone rubber gasket. Safety glass lens, hinged. Frame with safety catch. Two cable entries. Anodised aluminium reflector with PMMA LED diffuser.

EC electronic converter in thermally separated compartment.

A pre-installation blockout, proud or flush, is available and recommended for mounting in concrete ceilings. To be ordered separately.

Light source

LED 24 W, 3000 K,
for 4000 K refer to www.we-ef.com



Light distribution

[BD]

Accessories

■ Mounting, page 132

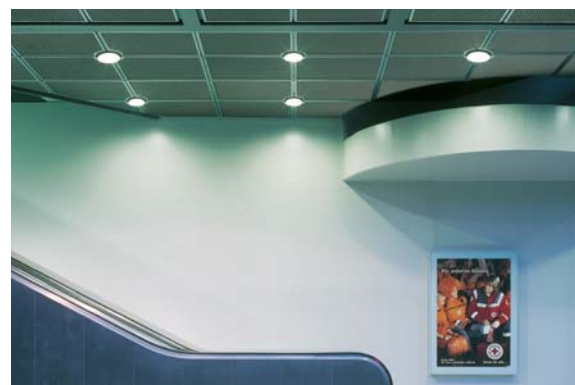

Train station Berlin Südkreuz, Berlin (D). Architect: J.S.K. GmbH, Berlin. Lighting design: DE Consult, Berlin.



[BD] Wide beam distribution, symmetric – Darklight



[BD]	Part ID	Light source	K	lm*	cd/klm	C ₀ C ₁₈₀	kg
DOC220	134-1483	LED-FT 24W	3000	3795	752	25°/25°	2.3

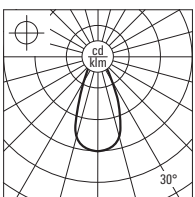
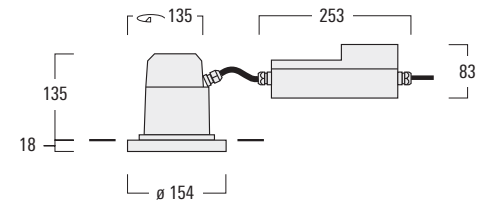

[BD]

* Nominal lumen output based on LED manufacturers data at 25°C T_c. For rated lumens at 25°C T_q and latest data refer to www.we-ef.com.

DOC200 SERIES

Downlight, medium or very narrow beam distribution, symmetric.

IP66, Class I. IK07. Marine-grade, die-cast aluminium alloy. 5CE superior corrosion protection including PCS hardware. Powdercoat finish in RAL 9004, RAL 9006, RAL 9007 or RAL 9016. Silicone rubber gasket. Safety glass lens, hinged. Frame with safety catch. Two cable entries. Anodised aluminium reflector.

HPF or ECG control gear in thermally separated compartment.

A pre-installation blockout, proud or flush, is available and recommended for mounting in concrete ceilings.

Light source
HIT 20-150 W

Light distributions
[M] [EE]

Accessories

■ Mounting, page 132

■ Optical, page 134



Metro station Breslauer Platz, Koeln (D). Architect: Architekturbüro Büder + Wenzel Architekten. Lighting design: Licht Kunst Licht.



[M] [EE]

[M] Medium beam distribution, symmetric
 [EE] Very narrow beam distribution, symmetric

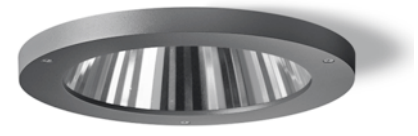

[M]	Part ID	Light source	lm	cd/klm	C ₀ C ₁₈₀	kg
DOC220	134-0802 [ECG]	HIT-TC-CE 20W G8.5	1700	2145	12°/12°	2.6
	134-0803 [ECG]	HIT-TC-CE 35W G8.5	3500	1441	18°/18°	2.6
DOC240	134-0815 [ECG]	HIT-CE 70W G12	7300	1643	20°/20°	5.8
	134-0816 [ECG+G9]*	HIT-CE 70W G12	7300	1643	20°/20°	5.8
	134-0819 [HPF]	HIT-CE 150W G12	15000	1280	23°/23°	7.5
	134-0820 [HPF+G9]*	HIT-CE 150W G12	15000	1280	23°/23°	7.5

[EE]	Part ID	Light source	lm	cd/klm	C ₀ C ₁₈₀	kg
DOC220	134-0805 [ECG]	HIT-TC-CE 20W G8.5	1700	10244	4°/4°	2.6
	134-0806 [ECG]	HIT-TC-CE 35W G8.5	3500	11214	4°/4°	2.6
DOC240	134-0825 [ECG]	HIT-CE 70W G12	7300	29929	3°/3°	5.8
	134-0826 [ECG+G9]*	HIT-CE 70W G12	7300	29929	3°/3°	5.8
	134-0829 [HPF]	HIT-CE 150W G12	15000	18752	4°/4°	7.5
	134-0830 [HPF+G9]*	HIT-CE 150W G12	15000	18752	4°/4°	7.5

* Version with HPF or ECG control gear and lampholder G9 for emergency light.

DOC220

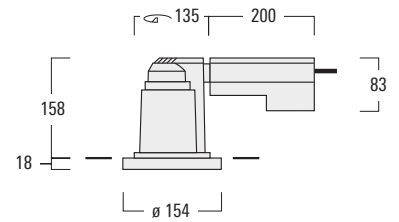

DOC240

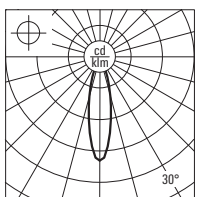
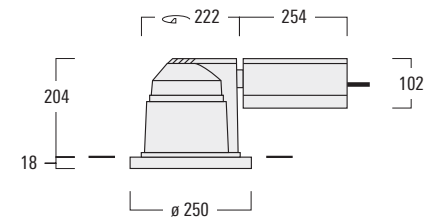

[M]

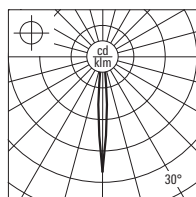

[EE]

DAC200 GIMBAL SERIES

Surface mounted downlight, wide, medium, very narrow or very narrow beam distribution 'sharp cut-off', symmetric, or wallwash distribution, asymmetric. Tilt and rotatable.

IP65, Class I. IK07. Marine-grade die-cast aluminium alloy. 5CE superior corrosion protection including PCS hardware. Powdercoat finish in RAL 9004, RAL 9006, RAL 9007 or RAL 9016. Silicone rubber gasket. Safety glass lens, hinged. Frame with safety catch. Two cable entries.

EC electronic converter in thermally separated compartment.

Factory installed LED circuit board. LED boards can be easily removed for upgrading.

PMMA LED lens array. 30° tilt and 355° rotatable.

Light source

LED 18 W, 3000 K,
for 4000 K refer to www.we-ef.com

Light distributions

[B] [M] [EE] [EES] [A20]

Accessories

■ Optical, page 134



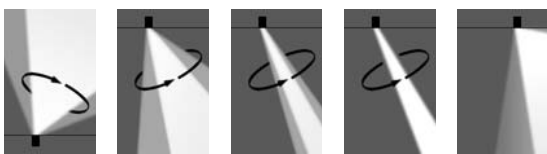

- [B] Wide beam distribution, symmetric
- [M] Medium beam distribution, symmetric,
- [EE] Very narrow beam distribution, symmetric
- [EES] Very narrow beam distribution, symmetric, 'sharp cut-off'
- [A20] Wallwash distribution, asymmetric



[B]	Part ID	Light source	K	lm*	cd/klm	C ₀ C ₁₈₀	kg	
DAC240-GB	134-1596	12 LED 18W / 500 mA	3000	2217	920	25°/25°	8.5	
[M]	Part ID	Light source	K	lm*	cd/klm	C ₀ C ₁₈₀	kg	
DAC240-GB	134-1598	12 LED 18W / 500 mA	3000	2217	2196	16°/16°	8.5	
[EE]	Part ID	Light source	K	lm*	cd/klm	C ₀ C ₁₈₀	kg	
DAC240-GB	134-1602	12 LED 18W / 500 mA	3000	2217	7191	7°/7°	8.5	
[EES]	Part ID	Light source	K	lm*	cd/klm	C ₀ C ₁₈₀	kg	
DAC240-GB	134-1605	12 LED 18W / 500 mA	3000	2217	20389	5°/5°	8.5	
[A20]	Part ID	Light source	K	lm*	cd/klm	C ₀ C ₁₈₀	C ₉₀ C ₂₇₀	kg
DAC240-GB	134-1600	12 LED 18W / 500 mA	3000	2217	787	15°/16°	35°/35°	8.5

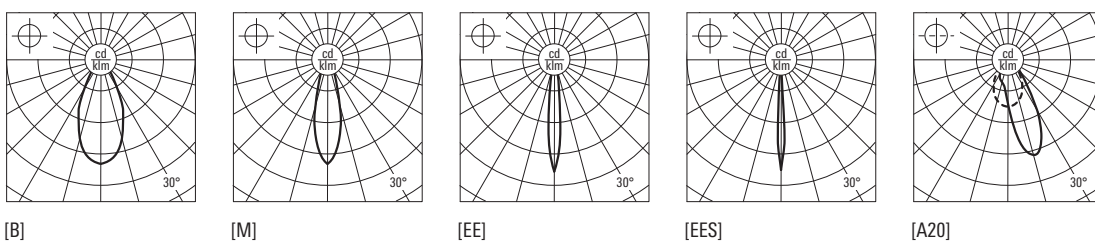
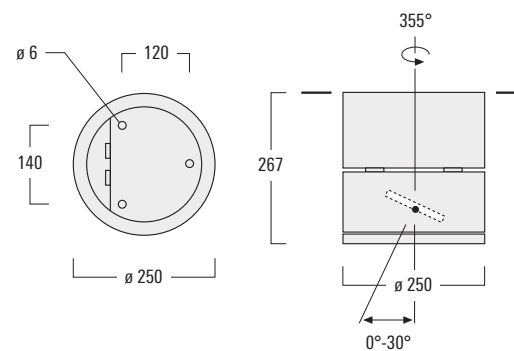

* Nominal lumen output based on LED manufacturers data at 85°C T_j. For rated lumens at 25°C T_a and latest data refer to www.we-ef.com.

DAC200 SERIES

Surface mounted downlight, wide, medium, very narrow or very narrow beam
'sharp cut-off' distribution, symmetric.

IP65, Class I. IK07. Marine-grade die-cast aluminium alloy. 5CE superior corrosion protection including PCS hardware. Powdercoat finish in RAL 9004, RAL 9006, RAL 9007 or RAL 9016. Silicone rubber gasket. Safety glass lens, hinged. Frame with safety catch. Two cable entries.

EC electronic converter in thermally separated compartment.

Factory installed LED circuit board. LED boards can be easily removed for upgrading.

PMMA LED lens array.

Light source

LED 24-48 W, 3000 K,
for 4000 K refer to www.we-ef.com

Light distributions

[B] [M] [EE] [EES]

Accessories

■ Optical, page 134



Steinmüller passage, Gummersbach (D)



[B] [M] [EE] [EES]

- [B] Wide beam distribution, symmetric
- [M] Medium beam distribution, symmetric
- [EE] Very narrow beam distribution, symmetric
- [EES] Very narrow beam distribution, symmetric, 'sharp cut-off'



[B]	Part ID	Light source	K	lm*	cd/klm	C ₀ C ₁₈₀	kg
DAC220	134-1424	12 LED 24W / 700 mA	3000	2951	920	25°/25°	2.9
DAC240	134-1432	24 LED 48W / 700 mA	3000	5903	934	25°/25°	7.6

[M]	Part ID	Light source	K	lm*	cd/klm	C ₀ C ₁₈₀	kg
DAC220	134-1425	12 LED 24W / 700 mA	3000	2951	2196	16°/16°	2.9
DAC240	134-1433	24 LED 48W / 700 mA	3000	5903	2196	16°/16°	7.6

[EE]	Part ID	Light source	K	lm*	cd/klm	C ₀ C ₁₈₀	kg
DAC220	134-1426	12 LED 24W / 700 mA	3000	2951	7191	7°/7°	2.9
DAC240	134-1434	24 LED 48W / 700 mA	3000	5903	7207	7°/7°	7.6

[EES]	Part ID	Light source	K	lm*	cd/klm	C ₀ C ₁₈₀	kg
DAC220	134-1427	12 LED 24W / 700 mA	3000	2951	20398	5°/5°	2.9
DAC240	134-1435	24 LED 48W / 700 mA	3000	5903	22108	5°/5°	7.6

DAC220

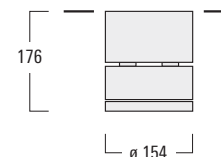
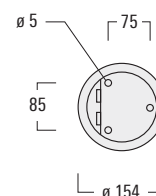

DAC240

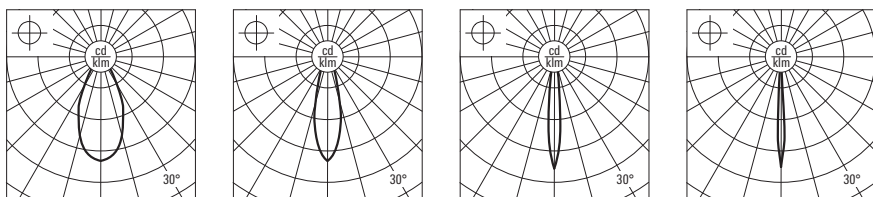
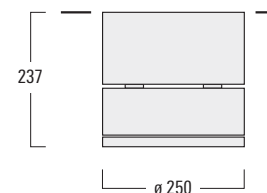
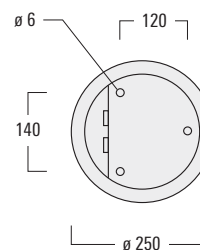

[B] [M] [EE] [EES]

* Nominal lumen output based on LED manufacturers data at 85°C T_J. For rated lumens at 25°C T_q and latest data refer to www.we-ef.com.

DAC200 SERIES

Surface mounted downlight, medium or very narrow beam distribution, symmetric.

IP65, Class I. IK07. Marine-grade, die-cast aluminium alloy. 5CE superior corrosion protection including PCS hardware. Powdercoat finish in RAL 9004, RAL 9006, RAL 9007 or RAL 9016. Silicone rubber gasket. Safety glass lens, hinged. Frame with safety catch. Two cable entries. Anodised aluminium reflector.

HPF or ECG control gear in thermally separated compartment.

Light source

QT 65 W

HIT 20-150 W

Light distributions

[M] [EE]

Accessories

■ Optical, page 134



Southern Cross Station. Melbourne (AUS). Architect: Nicholas Grimshaw & Partners. Lighting design: Vision Design Studio.



[M] [EE]

[M] Medium beam distribution, symmetric
 [EE] Very narrow beam distribution, symmetric



[M]	Part ID	Light source	lm	cd/klm	C ₀ C ₁₈₀	kg
DAC220	134-1456 [ET]	QT 12ax 65W/c GY6.35	1650	1481	10°/10°	3.2
	134-1457 [ECG]	HIT-TC-CE 20W G8.5	1700	2145	12°/12°	3.3
	134-1458 [ECG]	HIT-TC-CE 35W G8.5	3500	1441	18°/18°	3.3
DAC240	134-1470 [ECG]	HIT-CE 70W G12	7300	1643	20°/20°	8.8
	134-1471 [ECG+G9]*	HIT-CE 70W G12	7300	1643	20°/20°	8.9
	134-1472 [HPF]	HIT-CE 150W G12	15000	1280	23°/23°	10.0
	134-1473 [HPF+G9]*	HIT-CE 150W G12	15000	1280	23°/23°	10.1

[EE]	Part ID	Light source	lm	cd/klm	C ₀ C ₁₈₀	kg
DAC220	134-1459 [ET]	QT 12ax 65W/c GY6.35	1650	20740	3°/3°	3.2
	134-1460 [ECG]	HIT-TC-CE 20W G8.5	1700	10244	4°/4°	3.3
	134-1461 [ECG]	HIT-TC-CE 35W G8.5	3500	11214	4°/4°	3.3
DAC240	134-1476 [ECG]	HIT-CE 70W G12	7300	29929	3°/3°	8.8
	134-1477 [ECG+G9]*	HIT-CE 70W G12	7300	29929	3°/3°	8.9
	134-1478 [HPF]	HIT-CE 150W G12	15000	18752	4°/4°	10.0
	134-1479 [HPF+G9]*	HIT-CE 150W G12	15000	18752	4°/4°	10.1

* Version with HPF or ECG control gear and lampholder G9 for emergency light.

DAC220

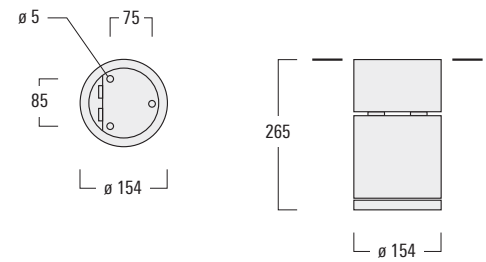

DAC240

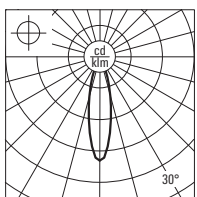
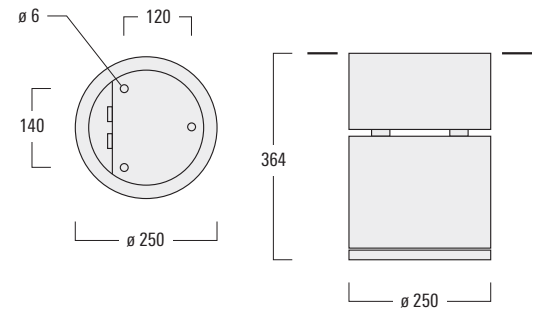

[M]

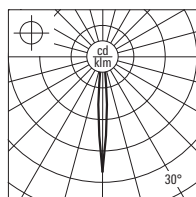

[EE]

MOUNTING ACCESSORIES

Installation blockout — Luminaire frame proud of surface			A	B	C
BD011-I	134-1639	for DOC110	333	232	172
BD022-I	134-0797	for DOC220	383	200	209
BD024-I	134-0798	for DOC240 / DOC240-GB	570	305	285

Installation blockout — Luminaire frame flush with surface			A	B	C
BD022-II	134-1161	for DOC220	383	200	227
BD024-II	134-1162	for DOC240 / DOC240-GB	573	305	303

Installation blockout — Luminaire frame flush with surface, with shadow line			A	B	C
BD011-III	134-1641	for DOC110	333	232	172
BD022-III	134-1497	for DOC220	383	200	227
BD024-III	134-1498	for DOC240 / DOC240-GB	573	305	303

Installation blockouts to suit project specific requirements are available on request.

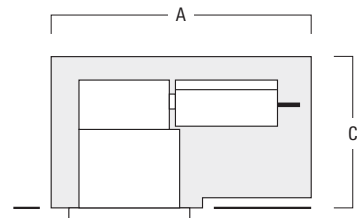

Type I
Luminaire frame proud of surface

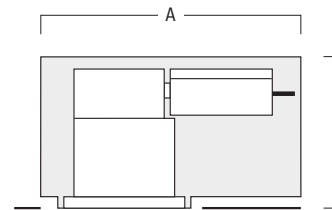
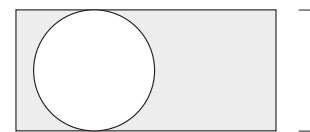

Type II
Luminaire frame flush with surface

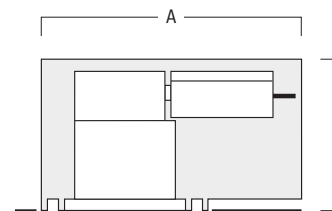
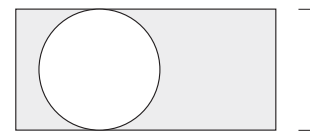

Type III
Luminaire frame flush with surface,
with shadow line

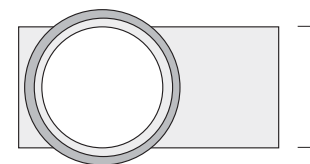



Metro station Heumarkt, Köln (D). Planning: Lichtdesign Ingenieurgesellschaft Prof. Dr. Ing Heinrich Kramer, Köln.

OPTICAL ACCESSORIES

Gimbal and Fixed

A maximum of one internal optical accessory.

Flood lens IO-360**

for DOC220* / DAC220	134-1440
for DOC240 / DAC240	134-1441
for DOC240-GB / DAC240-GB	134-1442

Linear spread lens IO-180**

for DOC220* / DAC220	134-1381
for DOC240 / DAC240	134-1382
for DOC240-GB / DAC240-GB	185-2632

Wallwash lens IO-20

for DOC220* / DAC220 [M]	134-1491
for DOC240 / DAC240 [M]	134-1492

Honeycomb louvre IW**

for DOC220* / DAC220	134-1444
for DOC240 / DAC240	134-1445
for DOC240-GB / DAC240-GB	134-1449

* does not fit in combination with [BD] version

** does not fit in combination with [B] lens

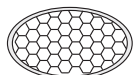

IW

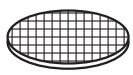

IO-360



IO-180

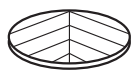

IO-20

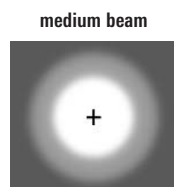

with IO-360

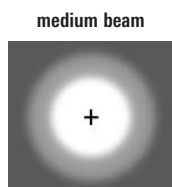

with IO-180

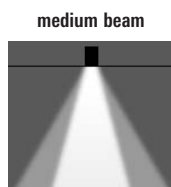
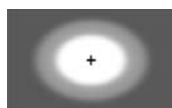

with IO-20



OPTICAL ACCESSORIES

Gimbal and Fixed

A maximum of two internal optical accessories for Gimbal and one for Fixed.

Flood lens IO-360

for DOC220 / DAC220	134-1167
for DOC240 / DAC240	134-1174
for DOC240-GB	134-1181

Linear spread lens IO-180

for DOC220 / DAC220	134-1168
for DOC240 / DAC240	134-1175
for DOC240-GB	134-1182

Dichroic Colour Filter IF	red	green	blue	yellow
for DOC220 / DAC220	134-1163	134-1164	134-1165	134-1166
for DOC240 / DAC240	134-1170	134-1171	134-1172	134-1173
for DOC240-GB	134-1177	134-1178	134-1179	134-1180

Concentric louvre IQ

for DOC220 / DAC220 [EE]	134-1169
for DOC240 / DAC240 [EE]	134-1176
for DOC240-GB [EE]	134-1183



IQ



IF





Metro station Heumarkt, Köln (D). Planning: Lichtdesign Ingenieurgesellschaft Prof. Dr. Ing Heinrich Kramer, Köln.

IOS® Beam distributions for bollards and pathway luminaires

[C60] controlled, symmetric

[A60] forward throw distribution, asymmetric

[] diffused

Bollards and pathway luminaires



XRX / XRY300 LED 140

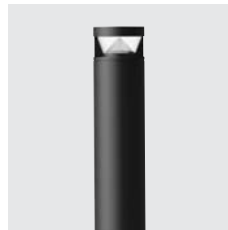

KTY200 LED 142



ZFY200 LED 144



CFY200 LED 146



NTY100 LED 148



NTY100 150



ACCESSORIES
■ Mounting 152

XRX300 / XRY300 SERIES

Bollards and pathway luminaires, diffused distribution, symmetric.

IP55, Class I. IK10. Marine-grade, all aluminium construction. 5CE superior corrosion protection including PCS hardware. Powdercoat finish in RAL 9004, RAL 9006, RAL 9007 or RAL 9016. Silicone rubber gaskets. Polycarbonate (XRX324 / XRY324) or borosilicate glass lens (XRX334 / XRY334).

Integral EC electronic converter.

Factory installed LED circuit board. LED boards can be easily removed for upgrading.

XRY324 / XRY334: Pre-wired post complete with cable connecting box and service door for mains connection.

Light source

LED 8-12 W, 3000 K,
for 4000 K refer to www.we-ef.com

Accessories

■ Mounting, page 152



Siam Paragon Shopping Center. Bangkok (TH). Architect: Wimberly Allison Tong and Goo/RTKL International. Lighting design: LPA.



XR334

	Part ID	Light source	K	lm*	Factor**	kg	
	XR324	115-9687	LED 8W / 350 mA	3000	1320	1.00	3.4
	XR334	115-9624	LED 12W / 500 mA	3000	1860	1.00	8.3
	XRY324	115-9214	LED 8W / 350 mA	3000	1320	1.00	7.5
	XRY334	115-9612	LED 12W / 500 mA	3000	1860	1.00	16.8

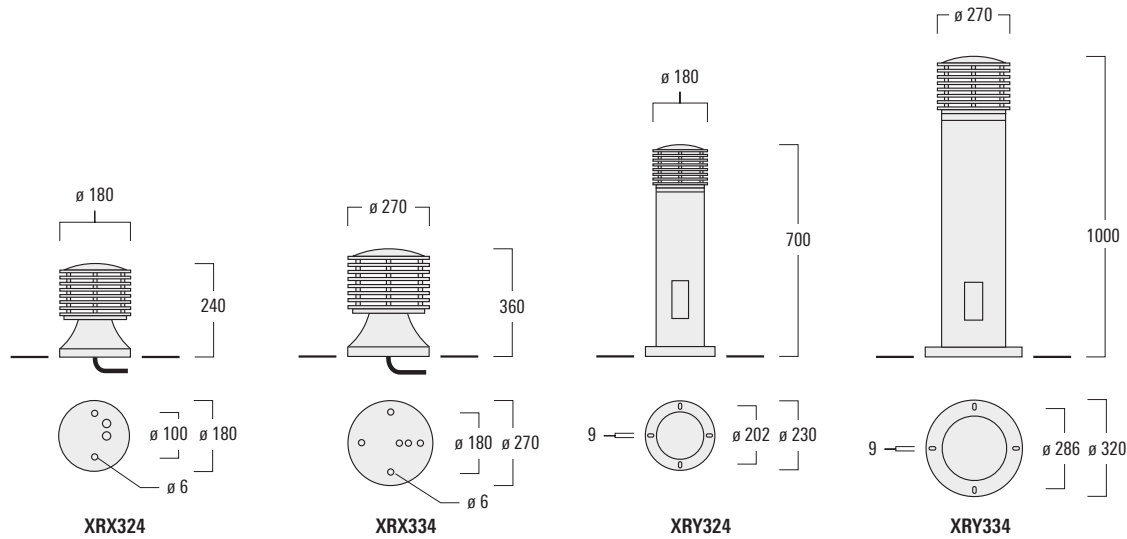

XR324

XR334

XRY324

XRY334

XRY334

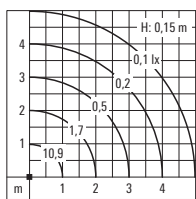

XR324

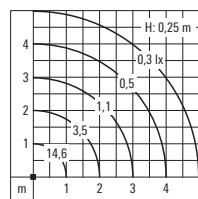

XR334

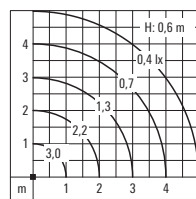

XRY324

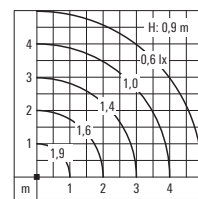

XRY334

* Nominal lumen output based on LED manufacturers data at 85°C T_J. For rated lumens at 25°C T_q and latest data refer to www.we-ef.com.
 ** Multiplier for Isolux value

KTY200 SERIES

Bollard, controlled distribution, symmetric.

IP66, Class I. IK10. Marine-grade, all aluminium construction. 5CE superior corrosion protection including PCS hardware. Powdercoat finish in RAL 9004, RAL 9006, RAL 9007 or RAL 9016. Silicone rubber gaskets. Polycarbonate lens.

Integral EC electronic converter.

Factory installed LED circuit board. LED boards can be easily removed for upgrading.

Pre-wired post complete with cable connecting box for mains connection.

Light source

LED 18-26 W, 3000 K,
for 4000 K refer to www.we-ef.com

Light distribution

[C60]

Accessories

■ Mounting, page 152





[C60] Controlled distribution, symmetric

[C60]	Height	Part ID	Light source	K	lm*	Factor**	kg
KTY234	600	114-9179	6 LED 18W / 1050 mA	3000	2340	1.00	12.8
	600	114-9181	6 LED 26W / 1400 mA	3000	2993	1.28	12.8
KTY234	1000	114-9091	6 LED 18W / 1050 mA	3000	2340	1.00	14.7
	1000	114-9093	6 LED 26W / 1400 mA	3000	2993	1.28	14.7

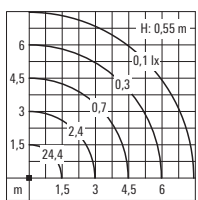
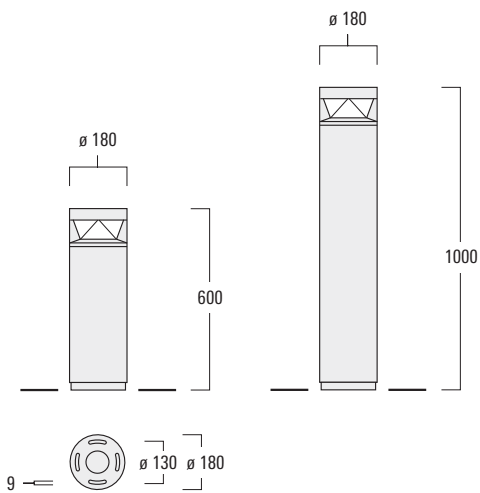

[C60] – H = 600 mm

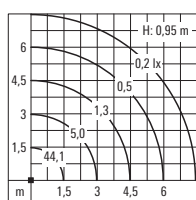

[C60] – H = 1000 mm

KTY234



* Nominal lumen output based on LED manufacturers data at 85°C T_c. For rated lumens at 25°C T_q and latest data refer to www.we-ef.com.
 ** Multiplier for Isolux value

ZFY200 SERIES

Bollard, controlled distribution, symmetric.

IP66, Class I, IK10. Marine-grade, all aluminium construction. 5CE superior corrosion protection including PCS hardware. Powdercoat finish in RAL 9004, RAL 9006, RAL 9007 or RAL 9016. Silicone rubber gaskets. Polycarbonate lens.

Integral EC electronic converter.

Factory installed LED circuit board. LED board can be easily removed for upgrading. PMMA double lens.

Pre-wired post complete with cable connecting box for mains connection.

Light source

LED 17-24 W, 3000 K,
for 4000 K refer to www.we-ef.com

Light distribution

[C60]

Accessories

■ Mounting, page 152





[C60] Controlled distribution, symmetric

[C60]	Height	Part ID	Light source	K	lm*	Factor**	kg
ZFY230	600	117-0201	LED-FT 17W	3000	2800	1.00	12.8
ZFY230	1000	117-0199	LED-FT 17W	3000	2800	1.00	14.7
ZFY250	600	117-0207	LED-FT 17W	3000	2800	1.00	19.4
ZFY250	600	117-0209	LED-FT 24W	3000	3795	1.36	19.4
ZFY250	1000	117-0203	LED-FT 17W	3000	2800	1.00	21.5
ZFY250	1000	117-0205	LED-FT 24W	3000	3795	1.36	21.5

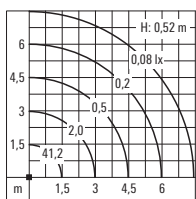
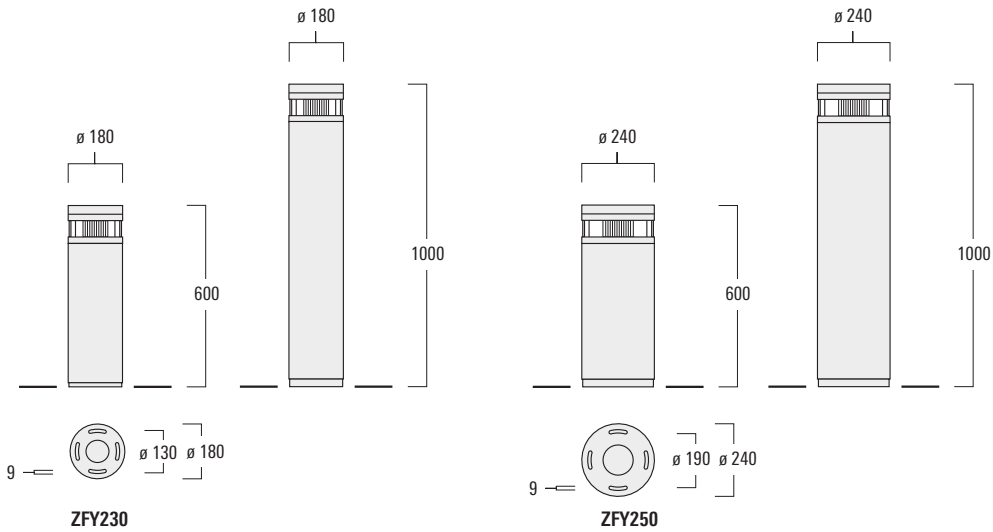

[C60] – H = 600 mm

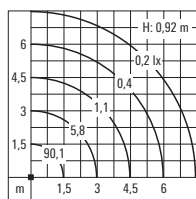

[C60] – H = 1000 mm

ZFY230



* Nominal lumen output based on LED manufacturers data at 25°C T_J. For rated lumens at 25°C T_q and latest data refer to www.we-ef.com.
 ** Multiplier for Isolux value

CFY200 SERIES

Bollard, forward throw distribution, asymmetric, single or double sided.

IP66, Class I. IK10. Marine-grade, all aluminium construction. 5CE superior corrosion protection including PCS hardware. Powdercoat finish in RAL 9004, RAL 9006, RAL 9007 or RAL 9016. Silicone rubber gaskets. Satinised glass main lens.

Integral EC electronic converter.

Factory installed LED circuit board. LED boards can be easily removed for upgrading.

Pre-wired post complete with cable connecting box for mains connection.

Light source

LED 12-36 W, 3000 K,
for 4000 K refer to www.we-ef.com

Accessories

■ Mounting, page 152



single side	Height	Part ID	Light source	K	lm*	Factor**	kg
CFY259	600	117-0211	6 LED 12W	3000	1120	1,00	15.0
CFY259	600	117-0213	6 LED 18W	3000	1629	1,00	15.0
CFY259	1000	117-0217	6 LED 12W	3000	1629	1,00	18.0
CFY259	1000	117-0215	6 LED 18W	3000	2340	1,00	18.0

double side	Height	Part ID	Light source	K	lm*	Factor**	kg
CFY259	600	117-0273	2x 6 LED 24W	3000	2x 1629	1,00	15.0
CFY259	600	117-0275	2x 6 LED 36W	3000	2x 2340	1,00	15.0
CFY259	1000	117-0267	2x 6 LED 24W	3000	2x 1629	1,00	18.0
CFY259	1000	117-0269	2x 6 LED 36W	3000	2x 2340	1,00	18.0

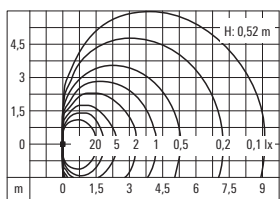
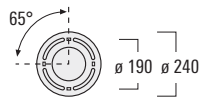
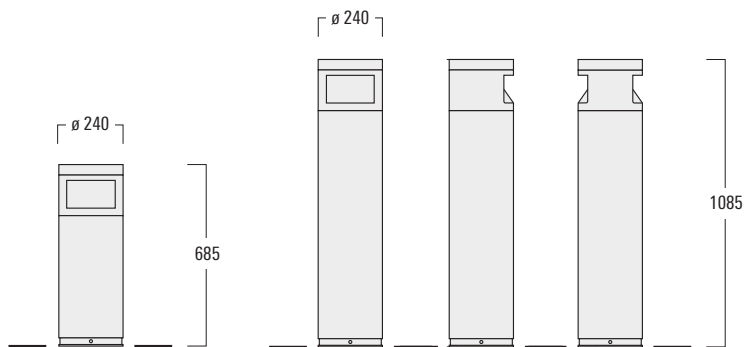

H = 600 mm

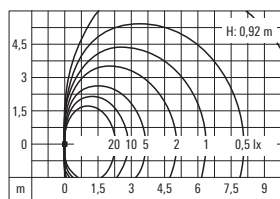

H = 1000 mm



* Nominal lumen output based on LED manufacturers data at 85°C T_J. For rated lumens at 25°C T_q and latest data refer to www.we-ef.com.

** Multiplier for Isolux value

NTY100 SERIES

Bollard, forward throw distribution, asymmetric, single or double sided.

IP65, Class I, IK10. Marine-grade, all aluminium construction. 5CE superior corrosion protection including PCS hardware. Powdercoat finish in RAL 9004, RAL 9006, RAL 9007 or RAL 9016. Silicone rubber gaskets. Prismatic polycarbonate lens. Single or double sided distribution.

Integral EC electronic converter.

Factory installed LED circuit board. LED boards can be easily removed for upgrading.

Pre-wired post complete with cable connecting box and service door for mains connection.

Light source

LED 12-36 W, 3000 K,
for 4000 K refer to www.we-ef.com

Light distribution

[A60]

Accessories

■ Mounting, page 152



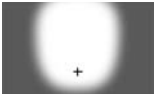

[A60] Forward throw distribution, asymmetric

[A60] single sided	Part ID	Light source	K	lm*	Factor**	kg
NTY184	112-0303	6 LED 12W / 700 mA	3000	1476	1.00	17.0
	112-0299	6 LED 18W / 1050 mA	3000	2340	1.59	17.0

[A60] double sided	Part ID	Light source	K	lm*	Factor**	kg
NTY184	112-0305	2 x 6 LED 24W / 700 mA	3000	2 x 1476	1.00	17.0
	112-0301	2 x 6 LED 36W / 1050 mA	3000	2 x 2340	1.59	17.0

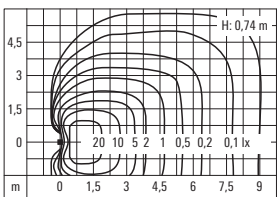
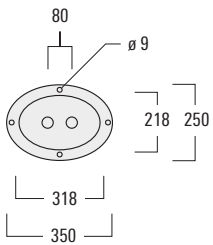
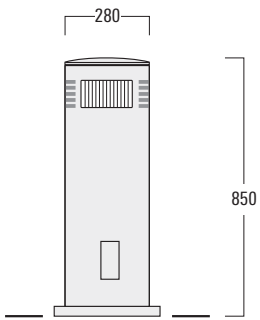

[A60] single sided

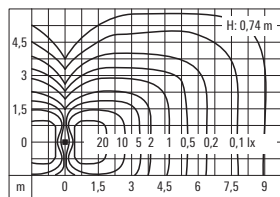

[A60] double sided



* Nominal lumen output based on LED manufacturers data at 85°C T_J. For rated lumens at 25°C T_q and latest data refer to www.we-ef.com.

** Multiplier for Isolux value

NTY100 SERIES

Bollard, controlled single or double sided distribution.

IP65, Class I. IK10. Marine-grade, all aluminium construction. 5CE superior corrosion protection including PCS hardware. Powdercoat finish in RAL 9004, RAL 9006, RAL 9007 or RAL 9016. Silicone rubber gaskets. Prismatic polycarbonate lens. Anodised aluminium reflector. Single or double sided distribution.

Integral ECG control gear.

Pre-wired post complete with cable connecting box and service door for mains connection.

Light source
HIT 35-70 W

Accessories
■ Mounting, page 152



Fort Montluc. Lyon (F). Lighting design: Cobalt.

single sided	Part ID	Light source	lm	Factor*	kg
NTY184	112-0020 [ECG]	HIT-CE 35W G12	3600	1.00	17.5
	112-0021 [ECG]	HIT-CE 70W G12	7300	2.03	17.5

double sided	Part ID	Light source	lm	Factor*	kg
NTY184	112-0034 [ECG]	HIT-CE 35W G12	3600	1.00	17.5
	112-0035 [ECG]	HIT-CE 70W G12	7300	2.03	17.5

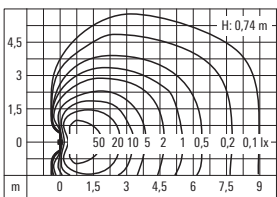
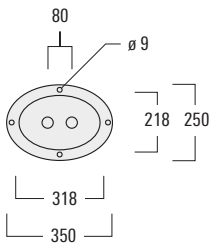
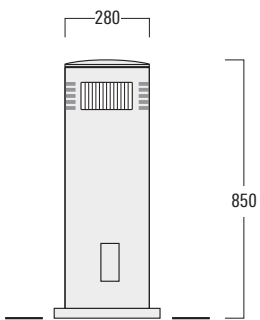

single sided

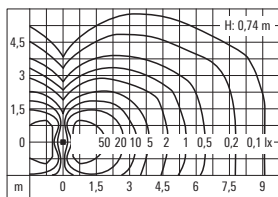

double sided



* Multiplier for Isolux value

MOUNTING ACCESSORIES

Planted roots

Galvanised steel, for bollards.			D	D1	kg
for CFY259 / ZFY250	300-1167	ESV4	240	190	6.0
KTY234 / ZFY230	300-0461	ESV4	145	130	4.4
XRY324	300-0464	ESV4	220	200	6.0
for XRY334	300-0586	ESV4	305	285	7.2
for NTY184	112-0022	ESV4			8.3

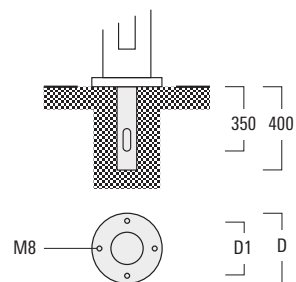

Planted root ESV4
300-1167
300-0461
300-0464
300-0586

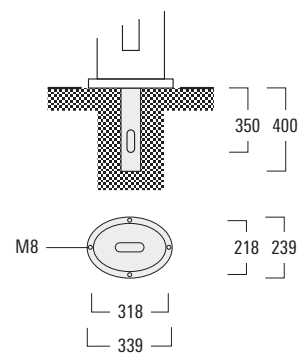

Planted root ESV4
112-0022



IOS® Beam distributions for light columns

[C60] controlled, symmetric
[] diffused

Light columns

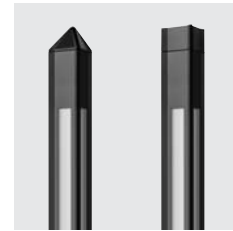

LSP / LTP400 LED 156



LSP / LTP400 158



LTM400 LED 160



LTM / LSM400 162



LTC400 164



LCI400 166



LGI400 168



ACCESSORIES
■ Mounting 170

LSP400 / LTP400 SERIES

Trilight column, three sided light output, diffused distribution, symmetric.

IP44, Class I, IK10. Marine-grade, all aluminium construction. 5CE superior corrosion protection including PCS hardware. Powdercoat finish in RAL 9004, RAL 9006, RAL 9007 or RAL 9016. Silicone rubber gaskets. Prismatic polycarbonate lenses, 3 x 120° offset. Anodised aluminium reflector.

Integral EC electronic converter.

Factory installed LED circuit board. LED boards can be easily removed for upgrading.

Service door with fused cable connecting box.

Light source

LED 37 W, 3000 K,
for 4000 K refer to www.we-ef.com



Accessories

■ Mounting, page 170



Eli and Edythe Broad Art Museum. Michigan State University. East Lansing, Michigan (USA). Architect: Zaha Hadid Architects. Lighting design: ARUP & Peter Basso Associates.



LSP434 / LSP444



LTP444

	Part ID	Light source	K	lm*	Factor**	kg
LSP434	116-0212	LED-FT 37 W	3000	5720	1.00	16.9
LSP444	116-0208	LED-FT 37 W	3000	5720	1.00	32.6

	Part ID	Light source	K	lm*	Factor**	kg
LTP434	116-0210	LED-FT 37 W	3000	5720	1.00	16.9
LTP444	116-0207	LED-FT 37 W	3000	5720	1.00	32.6

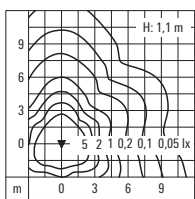

LTP434

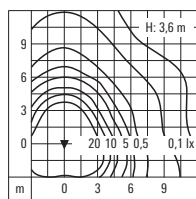

LTP444

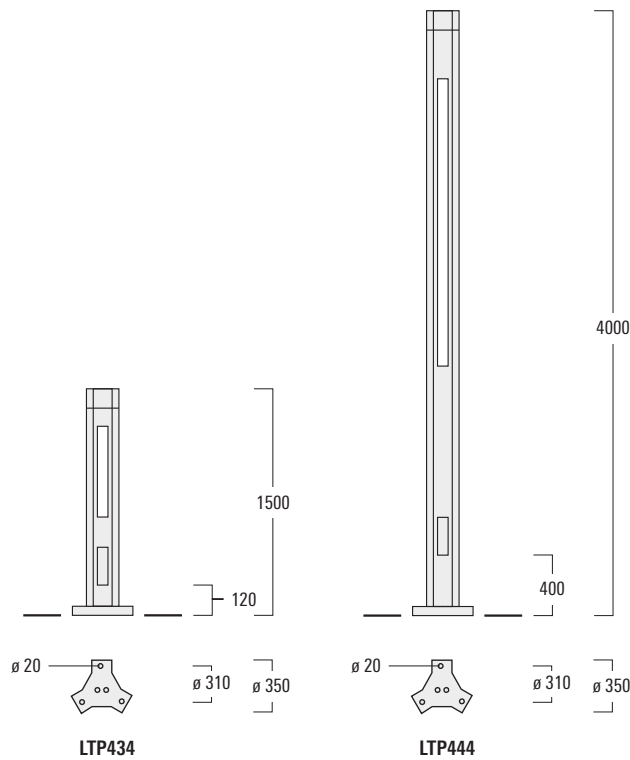

LTP434

LTP444

* Nominal lumen output based on LED manufacturers data at 25°C T_c. For rated lumens at 25°C T_q and latest data refer to www.we-ef.com.
 ** Multiplier for Isolux value

LSP400 / LTP400 SERIES

Trilight column, three sided light output, diffused distribution, symmetric.

IP44, Class I, IK10. Marine-grade, all aluminium construction. 5CE superior corrosion protection including PCS hardware. Powdercoat finish in RAL 9004, RAL 9006, RAL 9007 or RAL 9016. Silicone rubber gaskets. Prismatic polycarbonate lenses, 3 x 120° offset.

Anodised aluminium reflector.

Integral HPF control gear.

Service door with fused cable connecting box.

Light source
HIT 35-150 W

Accessories
■ Mounting, page 170



South Eastern Busway. Cultural Centre Station. Brisbane (AUS)



LSP434 / LSP444



LTP444

Part ID	Light source	lm	Factor*	kg
LSP434	116-0013 [HPF] HIT-CE 35W G12	3600	1.00	16.7
LSP444	116-0050 [HPF] HIT-CE 70W G12	7300	1.00	32.5
	116-0188 [HPF] HIT-CE 100W G12	9500	1.30	32.6
	116-0040 [HPF] HIT-CE 150W G12	15000	2.05	32.8

Part ID	Light source	lm	Factor*	kg
LTP434	116-0087 [HPF] HIT-CE 35W G12	3600	1.00	17.8
LTP444	116-0093 [HPF] HIT-CE 70W G12	7300	1.00	33.6
	116-0187 [HPF] HIT-CE 100W G12	9500	1.30	33.7
	116-0091 [HPF] HIT-CE 150W G12	15000	2.05	33.9

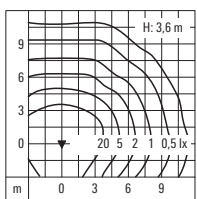

LSP444

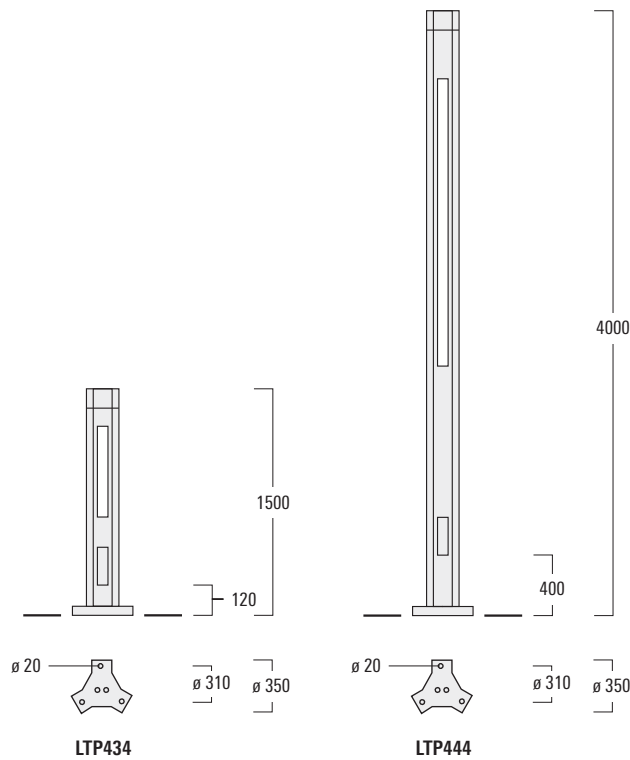

LTP434

LTP444

* Multiplier for Isolux value

LTM400 SERIES

Lightspike, controlled distribution, symmetric.

IP55, Class I. IK10. Marine-grade, all aluminium construction. 5CE superior corrosion protection including PCS hardware. Powdercoat finish in RAL 9004, RAL 9006, RAL 9007 or RAL 9016. Silicone rubber gaskets. Polycarbonate main lens.

Integral EC electronic converter.

Factory installed LED circuit board. LED boards can be easily removed for upgrading. PMMA double lens.

Service door with fused cable connecting box.

Light source

LED 17-24 W, 3000 K,
for 4000 K refer to www.we-ef.com

Light distribution

[C60]

Accessories

■ Mounting, page 170

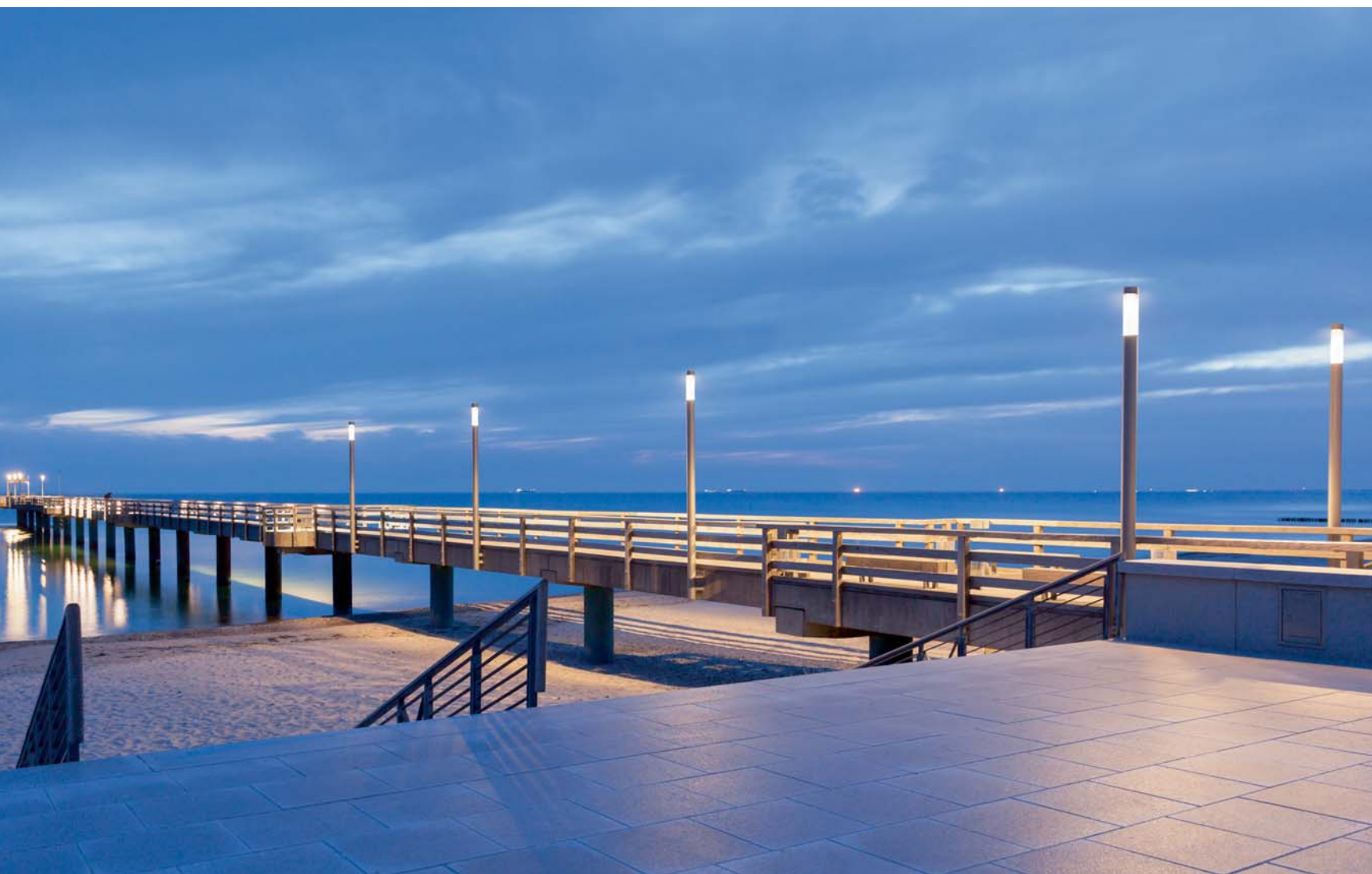

Pier seaside Heiligendamm (D). Lighting design: Institut für Gebäude + Energie + Licht Planung, Prof. Dr.-Ing. Thomas Römhild, Wismar.



[C60] Controlled distribution, symmetric

[C60]	Part ID	Light source	K	lm*	Factor**	kg
LTM440	115-1227	LED-FT 17W	3000	2800	1.00	25.0
	115-1229	LED-FT 24W	3000	3795	1.36	25.0

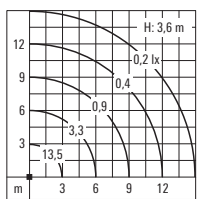

[C60]

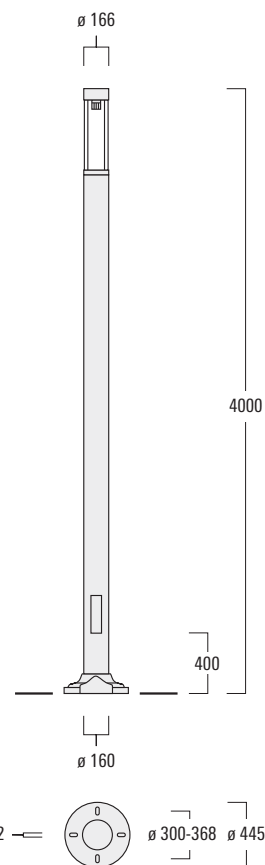

* Nominal lumen output based on LED manufacturers data at 25°C T_c. For rated lumens at 25°C T_q and latest data refer to www.we-ef.com.

** Multiplier for Isolux value

LSM400 / LTM400 SERIES

Lightspike, shielded light source, symmetric.

IP55, Class I, IK10. Marine-grade, all aluminium construction. 5CE superior corrosion protection including PCS hardware. Powdercoat finish in RAL 9004, RAL 9006, RAL 9007 or RAL 9016. Silicone rubber gaskets. Polycarbonate lens. Anodised aluminium reflector.

Integral HPF and ECG control gear.

Service door with fused cable connecting box.

Light source
HIE 70-100 W

Accessories
■ Mounting, page 170



Dovenshire Square. London (UK). Lighting design: Speirs & Majors Associates.

LSM440



LTM440



	Part ID	Light source	lm	Factor*	kg
LSM440	115-1141 [ECG]	HIE-CE 70W E27	6700	1.00	21.1
	115-1129 [HPF]	HIE-CE 100W E27	8500	1.27	22.5
LTM440	115-1144 [ECG]	HIE-CE 70W E27	6700	1.00	20.9
	115-1133 [HPF]	HIE-CE 100W E27	8500	1.27	22.3

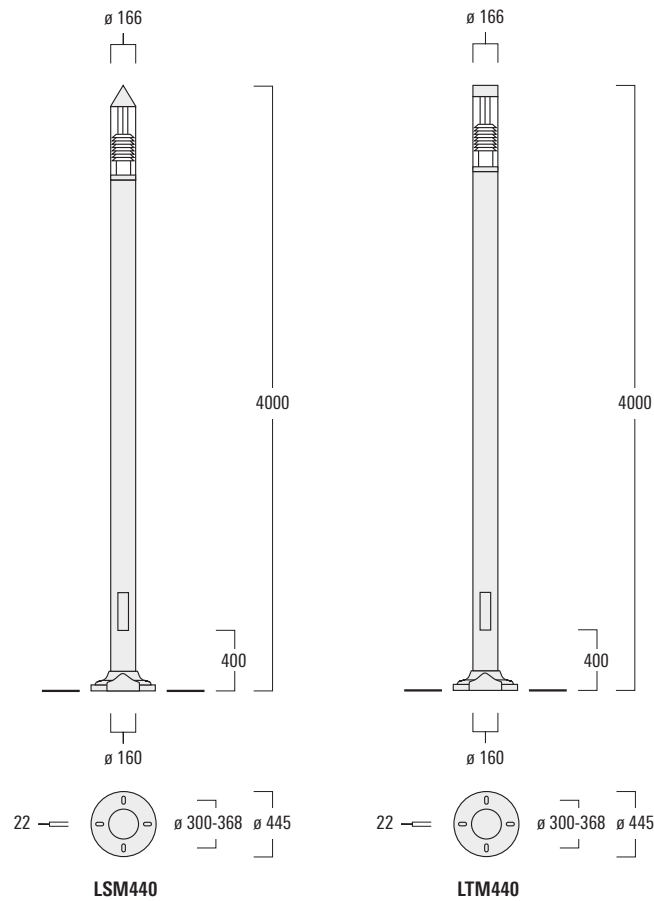

LSM440

LTM440

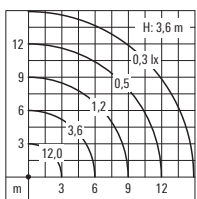

* Multiplier for Isolux value

LTC400 SERIES

Light column, shielded light source, symmetric.

IP55, Class I, IK10. Marine-grade, all aluminium construction. 5CE superior corrosion protection including PCS hardware. Powdercoat finish in RAL 9004, RAL 9006, RAL 9007 or RAL 9016. Silicone rubber gaskets. Polycarbonate lens.

Reflector and indirect reflector made from anodised aluminium for light control and shielding.

Integral HPF and ECG control gear.

Service door with fused cable connecting box.

Light source
HIE 70-100 W

Accessories
■ Mounting, page 170



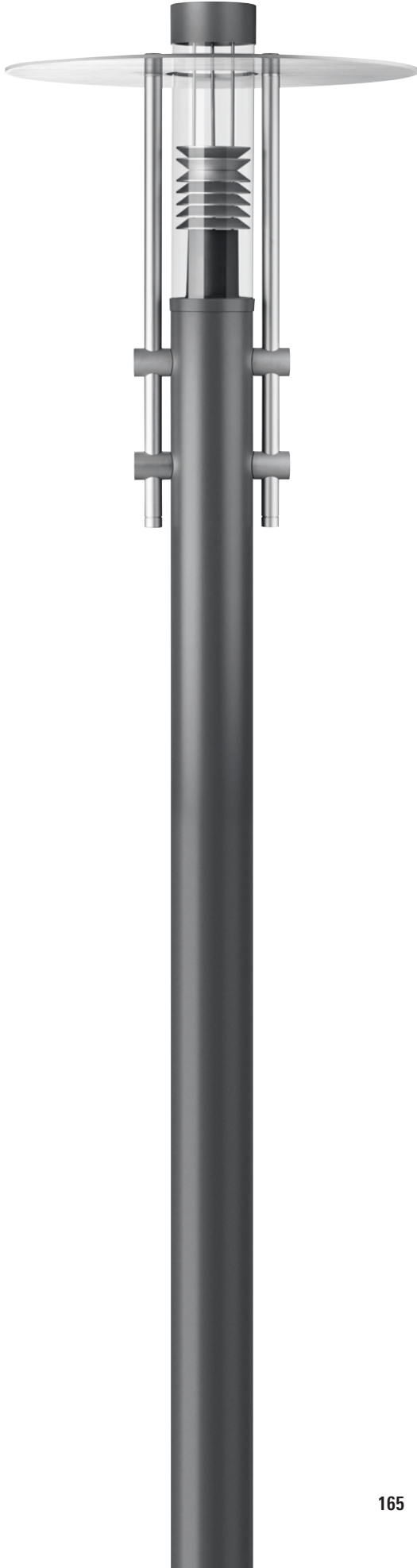

Part ID	Light source	lm	Factor*	kg
LTC440	115-1146 [ECG] HIE-CE 70W E27	6700	1.00	25.7
	115-1110 [HPF] HIE-CE 100W E27	8500	1.27	27.1

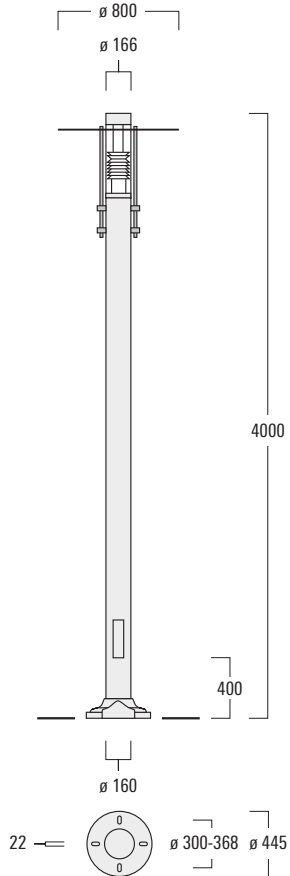
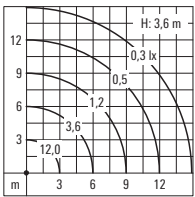

* Multiplier for Isolux value

LCI400 SERIES

Light column, indirect distribution, adjustable reflector system.

IP66, Class I. IK08. Marine-grade, all aluminium construction. 5CE superior corrosion protection including PCS hardware. Powdercoat finish in RAL 9004, RAL 9006, RAL 9007 or RAL 9016. Silicone rubber gaskets. Safety glass lens.

Reflector and indirect reflector made from anodised aluminium for light control and shielding. Adjustable from 10°-30°.

ECG control gear, thermally separated.

Service door with fused cable connecting box.

Light source
HIT 70-150 W

Accessories
■ Mounting, page 170



Duderstadt (D)

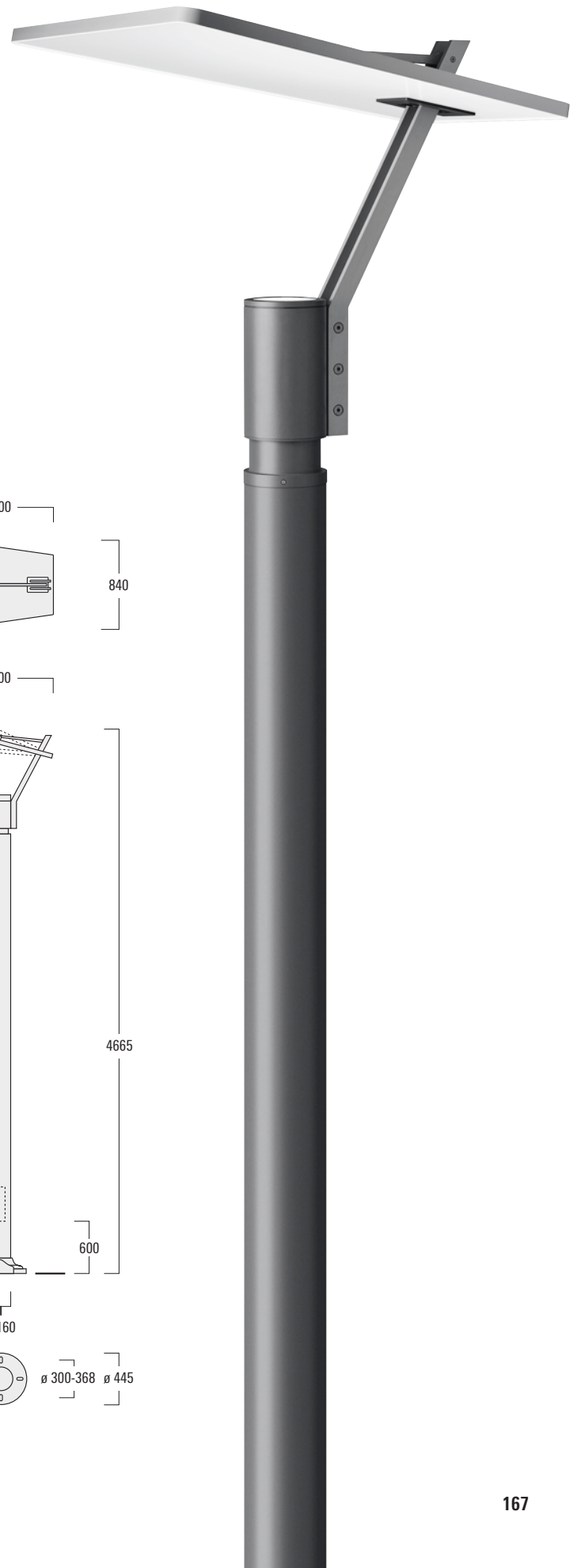

Part ID	Light source	lm	Factor*	kg
LCI440	118-0045 [ECG] HIT-CE 70W G12	7300	1.00	36.0
	118-0082 [ECG] HIT-CE 100W G12	9500	1.30	37.1
	118-0048 [ECG] HIT-CE 150W G12	15000	2.05	37.2

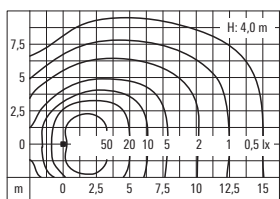
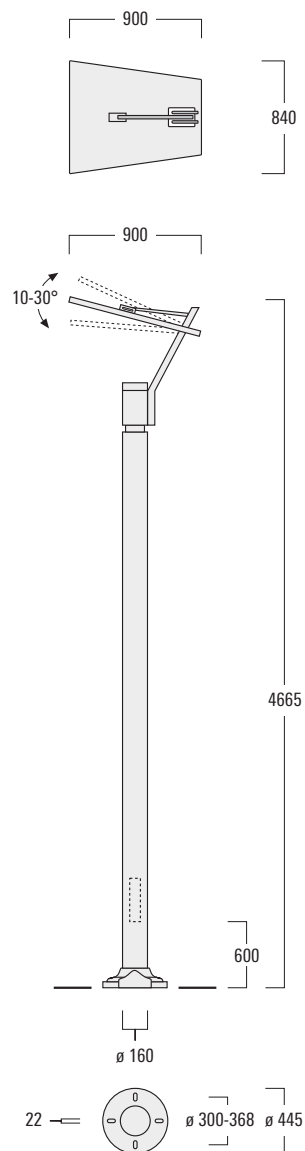

* Multiplier for Isolux value

LGI400 SERIES

Light column, indirect distribution, adjustable reflector system.

IP66, Class I, IK10. Marine-grade, all aluminium construction. 5CE superior corrosion protection including PCS hardware. Powdercoat finish in RAL 9004, RAL 9006, RAL 9007 or RAL 9016. Silicone rubber gaskets. Safety glass lens.

Reflector and indirect reflector made from anodised aluminium for light control and shielding. Adjustable from $\pm 7.5^\circ$.

ECG control gear, thermally separated.

Service door with fused cable connecting box.

Light source
HIT 70-150 W

Accessories
■ Mounting, page 170

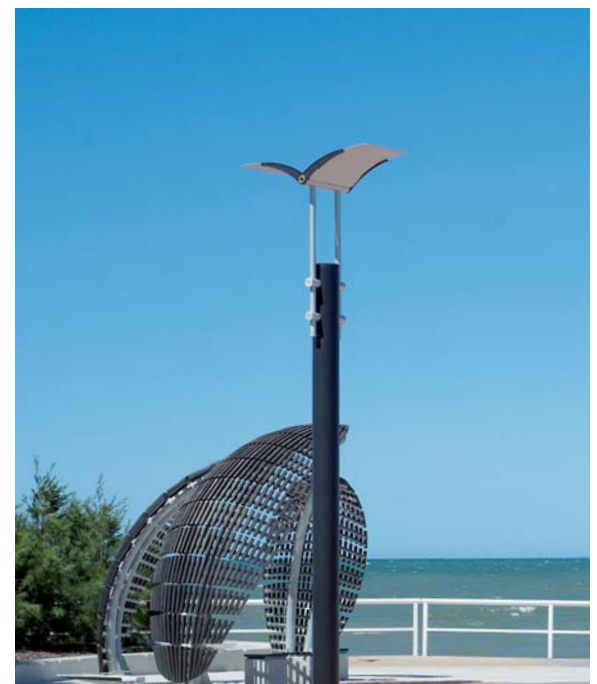
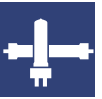

Moora Park Foreshore, Brisbane (AUS). Landscape architect & Lighting design: Neil Ariel, Brisbane City Council Design.

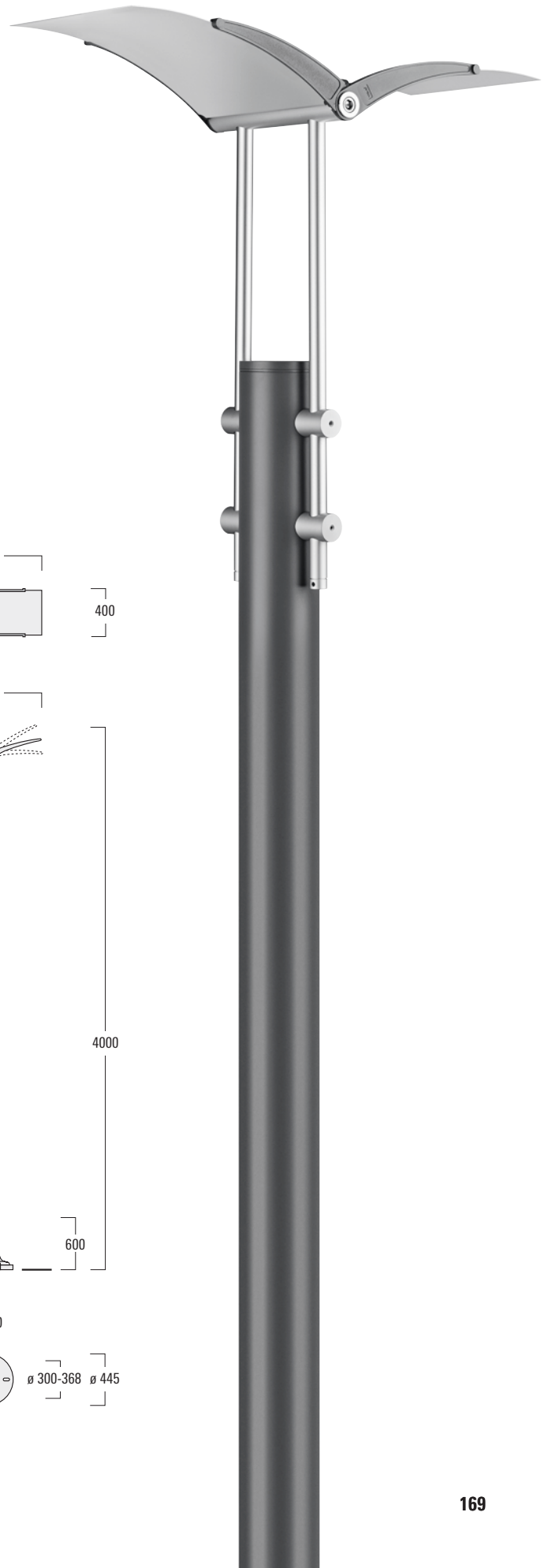

Part ID	Light source	lm	Factor*	kg
LGI440	118-0079 [ECG] HIT-CE 70W G12	7300	1.00	28.5
	118-0084 [ECG] HIT-CE 100W G12	9500	1.30	29.6
	118-0078 [ECG] HIT-CE 150W G12	15000	2.05	29.7

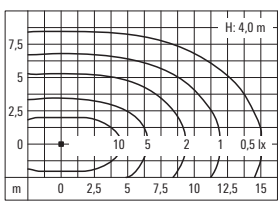
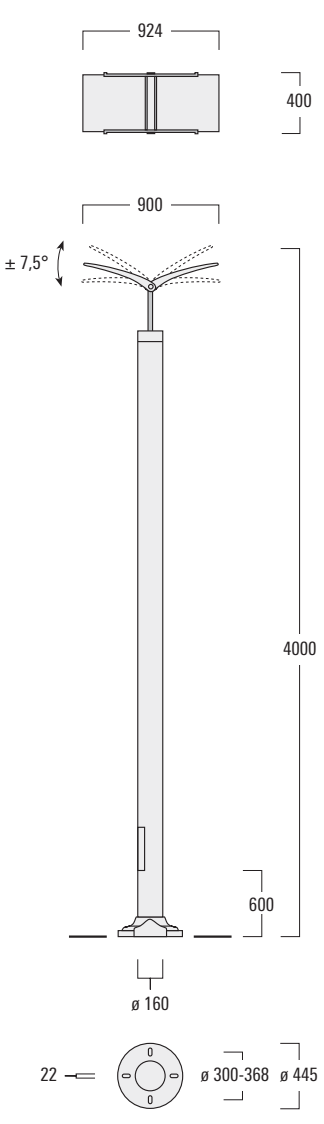

* Multiplier for Isolux value

MOUNTING ACCESSORIES

Planted roots

Galvanised steel, for light columns.

			kg
for LSP / LTP	300-0456	ESD6	10.4
for LSM / LTM / LTC / LCI / LGI	300-0949	ESV10	25.3

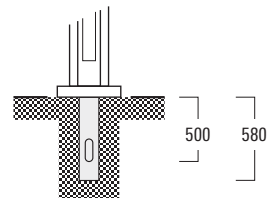

Planted root ESD6

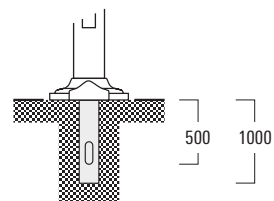

Planted root ESV10

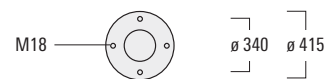



Pier seaside Heiligendamm (D). Lighting design: Institut für Gebäude + Energie + Licht Planung, Prof. Dr.-Ing. Thomas Römhild, Wismar.

IOS® Beam distributions for street and area lighting

- [P65] pedestrian / bicycle lane
- [S60] streetlighting
- [S65] streetlighting
- [S70] streetlighting
- [A60] forward throw, asymmetric
- [R65] rectangular forward throw
- [R] rectangular
- [C50] medium beam, symmetric
- [C60] controlled, symmetric



ZFT400 LED

174



CFT500 LED

190



PFL500 LED

218

Street and area lighting



ACCESSORIES ZFT400
■ Mounting 178



ZA600 LED 180

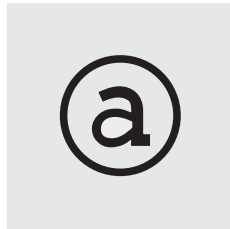

ACCESSORIES ZA600
■ Mounting 182



RMC300 LED 184

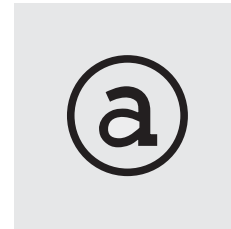

ACCESSORIES RMC300
■ Mounting 186



RMT300 LED 188



RFS500 LED 192



RFL500-SE LED 194



RFL500-SE 198



ACCESSORIES RFL500-SE
■ Mounting 200
■ Optical 204



VFL500 LED 206



ACCESSORIES VFL500
■ Mounting 214

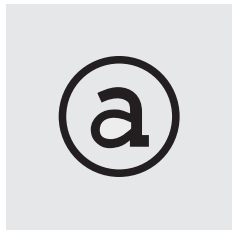

ACCESSORIES PFL500
■ Mounting 222



PFL200 LED 224



PFL200 228



ACCESSORIES PFL200
■ Mounting 232
■ Optical 240



EFL500 LED 242



ACCESSORIES EFL500
■ Mounting 244

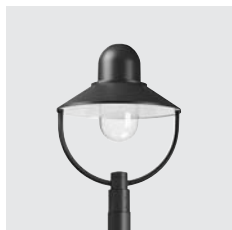

AL500 LED 246



ALP500 LED 248

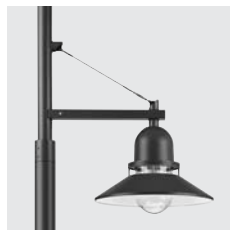

AOP500 LED 250



ASP500 LED 252



BSP500 LED 254



ACCESSORIES
ALP / AOP / ASP / BSP500
■ Mounting 256

ZFT400 SERIES

Post mounted luminaire, symmetric or side or forward throw distribution, asymmetric.

ZFT430 / ZFT 434 / ZFT440 / ZFT444: IP66, SKI. IK09.

ZFT460 / ZFT 464 / ZFT470 / ZFT474: IP66, SKI. IK07.

Marine-grade die-cast aluminium alloy. 5CE superior corrosion protection including PCS hardware. Powdercoat finish in RAL 9004, RAL 9006, RAL 9007 or RAL 9016. Silicone CCG® Controlled Compression Gasket. PMMA cover. Luminaire is factory-sealed and does not need to be opened during installation.

Integral EC electronic converter.

Factory installed LED circuit board. LED boards can be easily removed for upgrading. PMMA OLC® LED lenses or double lens for superior illumination and glare control.

Recommended mounting height 3.0–6.0 m, depending on wattage selected.

Light source

LED 9-54 W, 4000 K,
for 3000 K refer to www.we-ef.com

Light distribution

[C60] [S65] [R65]

Accessories

- Mounting, page 178
- Eco Step Dim®, page 264
- Surge protection, page 374

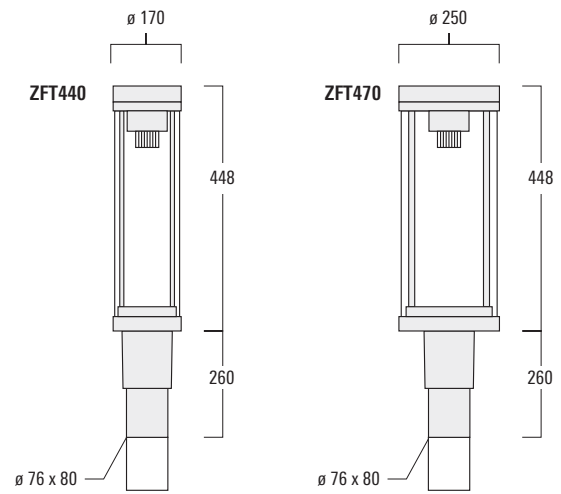
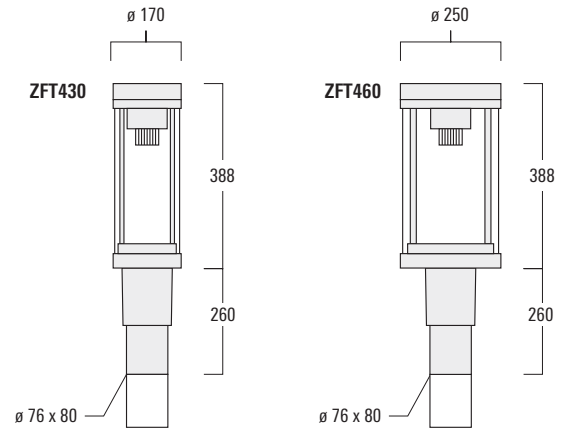

Photo: Double lens [C60]



[C60] Controlled distribution, symmetric

[C60]	Part ID	Light source	K	lm*	Factor**	kg
ZFT430	115-1344	LED-FT 12W	4000	1915	0.49	5.4
	115-1242	LED-FT 24W	4000	3940	1.00	5.4
ZFT440	115-1342	LED-FT 12W	4000	1915	0.49	5.5
	115-1244	LED-FT 24W	4000	3940	1.00	5.5
ZFT460	115-1346	LED-FT 24W	4000	3940	1.00	7.1
	115-1348	LED-FT 37W	4000	5890	1.49	7.1
ZFT470	115-1354	LED-FT 24W	4000	3940	1.00	7.2
	115-1356	LED-FT 37W	4000	5890	1.49	7.2



Optional $\varnothing 60 \times 80$ version available.
Must be indicated during order placement.

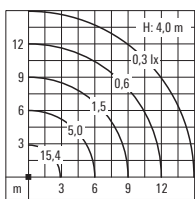

[C60]

* Nominal lumen output based on LED manufacturers data at 25°C T_c. For rated lumens at 25°C T_q and latest data refer to www.we-ef.com.
** Multiplier for Isolux value





Optional accessory:
Bird spikes



Optional accessory:
Wireless antenna for remote control



Optional accessory:
Photocell for ZFT460/464 and ZFT470/474



Photo: OLC® lenses [R65]

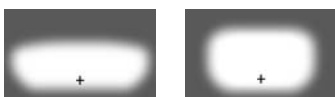

[S65]

[R65]

[S65] Streetlighting distribution

[R65] Rectangular forward throw distribution

[S65]	Part ID	Light source	K	lm*	Factor**	kg
ZFT434	115-1364	9 LED 9W / 350 mA	4000	1211	0.55	5.5
	115-1292	9 LED 18W / 700 mA	4000	2213	1.00	5.5
ZFT444	115-1370	9 LED 9W / 350 mA	4000	1211	0.55	5.6
	115-1372	9 LED 18W / 700 mA	4000	2213	1.00	5.6
ZFT464	115-1311	18 LED 36W / 700 mA	4000	4427	2.00	7.2
	115-1352	18 LED 54W / 1050 mA	4000	8100	3.66	7.2
ZFT474	115-1360	18 LED 36W / 700 mA	4000	4427	2.00	7.3
	115-1315	18 LED 54W / 1050 mA	4000	8100	3.66	7.3

[R65]	Part ID	Light source	K	lm*	Factor**	kg
ZFT434	115-1362	9 LED 9W / 350 mA	4000	1211	0.55	5.5
	115-1288	9 LED 18W / 700 mA	4000	2213	1.00	5.5
ZFT444	115-1366	9 LED 9W / 350 mA	4000	1211	0.55	5.6
	115-1368	9 LED 18W / 700 mA	4000	2213	1.00	5.6
ZFT464	115-1309	18 LED 36W / 700 mA	4000	4427	2.00	7.2
	115-1350	18 LED 54W / 1050 mA	4000	8100	3.66	7.2
ZFT474	115-1358	18 LED 36W / 700 mA	4000	4427	2.00	7.3
	115-1313	18 LED 54W / 1050 mA	4000	8100	3.66	7.3

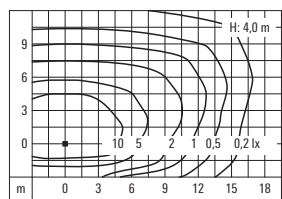

[S65]

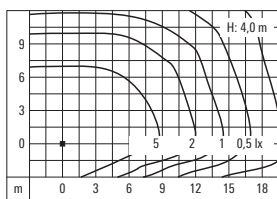

[R65]

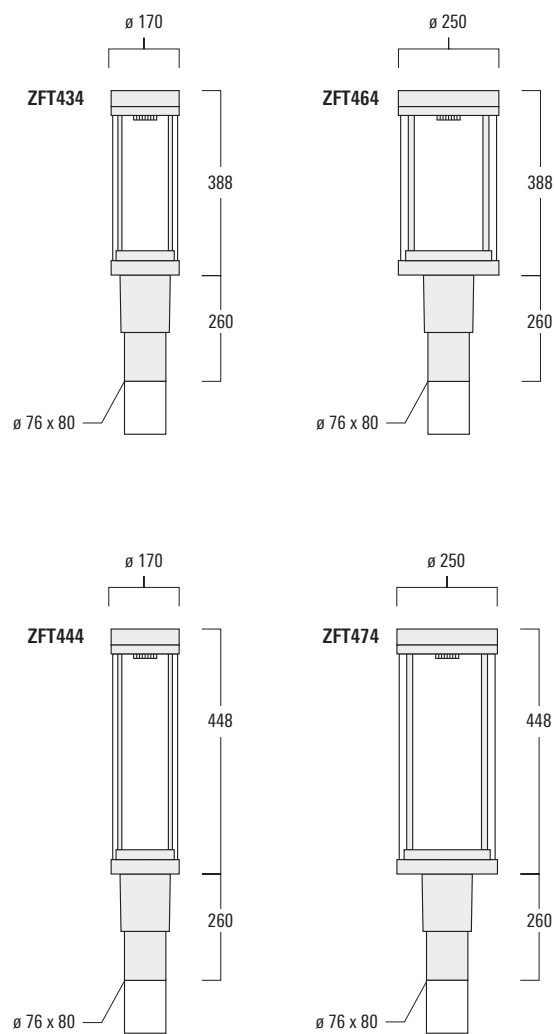

Optional ø 60 x 80 version available.
Must be indicated during order placement.



* Nominal lumen output based on LED manufacturers data at 85°C T_c. For rated lumens at 25°C T_q and latest data refer to www.we-ef.com.

** Multiplier for Isolux value

MOUNTING ACCESSORIES – ZFT400 SERIES

Marine-grade aluminium construction. Powdercoat finish in RAL 9004, RAL 9006, RAL 9007 or RAL 9016.

Wall / Pole brackets RZ Series				D x L	H	C	kg
for ZFT400	115-1324	RZ0-400	Wall bracket	231	277	3.5	
	115-1323	RZ2-400	Pole bracket	∅ 76 x 100	516	4.9	

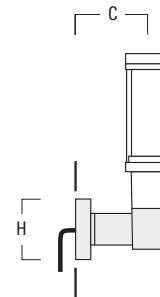

Wall bracket RZ0

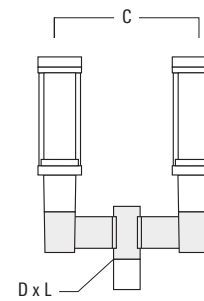

Pole bracket RZ2



ZA600 SERIES

Post mounted luminaire, controlled distribution, symmetric.

IP55, Class I. IK10. Marine-grade die-cast aluminium alloy. 5CE superior corrosion protection including PCS hardware. Powdercoat finish in RAL 9004, RAL 9006, RAL 9007 or RAL 9016. Silicone rubber gaskets. Polycarbonate main lens.

Integral EC electronic converter.

Factory installed LED circuit board. LED boards can be easily removed for upgrading. PMMA double lens for superior illumination and glare control.

Recommended mounting height 3.0–4.5 m, depending on wattage selected.

Light source

LED 17-24 W, 4000 K,
for 3000 K refer to www.we-ef.com

Light distribution

[C60]

Accessories

- Mounting, page 182
- Eco Step Dim[®], page 264
- Surge protection, page 374





[C60] Controlled distribution, symmetric

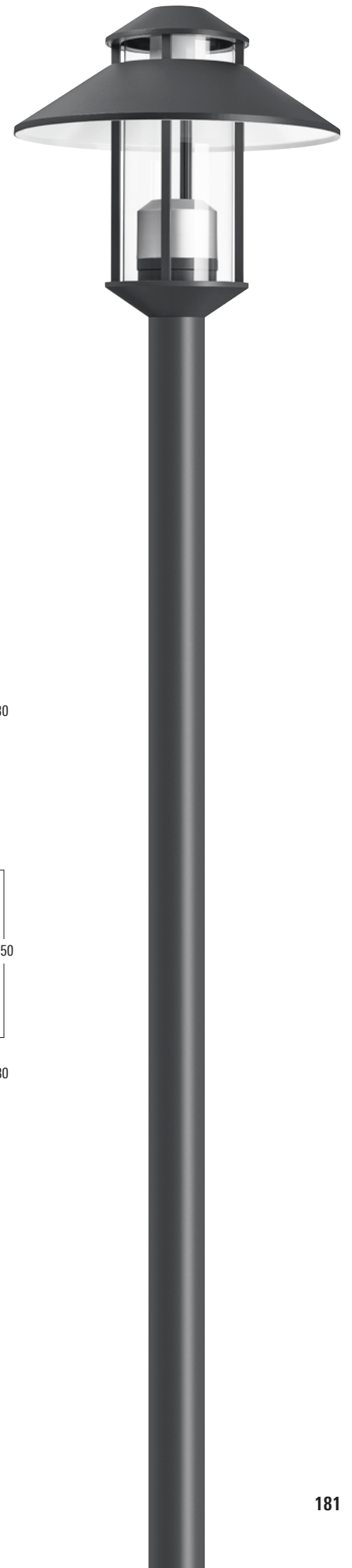

[C60]	Part ID	Light source	K	lm*	Factor**	kg
ZA630	159-0299	LED-FT 17W	4000	2915	1.00	7.7
	159-0307	LED-FT 24W	4000	3940	1.35	7.7
ZA640	159-0303	LED-FT 17W	4000	2915	1.00	9.1
	159-0309	LED-FT 24W	4000	3940	1.35	9.1

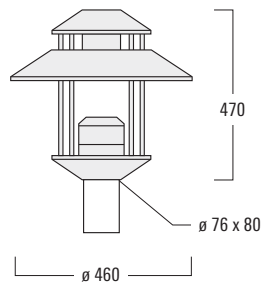

ZA630

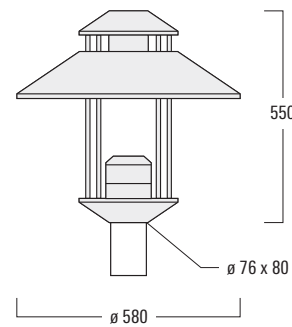

ZA640

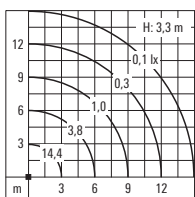

[C60]

* Nominal lumen output based on LED manufacturers data at 25°C T_c. For rated lumens at 25°C T_q and latest data refer to www.we-ef.com.

** Multiplier for Isolux value

MOUNTING ACCESSORIES – ZA600 SERIES

Marine-grade aluminium construction. Powdercoat finish in RAL 9004, RAL 9006, RAL 9007 or RAL 9016.

Wall / Pole brackets AZ Series				C	kg
for ZA630	155-0269	AZ0-300	Wall bracket	300	3.6
	155-0550	AZ20-300	Pole bracket	300	6.2
	155-0551	AZ30-300	Pole bracket	300	8.6
for ZA640	155-0266	AZ0-400	Wall bracket	400	4.0
	155-0304	AZ20-400	Pole bracket	400	7.0
	155-0306	AZ30-400	Pole bracket	400	9.8

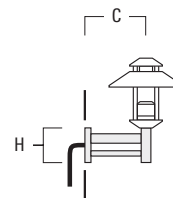

Wall bracket AZ0

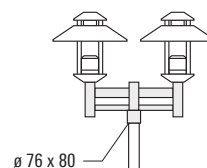

Pole bracket AZ20

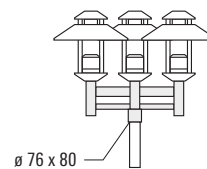

Pole bracket AZ30



Endeavour Bridge, Whitianga Waterways. Whitianga (NZ)

RMC300 SERIES

Post mounted luminaire, side or forward throw distribution, asymmetric and pedestrian/bicycle lane distribution.

IP66. Class I. IK08. Marine-grade, die-cast aluminium alloy. 5CE superior corrosion protection including PCS hardware. Powdercoat finish in RAL 9004, RAL 9006, RAL 9007 or RAL 9016. RFC® Reflection Free Contour cover. Silicone CCG® Controlled Compression Gasket. Luminaire is factory-sealed and does not need to be opened during installation.

Integral EC electronic converter.

Factory installed LED circuit board. LED boards can be easily removed for upgrading. PMMA OLC® LED lenses for superior illumination and glare control.

Maximum spacing for streetlighting applications depends on wattage and light distribution: 5.5 to 9 times the mounting height. Recommended mounting height 3.0–5.0 m, depending on wattage selected.

Light source

LED 18-54 W, 4000 K,
for 3000 K refer to www.we-ef.com

Light distributions

[P65] [S65] [R65]

Accessories

- Mounting, page 186
- Eco Step Dim®, page 264
- Surge protection, page 374





[P65]

[S65]

[R65]

[P65] Pedestrian / bicycle lane distribution

[S65] Streetlighting distribution

[R65] Rectangular forward throw distribution

[P65]	Part ID	Light source	K	lm*	Factor**	kg
RMC320	105-0101	18 LED 18W / 350 mA	4000	2421	0.55	7.5
	105-0103	18 LED 36W / 700 mA	4000	4427	1.00	7.5
	105-0105	18 LED 54W / 1050 mA	4000	8100	1.83	7.5

[S65]	Part ID	Light source	K	lm*	Factor**	kg
RMC320	105-9790	18 LED 18W / 350 mA	4000	2421	0.55	7.5
	105-9791	18 LED 36W / 700 mA	4000	4427	1.00	7.5
	105-9792	18 LED 54W / 1050 mA	4000	8100	1.83	7.5

[R65]	Part ID	Light source	K	lm*	Factor**	kg
RMC320	105-9835	18 LED 18W / 350 mA	4000	2421	0.57	7.5
	105-9836	18 LED 36W / 700 mA	4000	4427	1.00	7.5
	105-9837	18 LED 54W / 1050 mA	4000	8100	1.49	7.5

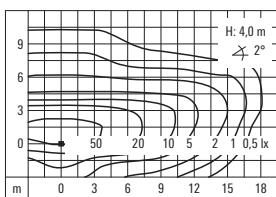
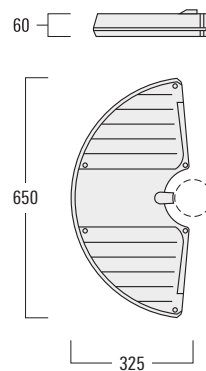

[P65]

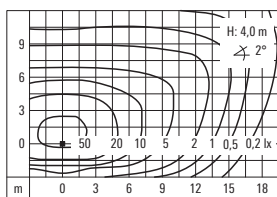

[S65]

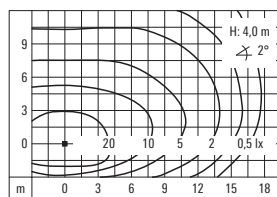

[R65]

* Nominal lumen output based on LED manufacturers data at 85°C T_J. For rated lumens at 25°C T_q and latest data refer to www.we-ef.com.

** Multiplier for Isolux value

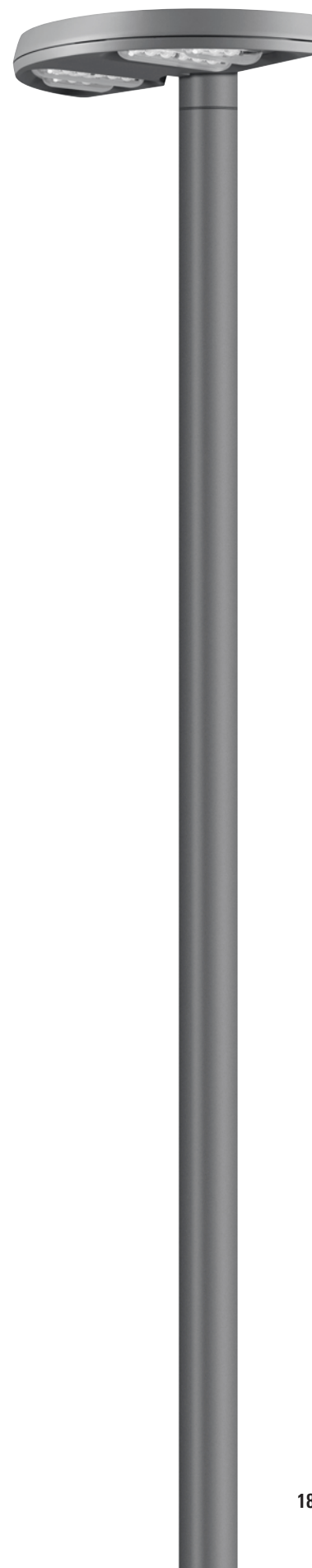

MOUNTING ACCESSORIES – RMC300 SERIES

Marine-grade aluminium construction. Powdercoat finish in RAL 9004, RAL 9006, RAL 9007 or RAL 9016.

Wall / Pole brackets RM Series				D x L	kg
for RMC320	105-9845	RM1-S	Short bracket		0.6
	105-9846	RM1-W	Wall bracket		1.3
	105-9847	RM1-76	Pole bracket	ø 76 x 80	1.0
	105-9848	RM2-76	Pole bracket	ø 76 x 80	1.0

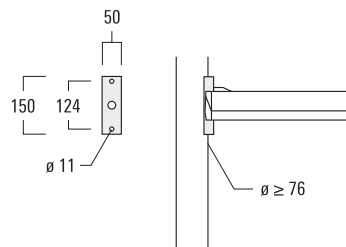

Short bracket RM1-S

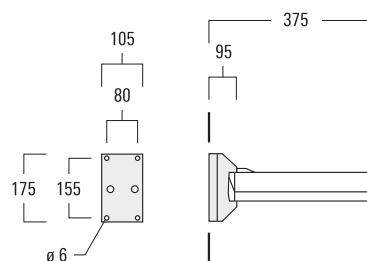

Wall bracket RM1-W

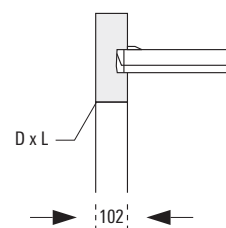

Pole bracket RM1-76

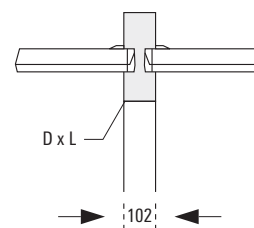

Pole bracket RM2-76



RMT300 SERIES

Post mounted luminaire, side or rectangular forward throw distribution, asymmetric and pedestrian/bicycle lane distribution, two-sided.

IP66. Class I. IK09. Marine-grade, die-cast aluminium alloy. 5CE superior corrosion protection including PCS hardware. Powdercoat finish in RAL 9004, RAL 9006, RAL 9007 or RAL 9016. RFC® Reflection Free Contour cover. Silicone CCG® Controlled Compression Gasket. Luminaire is factory-sealed and does not need to be opened during installation.

Integral EC electronic converter.

Factory installed LED circuit board. LED boards can be easily removed for upgrading. PMMA OLC® LED lenses for superior illumination and glare control.

Maximum spacing for streetlighting applications depends on wattage and light distribution: 5.5 to 9 times the mounting height. Recommended mounting height 3.0–5.0 m, depending on wattage selected.

Light source

LED 24-72 W, 4000 K,
for 3000 K refer to www.we-ef.com

Light distributions

[P65] [S65] [R65]

Accessories

- Eco Step Dim®, page 264
- Surge protection, page 374





[P65] two-sided [S65] two-sided [R65] two-sided

[P65] Pedestrian / bicycle lane distribution, two sided

[S65] Streetlighting distribution, two sided

[R65] Rectangular forward throw distribution, two-sided

[P65] two-sided	Part ID	Light source	K	lm*	Factor**	kg
RMT320	105-7028	24 LED 24W / 350 mA	4000	3228	0.51	8.5
	105-7029	24 LED 48W / 700 mA	4000	5903	1.00	8.5
	105-7034	24 LED 72W / 1050 mA	4000	10800	1.83	8.5

[S65] two-sided	Part ID	Light source	K	lm*	Factor**	kg
RMT320	105-9886	24 LED 24W / 350 mA	4000	3228	0.51	8.5
	105-9887	24 LED 48W / 700 mA	4000	5903	1.00	8.5
	105-9938	24 LED 72W / 1050 mA	4000	10800	1.83	8.5

[R65] two-sided	Part ID	Light source	K	lm*	Factor**	kg
RMT320	105-9926	24 LED 24W / 350 mA	4000	3228	0.51	8.5
	105-9927	24 LED 48W / 700 mA	4000	5903	1.00	8.5
	105-7046	24 LED 72W / 1050 mA	4000	10800	1.83	8.5

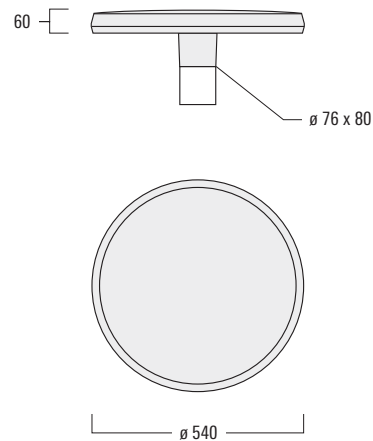

Optional ø 60 x 80 version available.
Must be indicated during order placement.

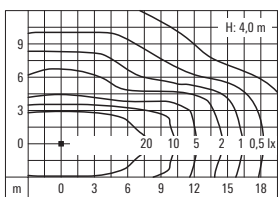

[P65] two-sided

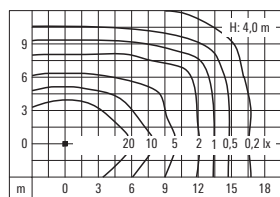

[S65] two-sided

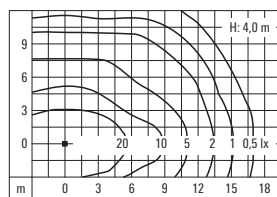

[R65] two-sided

* Nominal lumen output based on LED manufacturers data at 85°C T_J. For rated lumens at 25°C T_q and latest data refer to www.we-ef.com.

** Multiplier for Isolux value

CFT500 SERIES

Post mounted luminaire, medium beam, symmetric or rectangular distribution.

IP66. Class I. IK08. Marine-grade, die-cast aluminium alloy. 5CE superior corrosion protection including PCS hardware. Powdercoat finish in RAL 9004, RAL 9006, RAL 9007 or RAL 9016. Silicone CCG® Controlled Compression Gasket. PMMA RFC® Reflection Free Contour cover. The luminaire is factory sealed and does not need to be opened during installation.

Integral EC electronic converter.

Factory installed LED circuit board. LED boards can be easily removed for upgrading.

PMMA OLC® LED lenses for superior illumination and glare control.

Recommended mounting height 3.0–6.0 m, depending on wattage selected.

Light source

LED 24-108 W, 4000 K,
for 3000 K refer to www.we-ef.com

Light distributions

[C50] [R]

Accessories

- Eco Step Dim®, page 264
- Surge protection, page 374
- Poles, page 386



reddot award 2015
winner



Focus Open 2015
Silver



WE-EF LEUCHTEN Head Office. Bispingen (D). Architect: Braunholz Architekten. Lighting design: Ulrike Brandt Licht.

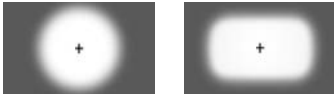

[C50]

[R]

[C50] Medium beam distribution, symmetric

[R] Rectangular distribution

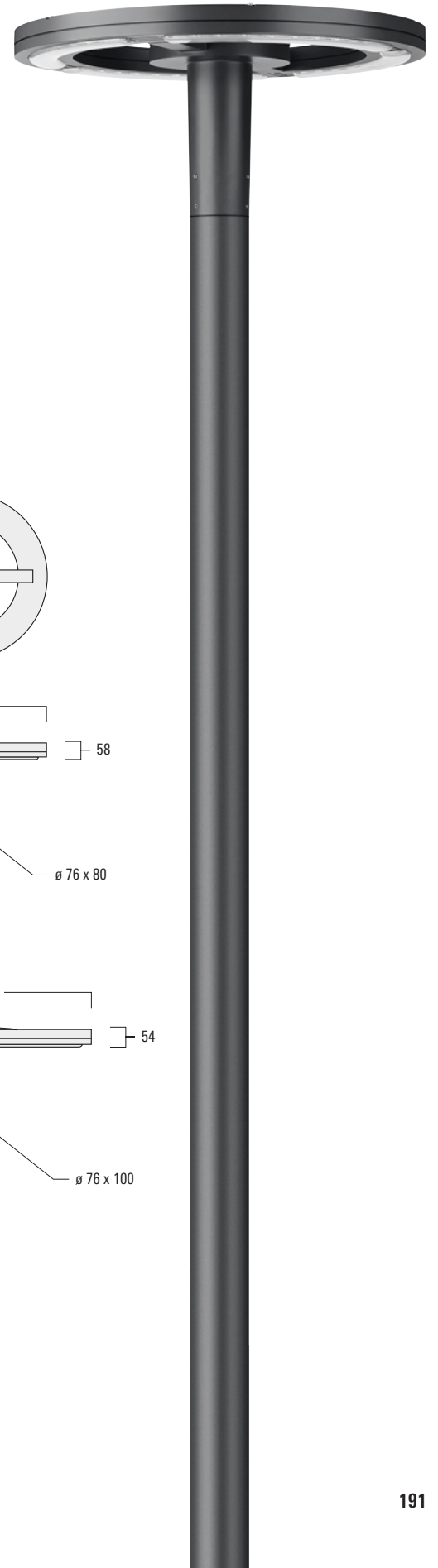

[C50]	Part ID	Light source	K	lm*	Factor**	kg
CFT530	105-0093	24 LED 24 W / 350 mA	4000	3228	0.67	9.8
	105-0097	24 LED 48 W / 700 mA	4000	5903	1.22	9.8
CFT540	105-0077	36 LED 36W / 350 mA	4000	4842	1.00	13.3
	105-0079	36 LED 72W / 700 mA	4000	8854	1.83	13.3
	105-0081	36 LED 108W / 1050 mA	4000	16200	3.35	13.3

[R]	Part ID	Light source	K	lm*	Factor**	kg
CFT530	105-0095	24 LED 24 W / 350 mA	4000	3228	0.67	9.8
	105-0099	24 LED 48 W / 700 mA	4000	5903	1.22	9.8
CFT540	105-0083	36 LED 36W / 350 mA	4000	4842	1.00	13.3
	105-0085	36 LED 72W / 700 mA	4000	8854	1.83	13.3
	105-0087	36 LED 108W / 1050 mA	4000	16200	3.35	13.3

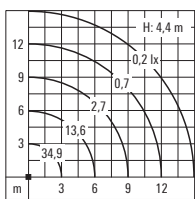
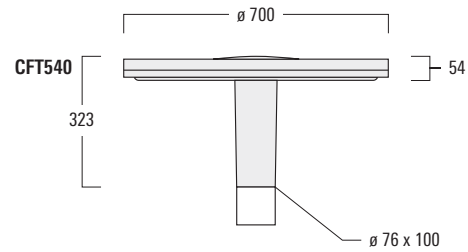
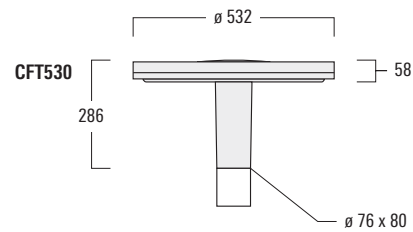
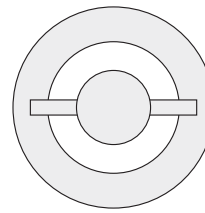

[C50]

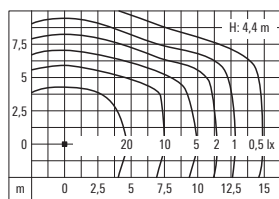

[R]

* Nominal lumen output based on LED manufacturers data at 85°C T_J. For rated lumens at 25°C T_q and latest data refer to www.we-ef.com.

** Multiplier for Isolux value

RFS500 SERIES

Catenary mounted luminaire, side throw distribution, asymmetric, two-sided.

IP66. Class I. IK07. Marine-grade, die-cast aluminium alloy. 5CE superior corrosion protection including PCS hardware. Powdercoat finish in RAL 9004, RAL 9006, RAL 9007 or RAL 9016. Silicone CCG® Controlled Compression Gasket. Non-reflecting safety glass lens, hinged.

Includes cable connector, for cable 6-12 mm. Cable inclination angle: Maximum 10°.

Integral EC electronic converter.

Factory installed LED circuit board. LED boards can be easily removed for upgrading. PMMA OLC® LED lenses for superior illumination and glare control.

Maximum spacing, for streetlighting applications, depends on wattage and light distribution: 5.5 up to 9 times the mounting height. Recommended mounting height 3.0–6.0 m, depending on wattage selected.

Light source

LED 12-96 W, 4000 K,
for 3000 K refer to www.we-ef.com

Light distributions

[S60] [S65] [S70]

Accessories

- Eco Step Dim®, page 264
- Surge protection, page 374



Train station TGV Belfort-Montbéliard (F)

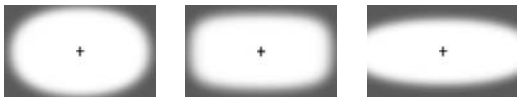

[S60] two-sided

[S65] two-sided

[S70] two-sided

[S60] Streetlighting distribution, two-sided

[S65] Streetlighting distribution, two-sided

[S70] Streetlighting distribution, two-sided



[S60] two-sided	Part ID	Light source	K	lm*	Factor**	kg
RFS530	111-0707	12 LED 12W / 350 mA	4000	1614	0.29	11.6
	111-0719	12 LED 24W / 700 mA	4000	2951	0.50	11.6
	111-0709	24 LED 24W / 350 mA	4000	3228	0.58	11.9
	111-0697	24 LED 48W / 700 mA	4000	5903	1.00	11.9
RFS540	111-0440	36 LED 36W / 350 mA	4000	4842	0.86	14.7
	111-0623	36 LED 72W / 700 mA	4000	8854	1.50	14.7
	111-0441	48 LED 48W / 350 mA	4000	6456	1.15	15.0
	111-0403	48 LED 96W / 700 mA	4000	11805	2.00	15.0

[S65] two-sided	Part ID	Light source	K	lm*	Factor**	kg
RFS530	111-0711	12 LED 12W / 350 mA	4000	1614	0.29	11.6
	111-0722	12 LED 24W / 700 mA	4000	2951	0.50	11.6
	111-0713	24 LED 24W / 350 mA	4000	3228	0.58	11.9
	111-0724	24 LED 48W / 700 mA	4000	5903	1.00	11.9
RFS540	111-0442	36 LED 36W / 350 mA	4000	4842	0.86	14.7
	111-0702	36 LED 72W / 700 mA	4000	8854	1.50	14.7
	111-0443	48 LED 48W / 350 mA	4000	6456	1.15	15.0
	111-0704	48 LED 96W / 700 mA	4000	11805	2.00	15.0

[S70] two-sided	Part ID	Light source	K	lm*	Factor**	kg
RFS530	111-0715	12 LED 12W / 350 mA	4000	1614	0.29	11.6
	111-0726	12 LED 24W / 700 mA	4000	2951	0.50	11.6
	111-0717	24 LED 24W / 350 mA	4000	3228	0.58	11.9
	111-0728	24 LED 48W / 700 mA	4000	5903	1.00	11.9
RFS540	111-0444	36 LED 36W / 350 mA	4000	4842	0.86	14.7
	111-0402	36 LED 72W / 700 mA	4000	8854	1.50	14.7
	111-0629	48 LED 48W / 350 mA	4000	6456	1.15	15.0
	111-0593	48 LED 96W / 700 mA	4000	11805	2.00	15.0

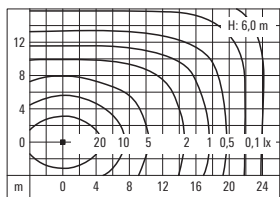

[S60] two-sided

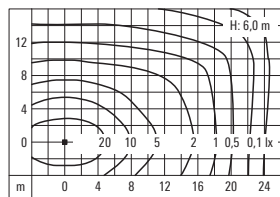

[S65] two-sided

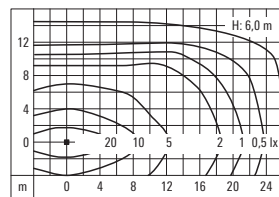

[S70] two-sided

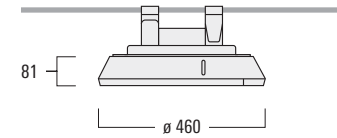

RFS530

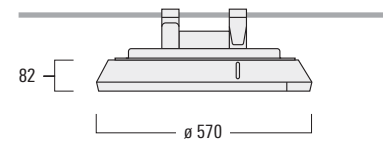
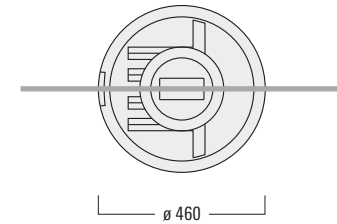

RFS540

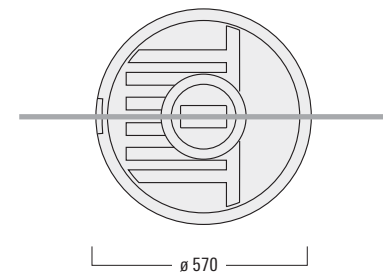

* Nominal lumen output based on LED manufacturers data at 85°C T_j. For rated lumens at 25°C T_j and latest data refer to www.we-ef.com.

** Multiplier for Isolux value

RFL500-SE SERIES

Post mounted luminaire, side or forward throw distribution, asymmetric and pedestrian/bicycle lane distribution.

IP66. Class I. IK07. Marine-grade, die-cast aluminium alloy. 5CE superior corrosion protection including PCS hardware. Powdercoat finish in RAL 9004, RAL 9006, RAL 9007 or RAL 9016. Silicone CCG® Controlled Compression Gasket. Non-reflecting safety glass lens, hinged. The luminaire is factory sealed and does not need to be opened during installation.

Integral EC electronic converter.

Factory installed LED circuit board. LED boards can be easily removed for upgrading. PMMA OLC® LED lenses for superior illumination and glare control.

Maximum spacing, for streetlighting applications, depends on wattage and light distribution: 5.5 up to 9 times the mounting height. Recommended mounting height 3.0–6.0 m, depending on wattage selected.

Light source

LED 12-96 W, 4000 K,
for 3000 K refer to www.we-ef.com

Light distributions

[P65] [S60] [S65] [S70] [A60] [R65]

Accessories

- Mounting, page 200
- Eco Step Dim®, page 264
- Surge protection, page 374



Residential area Zauberwinkel. Poing (D). Planning: Südhausbau München.

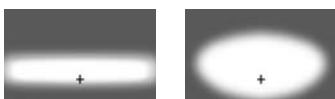

[P65]

[S60]

[P65] Pedestrian / bicycle lane distribution

[S60] Streetlighting distribution



[P65]	Part ID	Light source	K	lm*	Factor**	kg
RFL530-SE	111-0821	12 LED 12W / 350 mA	4000	1614	0.29	9.3
	111-0822	12 LED 24W / 700 mA	4000	2951	0.50	9.3
	111-0823	24 LED 24W / 350 mA	4000	3228	0.58	9.3
	111-0824	24 LED 48W / 700 mA	4000	5903	1.00	9.3

[S60]	Part ID	Light source	K	lm*	Factor**	kg
RFL530-SE	111-0406	12 LED 12W / 350 mA	4000	1614	0.29	9.3
	111-0337	12 LED 24W / 700 mA	4000	2951	0.50	9.3
	111-0407	24 LED 24W / 350 mA	4000	3228	0.58	9.3
	111-0339	24 LED 48W / 700 mA	4000	5903	1.00	9.3
RFL540-SE	111-0420	36 LED 36W / 350 mA	4000	4842	0.86	15.0
	111-0341	36 LED 72W / 700 mA	4000	8854	1.50	15.0
	111-0421	48 LED 48W / 350 mA	4000	6456	1.15	15.0
	111-0343	48 LED 96W / 700 mA	4000	11805	2.00	15.0

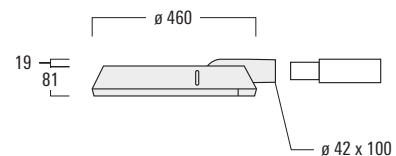

RFL530-SE

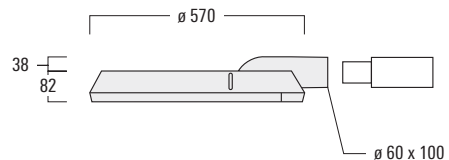

RFL540-SE

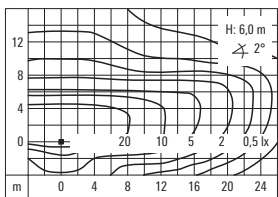

[P65]

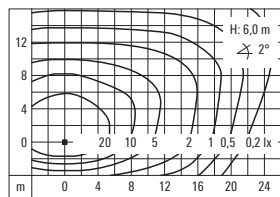

[S60]

* Nominal lumen output based on LED manufacturers data at 85°C T_J. For rated lumens at 25°C T_q and latest data refer to www.we-ef.com.

** Multiplier for Isolux value

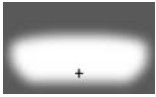

[S65]

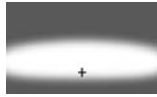

[S70]

[S65] Streetlighting distribution

[S70] Streetlighting distribution

[S65]	Part ID	Light source	K	lm*	Factor**	kg
RFL530-SE	111-0408	12 LED 12W / 350 mA	4000	1614	0.29	9.3
	111-0409	12 LED 24W / 700 mA	4000	2951	0.50	9.3
	111-0410	24 LED 24W / 350 mA	4000	3228	0.58	9.3
	111-0411	24 LED 48W / 700 mA	4000	5903	1.00	9.3
RFL540-SE	111-0422	36 LED 36W / 350 mA	4000	4842	0.86	15.0
	111-0423	36 LED 72W / 700 mA	4000	8854	1.50	15.0
	111-0424	48 LED 48W / 350 mA	4000	6456	1.15	15.0
	111-0425	48 LED 96W / 700 mA	4000	11805	2.00	15.0

[S70]	Part ID	Light source	K	lm*	Factor**	kg
RFL530-SE	111-0412	12 LED 12W / 350 mA	4000	1614	0.29	9.3
	111-0345	12 LED 24W / 700 mA	4000	2951	0.50	9.3
	111-0413	24 LED 24W / 350 mA	4000	3228	0.58	9.3
	111-0347	24 LED 48W / 700 mA	4000	5903	1.00	9.3
RFL540-SE	111-0426	36 LED 36W / 350 mA	4000	4842	0.86	15.0
	111-0349	36 LED 72W / 700 mA	4000	8854	1.50	15.0
	111-0427	48 LED 48W / 350 mA	4000	6456	1.15	15.0
	111-0351	48 LED 96W / 700 mA	4000	11805	2.00	15.0

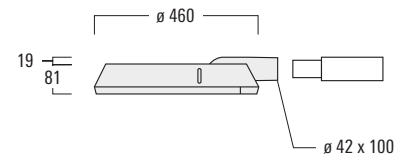

RFL530-SE

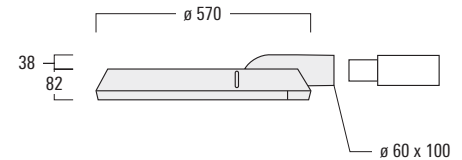

RFL540-SE

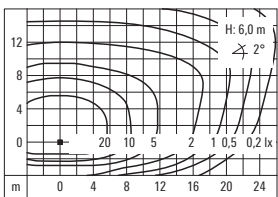

[S65]

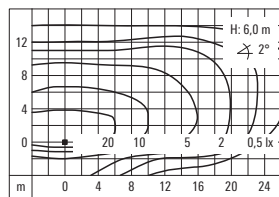

[S70]



[A60]

[R65]

[A60] Forward throw distribution, asymmetric

[R65] Rectangular forward throw distribution



[A60]	Part ID	Light source	K	lm*	Factor**	kg
RFL530-SE	111-0414	12 LED 12W / 350 mA	4000	1614	0.29	9.3
	111-0353	12 LED 24W / 700 mA	4000	2951	0.50	9.3
	111-0415	24 LED 24W / 350 mA	4000	3228	0.58	9.3
	111-0355	24 LED 48W / 700 mA	4000	5903	1.00	9.3
RFL540-SE	111-0428	36 LED 36W / 350 mA	4000	4842	0.86	15.0
	111-0357	36 LED 72W / 700 mA	4000	8854	1.50	15.0
	111-0429	48 LED 48W / 350 mA	4000	6456	1.15	15.0
	111-0359	48 LED 96W / 700 mA	4000	11805	2.00	15.0

[R65]	Part ID	Light source	K	lm*	Factor**	kg
RFL530-SE	111-0416	12 LED 12W / 350 mA	4000	1614	0.29	9.3
	111-0417	12 LED 24W / 700 mA	4000	2951	0.50	9.3
	111-0418	24 LED 24W / 350 mA	4000	3228	0.58	9.3
	111-0419	24 LED 48W / 700 mA	4000	5903	1.00	9.3
RFL540-SE	111-0430	36 LED 36W / 350 mA	4000	4842	0.86	15.0
	111-0431	36 LED 72W / 700 mA	4000	8854	1.50	15.0
	111-0432	48 LED 48W / 350 mA	4000	6456	1.15	15.0
	111-0433	48 LED 96W / 700 mA	4000	11805	2.00	15.0

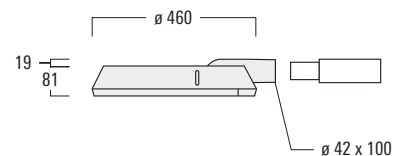

RFL530-SE

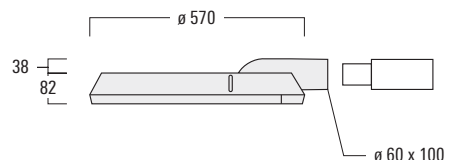

RFL540-SE

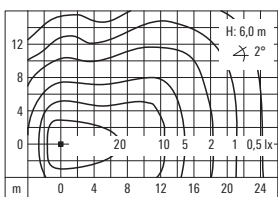

[A60]

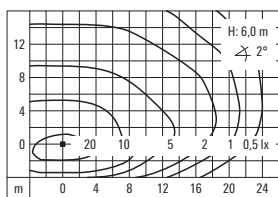

[R65]

* Nominal lumen output based on LED manufacturers data at 85°C T_J. For rated lumens at 25°C T_q and latest data refer to www.we-ef.com.

** Multiplier for Isolux value

RFL500-SE SERIES

Post mounted luminaire, side or forward throw distribution, asymmetric.

IP66, Class I. IK07. Marine-grade die-cast aluminium alloy. 5CE superior corrosion protection including PCS hardware. Powdercoat finish in RAL 9004, RAL 9006, RAL 9007 or RAL 9016. Silicone rubber gaskets. Safety glass lens, hinged.

Integral ECG control gear on hinged and 'no tool' removable gear tray. Anodised aluminium reflector, for beam efficiency and glare control. 'No tool' lamp replacement.

Recommended mounting height 3.0–6.0 m, depending on wattage selected. Mounting brackets to be ordered separately.

Light source
HIT 20-150 W

Light distributions
[S60] [A60]

Accessories

■ Mounting, page 200

■ Optical, page 204

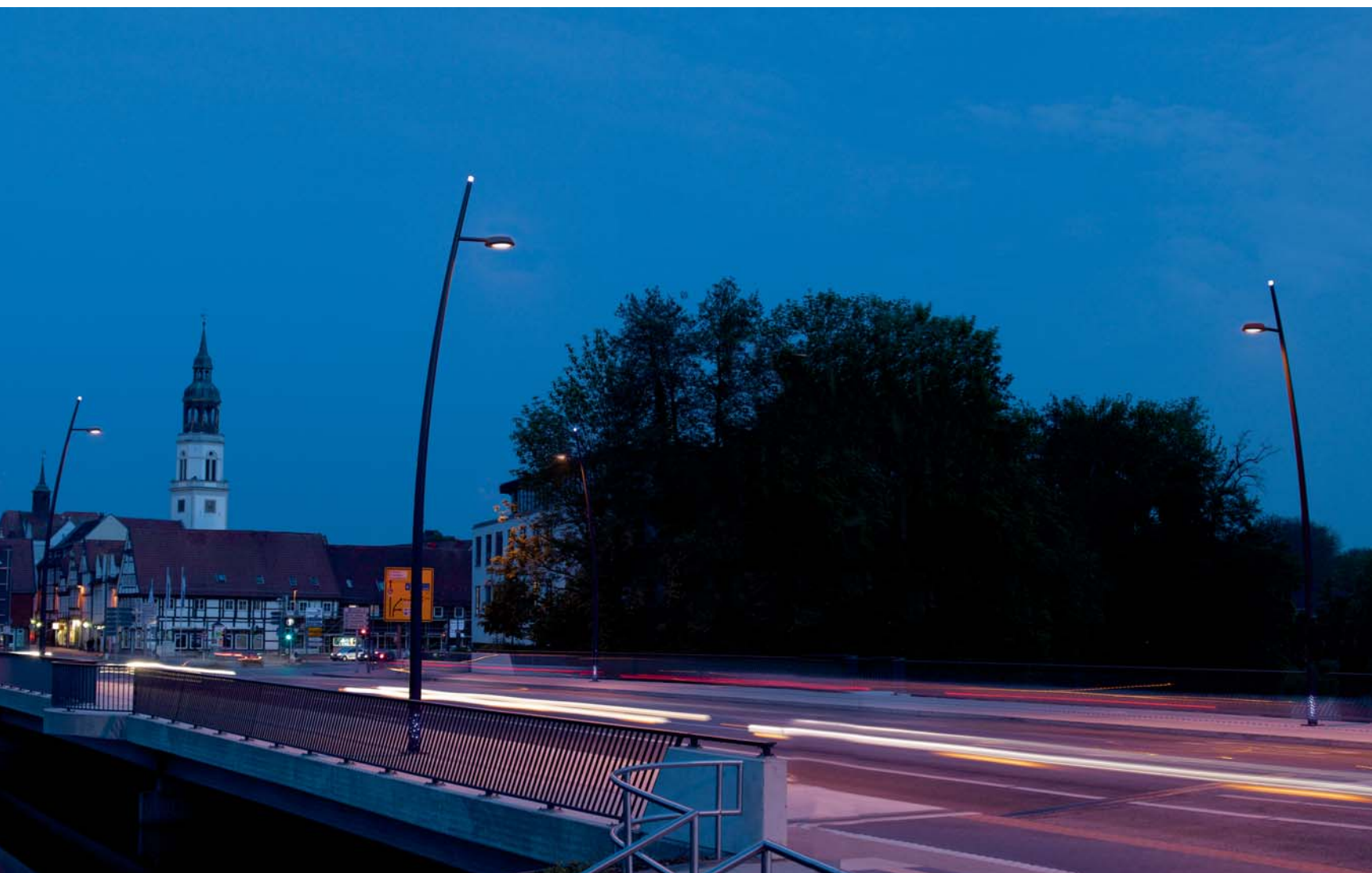

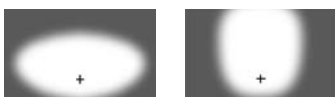

[S60]

[A60]

[S60] Side throw distribution, asymmetric

[A60] Forward throw distribution, asymmetric



[S60]	Part ID	Light source	lm	Factor*	kg
RFL530-SE	111-0003 [ECG]	HIT-COS 45W PGZ12	4300	0.59	9.2
	111-0004 [ECG]	HIT-COS 60W PGZ12	6850	0.94	9.2
	111-0126 [ECG]	HIT-CE 20W G12	1650	0.23	8.6
	111-0005 [ECG]	HIT-CE 35W G12	3600	0.49	8.6
	111-0006 [ECG]	HIT-CE 70W G12	7300	1.00	8.6
RFL540-SE	111-0017 [ECG]	HIT-COS 90W PGZ12	10450	1.43	12.2
	111-0018 [ECG]	HIT-COS 140W PGZ12	16500	2.26	12.6
	111-0019 [ECG]	HIT-CE 150W E40	14500	1.99	11.3

[A60]	Part ID	Light source	lm	Factor*	kg
RFL530-SE	111-0009 [ECG]	HIT-COS 45W PGZ12	4300	0.59	9.2
	111-0010 [ECG]	HIT-COS 60W PGZ12	6850	0.94	9.2
	111-0128 [ECG]	HIT-CE 20W G12	1650	0.23	8.6
	111-0011 [ECG]	HIT-CE 35W G12	3600	0.49	8.6
	111-0012 [ECG]	HIT-CE 70W G12	7300	1.00	8.6
RFL540-SE	111-0023 [ECG]	HIT-COS 90W PGZ12	10450	1.43	12.2
	111-0024 [ECG]	HIT-COS 140W PGZ12	16500	2.26	12.6
	111-0025 [ECG]	HIT-CE 150W E40	14500	1.99	11.4

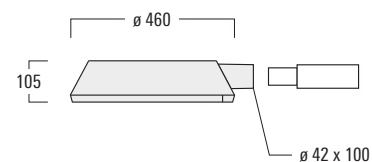

RFL530-SE

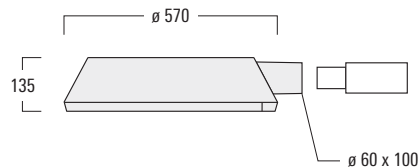

RFL540-SE

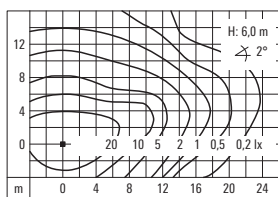

[S60]

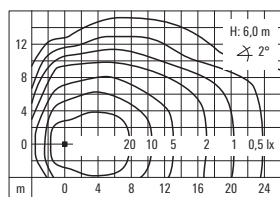

[A60]

* Multiplier for Isolux value

MOUNTING ACCESSORIES – RFL500-SE SERIES

Marine-grade aluminium construction. Powdercoat finish in RAL 9004, RAL 9006, RAL 9007 or RAL 9016.

Wall / Pole brackets RE Series				D x L	D / D1	H	C	kg
for RFL530	111-0052	RE0-530	Wall bracket	230 / 195		180	2.9	
	111-0040	RE1-530	Pole bracket	∅ 76 x 80		400	180	3.2
	111-0041	RE2-530	Pole bracket	∅ 76 x 80		400	180	3.6
for RFL540	111-0084	RE0-540	Wall bracket	230 / 195		180	3.2	
	111-0042	RE1-540	Pole bracket	∅ 76 x 130		550	200	4.6
	111-0043	RE2-540	Pole bracket	∅ 76 x 130		550	200	5.3

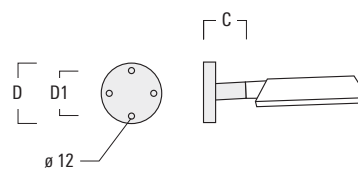

Wall bracket RE0

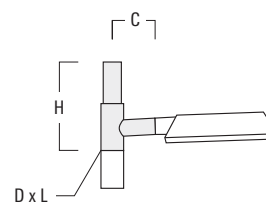

Pole bracket RE1

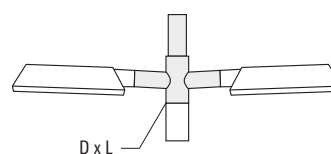

Pole bracket RE2

Pole brackets RF Series				D x L	H	C	kg
for RFL530	111-0044	RF1-530	Pole bracket	∅ 76 x 80	275	190	2.3
	111-0045	RF2-530	Pole bracket	∅ 76 x 80	275	190	3.0
for RFL540	111-0046	RF1-540	Pole bracket	∅ 76 x 80	300	200	2.6
	111-0047	RF2-540	Pole bracket	∅ 76 x 80	300	200	3.3

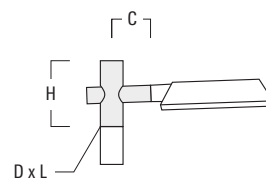

Pole bracket RF1

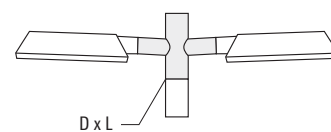

Pole bracket RF2

Tilt brackets TB Series				L	D1 / D2	Angle	kg
for RFL530	111-0639	TB-530.42.10	Tilt bracket*	205	∅ 42x90 / ∅ 42x100	7°	0.5
	111-0640	TB-530.42.15	Tilt bracket*	205	∅ 42x90 / ∅ 42x100	13°	0.5
for RFL540	111-0636	TB-540.60.10	Tilt bracket*	205	∅ 60x90 / ∅ 60x100	7°	0.7
	111-0637	TB-540.60.15	Tilt bracket*	205	∅ 60x90 / ∅ 60x100	13°	0.7

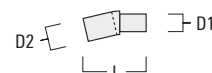

Tilt bracket TB

* for adjusting luminaire angle



Residential area Graylingwell Park, Chichester (UK). Architect: John Thompson and Partners. Landscape Architect: Studio Engleback.

MOUNTING ACCESSORIES – RFL500-SE SERIES

Marine-grade aluminium construction. Powdercoat finish in RAL 9004, RAL 9006, RAL 9007 or RAL 9016.

Wall / Pole brackets RX Series				D x L	H / H1	H	C	kg
for RFL530	111-0053	RX0-530	Wall bracket	350 / 285		710	3.3	
	111-0088	RX1-530	Pole bracket	∅ 76 x 80		400	710	4.5
	111-0089	RX2-530	Pole bracket	∅ 76 x 80		400	710	6.2
for RFL540	111-0086	RX0-540	Wall bracket	450 / 385		1000	5.2	
	111-0054	RX1-540	Pole bracket	∅ 76 x 130		550	1000	6.8
	111-0055	RX2-540	Pole bracket	∅ 76 x 130		550	1000	9.7

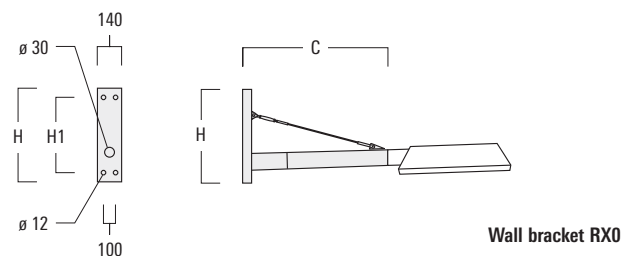

Wall bracket RX0

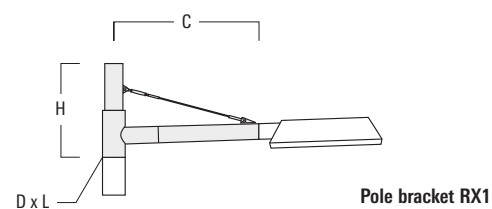

Pole bracket RX1

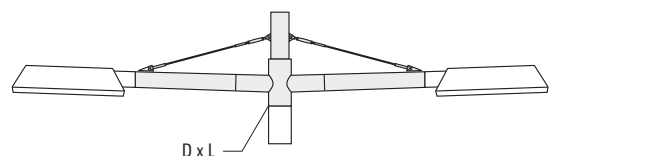

Pole bracket RX2

Wall / Pole brackets RI Series				D*	C	kg
for RFL530	111-0178	RI-530	Wall / pole bracket	∅ 102-133	96	1.5
for RFL540	111-0179	RI-540	Wall / pole bracket	∅ 102-133	110	1.5

* Pole diameter (structural limitations of pole must be considered)

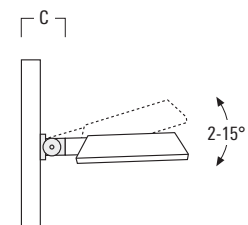

Bracket RI -
pole & wall installation

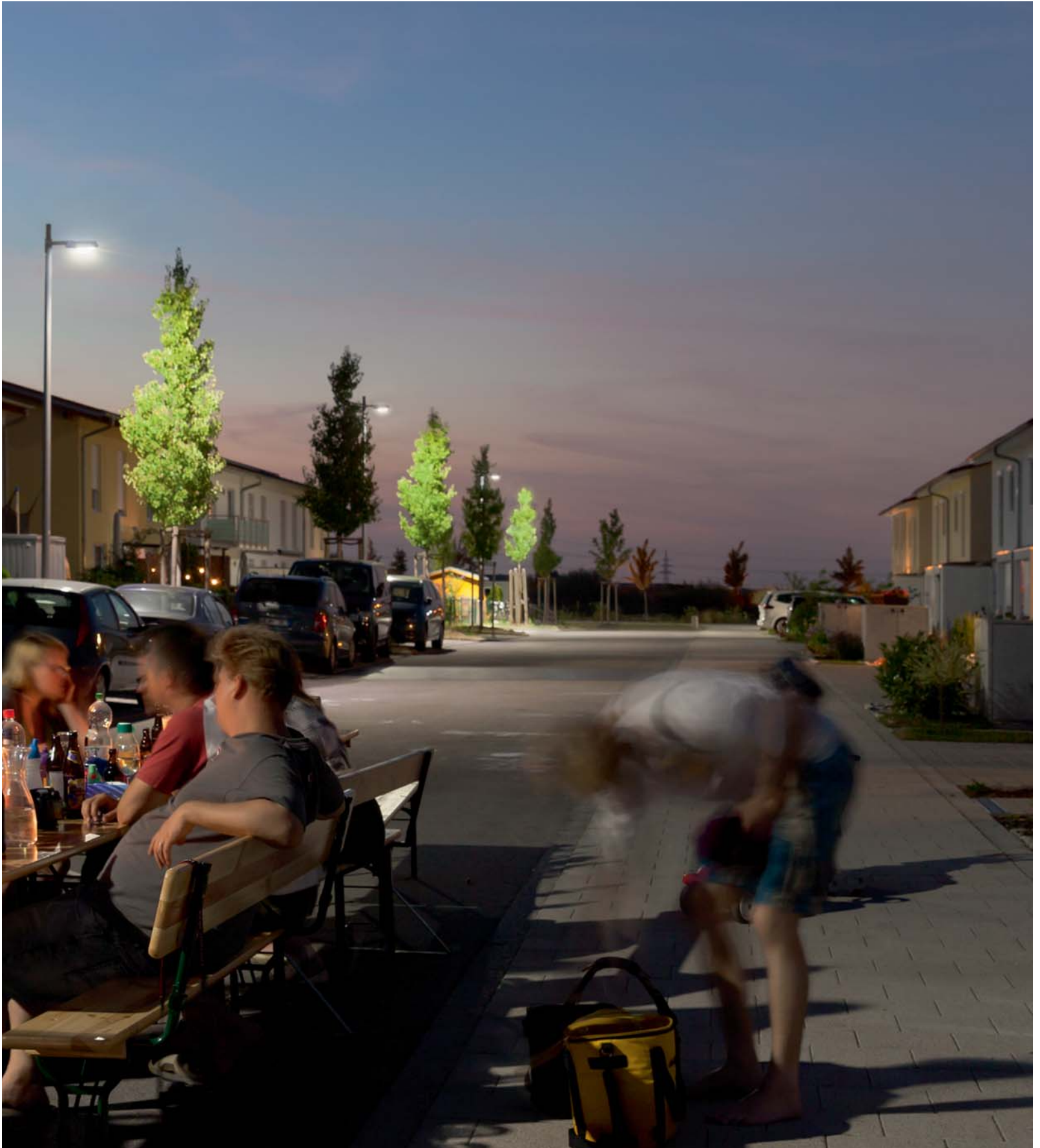

Residential area Zauberwinkel. Poing (D). Planning: Südhausbau München.

OPTICAL ACCESSORIES – RFL500-SE SERIES

A maximum of one internal accessory.



Rearward cut-off shield IL

for [S] version, with side throw distribution.

for RFL530	111-0184
------------	----------

for RFL540	111-0076
------------	----------



Rearward cut-off shield IL

for [A] version, with forward throw distribution.

for RFL530	147-0655
------------	----------

for RFL540	147-0656
------------	----------



Sidewards cut-off shield IL

for [A] version, with forward throw distribution.

for RFL530	111-0075
------------	----------

for RFL540	111-0077
------------	----------

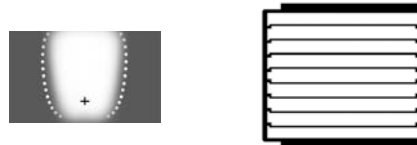



VFL500 SERIES

Post mounted luminaire, side or forward throw distribution, asymmetric and pedestrian/bicycle lane distribution.

IP66. Class I. IK08. Marine-grade, die-cast aluminium alloy. 5CE superior corrosion protection including PCS hardware. Powdercoat finish in RAL 9004, RAL 9006, RAL 9007 or RAL 9016. Silicone CCG® Controlled Compression Gasket. RFC® Reflection Free Contour cover. The luminaire is factory sealed and does not need to be opened during installation.

Integral EC electronic converter.

Factory installed LED circuit board. LED boards can be easily removed for upgrading. PMMA OLC® LED lenses for superior illumination and glare control.

Maximum spacing, for streetlighting applications, depends on wattage and light distribution: 5.5 up to 9 times the mounting height. Recommended mounting height 3.0–6.0 m, depending on wattage selected.

Light source

LED 12-84 W, 4000 K,
for 3000 K refer to www.we-ef.com

Light distributions

[P65] [S60] [S65] [S70] [A60] [R65]

Accessories

- Mounting, page 214
- Eco Step Dim®, page 264
- Surge protection, page 374



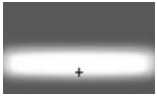

[P65]

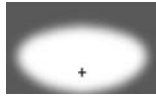

[S60]

[P65] Pedestrian / bicycle lane distribution

[S60] Streetlighting distribution

[P65]	Part ID	Light source	K	lm*	Factor**	kg
VFL520	108-1501	12 LED 12W / 350 mA	4000	1614	0.29	4.7
	108-1503	12 LED 24W / 700 mA	4000	2951	0.50	4.7
VFL530	108-1553	12 LED 12W / 350 mA	4000	1614	0.29	6.4
	108-1557	24 LED 24W / 350 mA	4000	3228	0.58	6.6
	108-1555	12 LED 24W / 700 mA	4000	2951	0.50	6.4
	108-1559	24 LED 48W / 700 mA	4000	5903	1.00	6.6

[S60]	Part ID	Light source	K	lm*	Factor**	kg
VFL520	108-1481	12 LED 12W / 350 mA	4000	1614	0.29	4.7
	108-1483	12 LED 24W / 700 mA	4000	2951	0.50	4.7
VFL530	108-1124	12 LED 12W / 350 mA	4000	1614	0.29	6.4
	108-1154	24 LED 24W / 350 mA	4000	3228	0.58	6.6
	108-1139	12 LED 24W / 700 mA	4000	2951	0.50	6.4
	108-1169	24 LED 48W / 700 mA	4000	5903	1.00	6.6
VFL540	108-0875	24 LED 24W / 350 mA	4000	3228	0.58	7.8
	108-0877	36 LED 36W / 350 mA	4000	4842	0.86	8.2
	108-0879	42 LED 42W / 350 mA	4000	5649	1.00	8.2
	108-0901	24 LED 48W / 700 mA	4000	5903	1.00	7.8
	108-0907	36 LED 72W / 700 mA	4000	8854	1.50	8.2
	108-0913	42 LED 84W / 700 mA	4000	10329	1.75	8.2

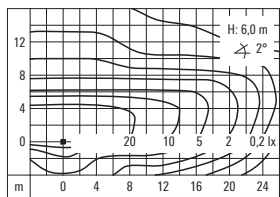

[P65]

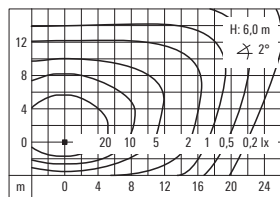

[S60]

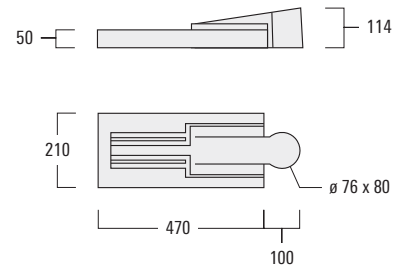

VFL520

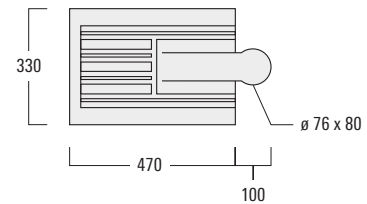

VFL530

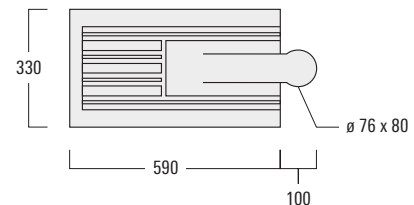

VFL540

Optional ø 60 x 80 version available.
Must be indicated during order placement.

* Nominal lumen output based on LED manufacturers data at 85°C T_J. For rated lumens at 25°C T_q and latest data refer to www.we-ef.com.

** Multiplier for Isolux value

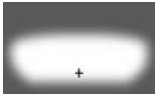

[S65]

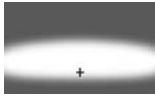

[S70]

[S65] Streetlighting distribution

[S70] Streetlighting distribution

[S65]	Part ID	Light source	K	lm*	Factor**	kg
VFL520	108-1485	12 LED 12W / 350 mA	4000	1614	0.29	4.7
	108-1487	12 LED 24W / 700 mA	4000	2951	0.50	4.7
VFL530	108-1133	12 LED 12W / 350 mA	4000	1614	0.29	6.4
	108-1163	24 LED 24W / 350 mA	4000	3228	0.58	6.6
	108-1148	12 LED 24W / 700 mA	4000	2951	0.50	6.4
	108-1178	24 LED 48W / 700 mA	4000	5903	1.00	6.6
VFL540	108-0967	24 LED 24W / 350 mA	4000	3228	0.58	7.8
	108-0969	36 LED 36W / 350 mA	4000	4842	0.86	8.2
	108-0971	42 LED 42W / 350 mA	4000	5649	1.00	8.2
	108-0968	24 LED 48W / 700 mA	4000	5903	1.00	7.8
	108-0970	36 LED 72W / 700 mA	4000	8854	1.50	8.2
	108-0972	42 LED 84W / 700 mA	4000	10329	1.75	8.2

[S70]	Part ID	Light source	K	lm*	Factor**	kg
VFL520	108-1489	12 LED 12W / 350 mA	4000	1614	0.29	4.7
	108-1491	12 LED 24W / 700 mA	4000	2951	0.50	4.7
VFL530	108-1127	12 LED 12W / 350 mA	4000	1614	0.29	6.4
	108-1157	24 LED 24W / 350 mA	4000	3228	0.58	6.6
	108-1142	12 LED 24W / 700 mA	4000	2951	0.50	6.4
	108-1172	24 LED 48W / 700 mA	4000	5903	1.00	6.6
VFL540	108-0881	24 LED 24W / 350 mA	4000	3228	0.58	7.8
	108-0883	36 LED 36W / 350 mA	4000	4842	0.86	8.2
	108-0885	42 LED 42W / 350 mA	4000	5649	1.00	8.2
	108-0904	24 LED 48W / 700 mA	4000	5903	1.00	7.8
	108-0910	36 LED 72W / 700 mA	4000	8854	1.50	8.2
	108-0916	42 LED 84W / 700 mA	4000	10329	1.75	8.2

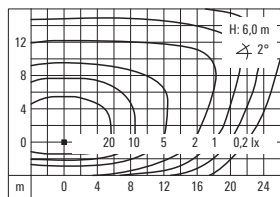

[S65]

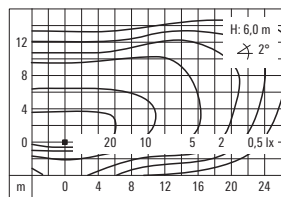

[S70]

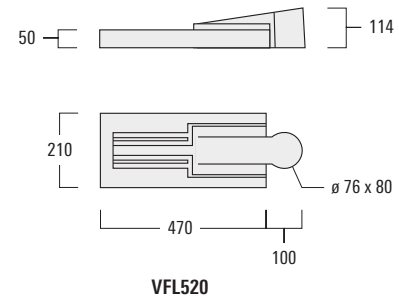

VFL520

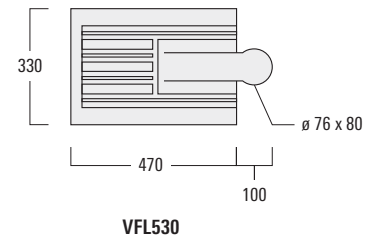

VFL530

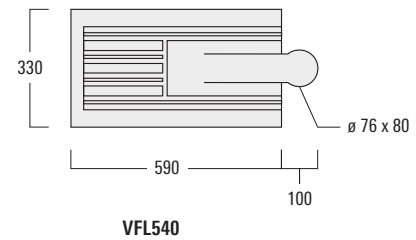

VFL540

Optional ø 60 x 80 version available.
Must be indicated during order placement.

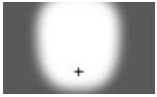

[A60]

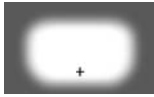

[R65]

[A60] Forward throw distribution, asymmetric

[R65] Rectangular forward throw distribution



[A60]	Part ID	Light source	K	lm*	Factor**	kg
VFL520	108-1497	12 LED 12W / 350 mA	4000	1614	0.29	4.7
	108-1499	12 LED 24W / 700 mA	4000	2951	0.50	4.7
VFL530	108-1130	12 LED 12W / 350 mA	4000	1614	0.29	6.4
	108-1160	24 LED 24W / 350 mA	4000	3228	0.58	6.6
	108-1145	12 LED 24W / 700 mA	4000	2951	0.50	6.4
VFL540	108-1175	24 LED 48W / 700 mA	4000	5903	1.00	6.6
	108-0926	24 LED 24W / 350 mA	4000	3228	0.58	7.8
	108-0929	36 LED 36W / 350 mA	4000	4842	0.86	8.2
	108-0932	42 LED 42W / 350 mA	4000	5649	1.00	8.2
	108-0938	24 LED 48W / 700 mA	4000	5903	1.00	7.8
	108-0941	36 LED 72W / 700 mA	4000	8854	1.50	8.2
	108-0944	42 LED 84W / 700 mA	4000	10329	1.75	8.2

[R65]	Part ID	Light source	K	lm*	Factor**	kg
VFL520	108-1493	12 LED 12W / 350 mA	4000	1614	0.29	4.7
	108-1495	12 LED 24W / 700 mA	4000	2951	0.50	4.7
VFL530	108-1136	12 LED 12W / 350 mA	4000	1614	0.29	6.4
	108-1166	24 LED 24W / 350 mA	4000	3228	0.58	6.6
	108-1151	12 LED 24W / 700 mA	4000	2951	0.50	6.4
VFL540	108-1181	24 LED 48W / 700 mA	4000	5903	1.00	6.6
	108-0973	24 LED 24W / 350 mA	4000	3228	0.58	7.8
	108-0975	36 LED 36W / 350 mA	4000	4842	0.86	8.2
	108-0977	42 LED 42W / 350 mA	4000	5649	1.00	8.2
	108-0974	24 LED 48W / 700 mA	4000	5903	1.00	7.8
	108-0976	36 LED 72W / 700 mA	4000	8854	1.50	8.2
	108-0978	42 LED 84W / 700 mA	4000	10329	1.75	8.2

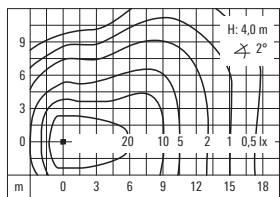

[A60]

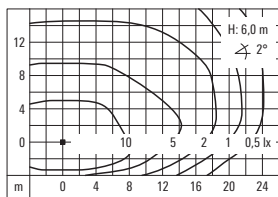

[R65]

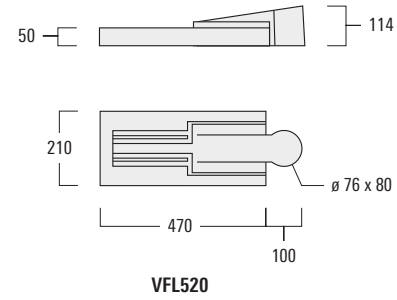

VFL520

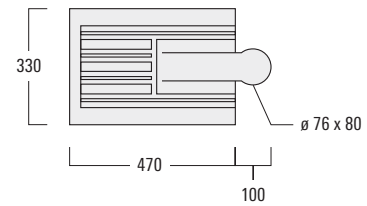

VFL530

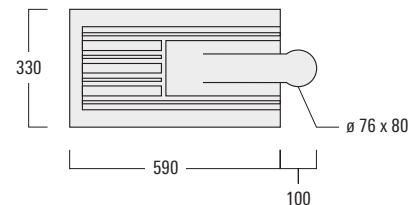

VFL540

Optional ø 60 x 80 version available.
Must be indicated during order placement.

* Nominal lumen output based on LED manufacturers data at 85°C T_j. For rated lumens at 25°C T_a and latest data refer to www.we-ef.com.

** Multiplier for Isolux value

VFL500-SE SERIES

Post mounted luminaire, side or forward throw distribution, asymmetric and pedestrian/bicycle lane distribution.

IP66. Class I. IK08. Marine-grade, die-cast aluminium alloy. 5CE superior corrosion protection including PCS hardware. Powdercoat finish in RAL 9004, RAL 9006, RAL 9007 or RAL 9016. Silicone CCG® Controlled Compression Gasket. RFC® Reflection Free Contour cover. The luminaire is factory sealed and does not need to be opened during installation.

Integral EC electronic converter.

Factory installed LED circuit board. LED boards can be easily removed for upgrading. PMMA OLC® LED lenses for superior illumination and glare control.

Maximum spacing, for streetlighting applications, depends on wattage and light distribution: 5.5 up to 9 times the mounting height. Recommended mounting height 3.0–6.0 m, depending on wattage selected.

Light source

LED 12-96 W, 4000 K,
for 3000 K refer to www.we-ef.com

Light distributions

[P65] [S60] [S65] [S70] [A60] [R65]

Accessories

- Mounting, page 214
- Eco Step Dim®, page 264
- Surge protection, page 374



Main square. Landsberg am Lech (D). Landscape Architect: Lohrer Hochrein Landschaftsarchitekten und Stadtplaner. Lighting design: Day & Light Lichtplanung.

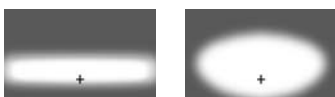

[P65]

[S60]

[P65] Pedestrian / bicycle lane distribution

[S60] Streetlighting distribution



[P65]	Part ID	Light source	K	lm*	Factor**	kg
VFL530-SE	108-1884	12 LED 12W / 350 mA	4000	1614	0.29	5.6
	108-1882	24 LED 24W / 350 mA	4000	3228	0.58	5.8
	108-1880	12 LED 24W / 700 mA	4000	2951	0.50	5.6
	108-1878	24 LED 48W / 700 mA	4000	5903	1.00	5.8

[S60]	Part ID	Light source	K	lm*	Factor**	kg
VFL530-SE	108-1318	12 LED 12W / 350 mA	4000	1614	0.29	5.6
	108-1308	24 LED 24W / 350 mA	4000	3228	0.58	5.8
	108-1298	12 LED 24W / 700 mA	4000	2951	0.50	5.6
	108-1288	24 LED 48W / 700 mA	4000	5903	1.00	5.8
VFL540-SE	108-1268	36 LED 36W / 350 mA	4000	4842	0.86	8.2
	108-1278	48 LED 48W / 350 mA	4000	6456	1.15	8.2
	108-1248	36 LED 72W / 700 mA	4000	8854	1.50	8.2
	108-1258	48 LED 96W / 700 mA	4000	11805	2.00	8.2

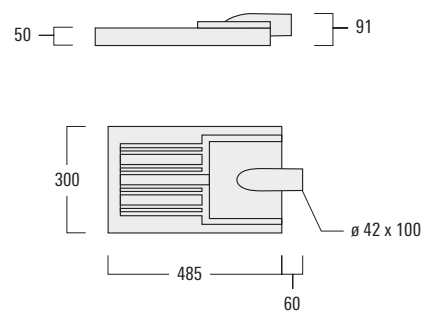

VFL530-SE

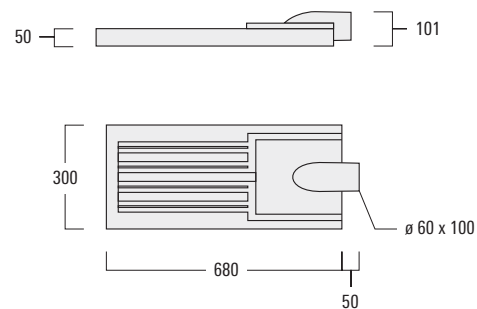

VFL540-SE

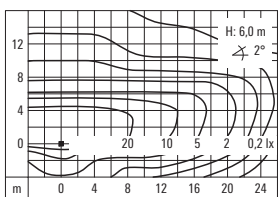

[P65]

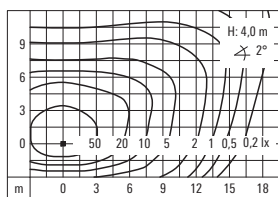

[S60]

* Nominal lumen output based on LED manufacturers data at 85°C T_J. For rated lumens at 25°C T_q and latest data refer to www.we-ef.com.

** Multiplier for Isolux value

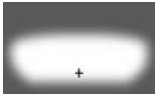

[S65]

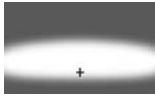

[S70]

[S65] Streetlighting distribution

[S70] Streetlighting distribution

[S65]	Part ID	Light source	K	lm*	Factor**	kg
VFL530-SE	108-1324	12 LED 12W / 350 mA	4000	1614	0.29	5.6
	108-1314	24 LED 24W / 350 mA	4000	3228	0.58	5.8
	108-1304	12 LED 24W / 700 mA	4000	2951	0.50	5.6
	108-1294	24 LED 48W / 700 mA	4000	5903	1.00	5.8
VFL540-SE	108-1274	36 LED 36W / 350 mA	4000	4842	0.86	8.2
	108-1284	48 LED 48W / 350 mA	4000	6456	1.15	8.2
	108-1254	36 LED 72W / 700 mA	4000	8854	1.50	8.2
	108-1264	48 LED 96W / 700 mA	4000	11805	2.00	8.2

[S70]	Part ID	Light source	K	lm*	Factor**	kg
VFL530-SE	108-1320	12 LED 12W / 350 mA	4000	1614	0.29	5.6
	108-1310	24 LED 24W / 350 mA	4000	3228	0.58	5.8
	108-1300	12 LED 24W / 700 mA	4000	2951	0.50	5.6
	108-1290	24 LED 48W / 700 mA	4000	5903	1.00	5.8
VFL540-SE	108-1270	36 LED 36W / 350 mA	4000	4842	0.86	8.2
	108-1280	48 LED 48W / 350 mA	4000	6456	1.15	8.2
	108-1250	36 LED 72W / 700 mA	4000	8854	1.50	8.2
	108-1260	48 LED 96W / 700 mA	4000	11805	2.50	8.2

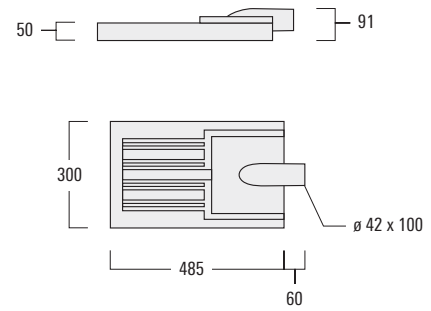

VFL530-SE

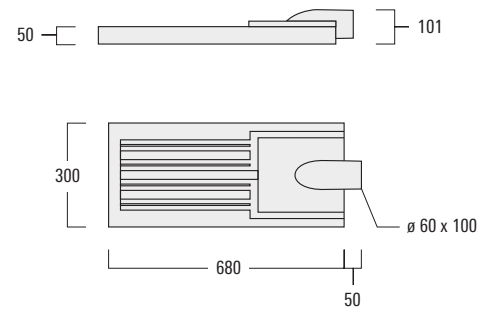

VFL540-SE

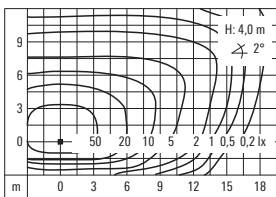

[S65]

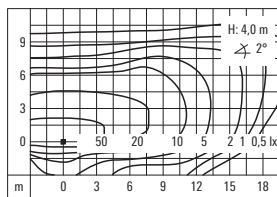

[S70]

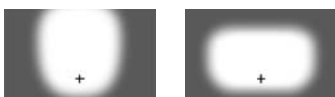

[A60]

[R65]

[A60] Forward throw distribution, asymmetric

[R65] Rectangular forward throw distribution



[A60]	Part ID	Light source	K	lm*	Factor**	kg
VFL530-SE	108-1322	12 LED 12W / 350 mA	4000	1614	0.29	5.6
	108-1312	24 LED 24W / 350 mA	4000	3228	0.58	5.8
	108-1302	12 LED 24W / 700 mA	4000	2951	0.50	5.6
	108-1292	24 LED 48W / 700 mA	4000	5903	1.00	5.8
VFL540-SE	108-1272	36 LED 36W / 350 mA	4000	4842	0.86	8.2
	108-1282	48 LED 48W / 350 mA	4000	6456	1.15	8.2
	108-1252	36 LED 72W / 700 mA	4000	8854	1.50	8.2
	108-1262	48 LED 96W / 700 mA	4000	11805	2.00	8.2

[R65]	Part ID	Light source	K	lm*	Factor**	kg
VFL530-SE	108-1326	12 LED 12W / 350 mA	4000	1614	0.29	5.6
	108-1316	24 LED 24W / 350 mA	4000	3228	0.58	5.8
	108-1306	12 LED 24W / 700 mA	4000	2951	0.50	5.6
	108-1296	24 LED 48W / 700 mA	4000	5903	1.00	5.8
VFL540-SE	108-1276	36 LED 36W / 350 mA	4000	4842	0.86	8.2
	108-1286	48 LED 48W / 350 mA	4000	6456	1.15	8.2
	108-1256	36 LED 72W / 700 mA	4000	8854	1.50	8.2
	108-1266	48 LED 96W / 700 mA	4000	11805	2.00	8.2

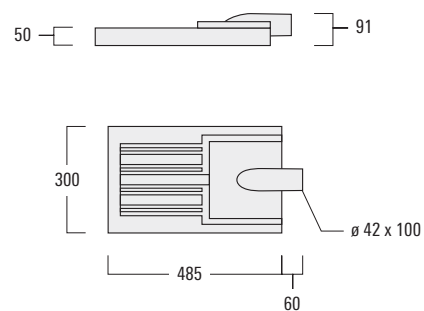

VFL530-SE

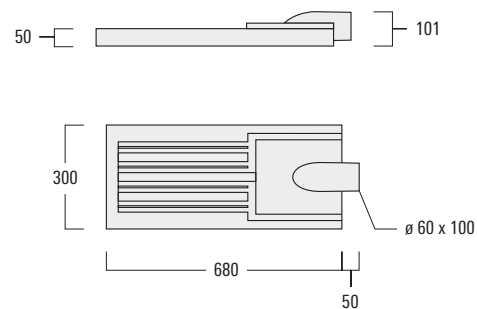

VFL540-SE

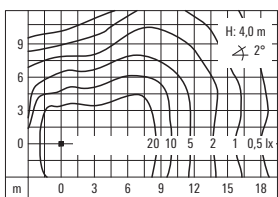

[A60]

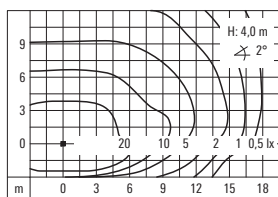

[R65]

* Nominal lumen output based on LED manufacturers data at 85°C T_J. For rated lumens at 25°C T_q and latest data refer to www.we-ef.com.

** Multiplier for Isolux value

MOUNTING ACCESSORIES – VFL500 / VFL500-SE SERIES

Marine-grade aluminium construction. Powdercoat finish in RAL 9004, RAL 9006, RAL 9007 or RAL 9016.

Wall / Pole brackets RV Series				D x L	H / H1	C	kg
for VFL500 Series	108-0979	RV0	Wall bracket	200 / 60	108	2.0	
	108-0980	RV2-76	Pole bracket	∅ 76 x 100	147	4.8	
	108-0981	RV2-60	Pole bracket	∅ 60 x 100	147	4.8	
	108-0982	RV5	Pole bracket		106	1.6	

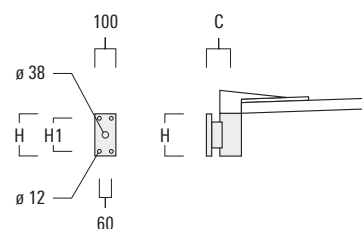

Wall bracket RV0

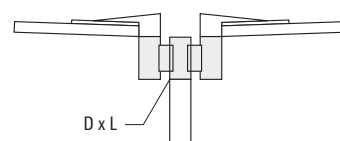

Pole bracket RV2

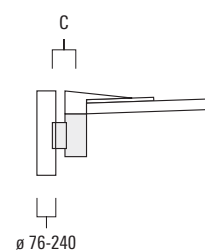

Pole bracket RV5

Wall / Pole brackets RX Series				D x L	H / H1	H	C	kg
for VFL530-SE	111-0053	RX0-530	Wall bracket	350 / 285		710	3.3	
	111-0088	RX1-530	Pole bracket	∅ 76 x 80		400	710	4.5
	111-0089	RX2-530	Pole bracket	∅ 76 x 80		400	710	6.2
for VFL540-SE	111-0086	RX0-540	Wall bracket	450 / 385		1000	5.2	
	111-0054	RX1-540	Pole bracket	∅ 76 x 130		550	1000	6.8
	111-0055	RX2-540	Pole bracket	∅ 76 x 130		550	1000	9.7

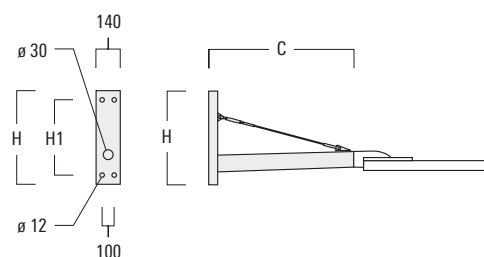

Wall bracket RX0

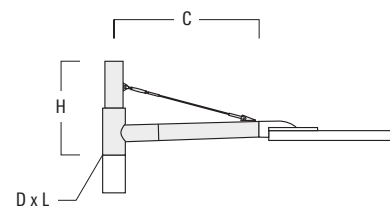

Pole bracket RX1

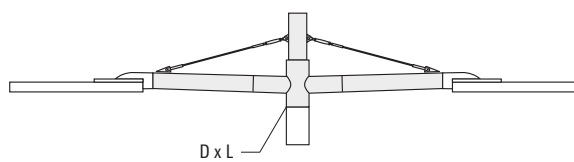

Pole bracket RX2



Main square. Landsberg am Lech (D). Landscape Architect: Lohrer Hochrein Landschaftsarchitekten und Stadtplaner. Lighting design: Day & Light Lichtplanung.

MOUNTING ACCESSORIES – VFL500-SE SERIES

Marine-grade aluminium construction. Powdercoat finish in RAL 9004, RAL 9006, RAL 9007 or RAL 9016.

Wall / Pole brackets RE Series				D x L	D / D1	H	C	kg
for VFL530-SE	111-0052	RE0-530	Wall bracket	230 / 195		180	2.9	
	111-0040	RE1-530	Pole bracket	∅ 76 x 80		400	180	3.2
	111-0041	RE2-530	Pole bracket	∅ 76 x 80		400	180	3.6
for VFL540-SE	111-0084	RE0-540	Wall bracket	230 / 195		180	3.2	
	111-0042	RE1-540	Pole bracket	∅ 76 x 130		550	200	4.6
	111-0043	RE2-540	Pole bracket	∅ 76 x 130		550	200	5.3

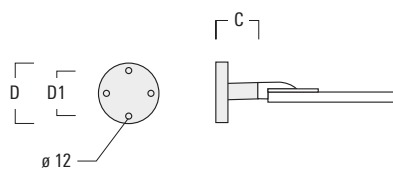

Wall bracket RE0

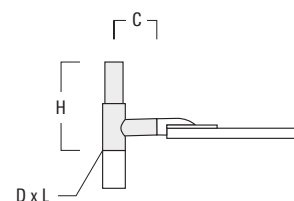

Pole bracket RE1

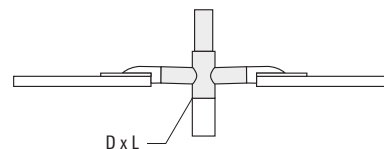

Pole bracket RE2

Pole brackets RF Series				D x L	H	C	kg
for VFL530-SE	111-0044	RF1-530	Pole bracket	∅ 76 x 80	275	190	2.3
	111-0045	RF2-530	Pole bracket	∅ 76 x 80	275	190	3.0
for VFL540-SE	111-0046	RF1-540	Pole bracket	∅ 76 x 80	300	200	2.6
	111-0047	RF2-540	Pole bracket	∅ 76 x 80	300	200	3.3

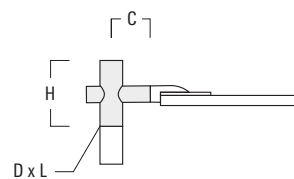

Pole bracket RF1

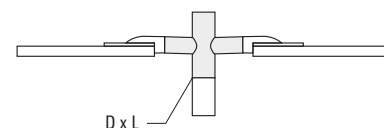

Pole bracket RF2

Wall / Pole brackets RI Series				D x L*	C	kg
for VFL530-SE	111-0178	RI-530	Wall & Pole bracket	∅ 76-108	96	1.5
for VFL540-SE	111-0179	RI-540	Wall & Pole bracket	∅ 76-108	110	1.5

* Pole diameter (structural limitations of pole must be considered)

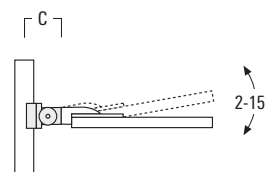

Wall & pole bracket RI

Tilt brackets TB Series				L	D1 / D2	Angle	kg
for VFL530-SE	111-0639	TB-530.42.10	Tilt bracket*	205	∅ 42x90 / ∅ 42x100	7°	0.5
	111-0640	TB-530.42.15	Tilt bracket*	205	∅ 42x90 / ∅ 42x100	13°	0.5
for VFL540-SE	111-0636	TB-540.60.10	Tilt bracket*	205	∅ 60x90 / ∅ 60x100	7°	0.7
	111-0637	TB-540.60.15	Tilt bracket*	205	∅ 60x90 / ∅ 60x100	13°	0.7

* for adjusting luminaire angle

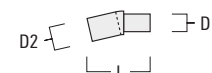

Tilt bracket TB



Main square. Landsberg am Lech (D). Landscape Architect: Lohrer Hochrein Landschaftsarchitekten und Stadtplaner. Lighting design: Day & Light Lichtplanung.

PFL500 SERIES

Post mounted luminaire, side or forward throw distribution, asymmetric.

IP66. Class I. IK08. Marine-grade, die-cast aluminium alloy. 5CE superior corrosion protection including PCS hardware. Powdercoat finish in RAL 9004, RAL 9006, RAL 9007 or RAL 9016. Silicone CCG® Controlled Compression Gasket. RFC® Reflection Free Contour technology. The luminaire is factory sealed and does not need to be opened for installation.

Integral EC electronic converter.

Factory installed LED circuit board. LED boards can be easily removed for upgrading. PMMA OLC® LED lenses for superior illumination and glare control.

Maximum spacing, for streetlighting applications, depends on wattage and light distribution: 5.5 up to 9 times the mounting height. Recommended mounting height 5.0–8.0 m, depending on wattage selected.

Light source

LED 48-144 W, 4000 K,
for 3000 K refer to www.we-ef.com

Light distributions

[S60] [S65] [S70] [A60] [R65]

Accessories

- Mounting, page 222
- Eco Step Dim®, page 264
- Surge protection, page 374



BMW car dealer Riller & Schnack am Hindenburgdamm. Berlin (D). Planning: Uwe Nüßer, Gebäudemanagement Riller & Schnack.

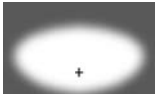

[S60] Streetlighting distribution

[S60]	Part ID	Light source	K	lm*	Factor**	kg
PFL540	108-0949	24 LED 48W / 700 mA	4000	5903	0.55	13.0
	108-0952	24 LED 72W / 1050 mA	4000	10800	1.00	13.0
	108-0950	36 LED 72W / 700 mA	4000	8854	0.82	14.0
	108-0953	36 LED 108W / 1050 mA	4000	16200	1.50	14.0
	108-0951	48 LED 96W / 700 mA	4000	11805	1.03	15.0
	108-0954	48 LED 144W / 1050 mA	4000	21600	2.00	15.0

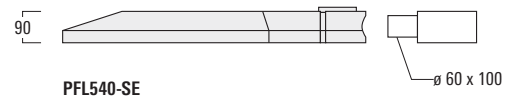
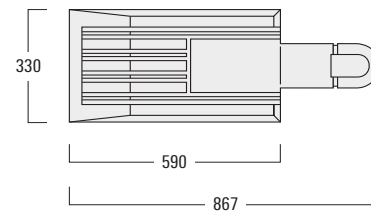
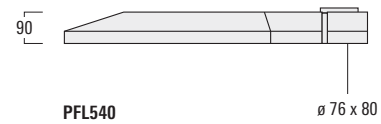

Optional side entry version available.
Must be indicated during order placement.

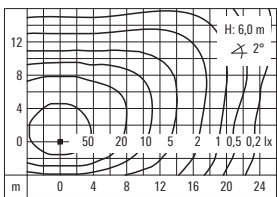

[S60]

* Nominal lumen output based on LED manufacturers data at 85°C T_J. For rated lumens at 25°C T_q and latest data refer to www.we-ef.com.

** Multiplier for Isolux value

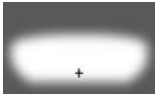

[S65]

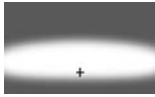

[S70]

[S65] Streetlighting distribution

[S70] Streetlighting distribution

[S65]	Part ID	Light source	K	lm*	Factor**	kg
PFL540	108-0828	24 LED 48W / 700 mA	4000	5903	0.55	13.0
	108-0829	24 LED 72W / 1050 mA	4000	10800	1.00	13.0
	108-0830	36 LED 72W / 700 mA	4000	8854	0.82	14.0
	108-0831	36 LED 108W / 1050 mA	4000	16200	1.50	14.0
	108-0832	48 LED 96W / 700 mA	4000	11085	1.33	15.0
	108-0833	48 LED 144W / 1050 mA	4000	21600	2.00	15.0

[S70]	Part ID	Light source	K	lm*	Factor**	kg
PFL540	108-0824	24 LED 48W / 700 mA	4000	5903	0.55	13.0
	108-0825	24 LED 72W / 1050 mA	4000	10800	1.00	13.0
	108-0823	36 LED 72W / 700 mA	4000	8854	0.82	14.0
	108-0826	36 LED 108W / 1050 mA	4000	16200	1.50	14.0
	108-0822	48 LED 96W / 700 mA	4000	11085	1.03	15.0
	108-0827	48 LED 144W / 1050 mA	4000	21600	2.00	15.0

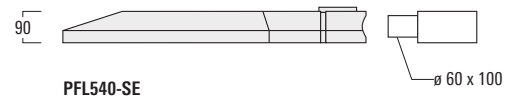
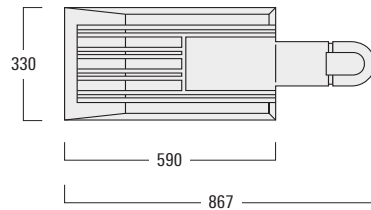
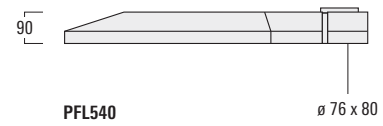

Optional side entry version available.
Must be indicated during order placement.

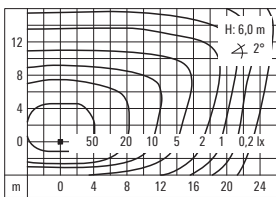

[S65]

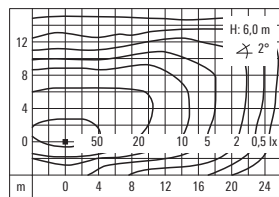

[S70]



[A60]

[R65]

[A60] Forward throw distribution, asymmetric

[R65] Rectangular forward throw distribution



[A60]	Part ID	Light source	K	lm*	Factor**	kg
PFL540	108-0961	24 LED 48W / 700 mA	4000	5903	0.55	13.0
	108-0964	24 LED 72W / 1050 mA	4000	10800	1.00	13.0
	108-0962	36 LED 72W / 700 mA	4000	8854	0.82	14.0
	108-0965	36 LED 108W / 1050 mA	4000	16200	1.50	14.0
	108-0963	48 LED 96W / 700 mA	4000	11085	1.03	15.0
	108-0966	48 LED 144W / 1050 mA	4000	21600	2.00	15.0

[R65]	Part ID	Light source	K	lm*	Factor**	kg
PFL540	108-0955	24 LED 48W / 700 mA	4000	5903	0.55	13.0
	108-0958	24 LED 72W / 700 mA	4000	10800	1.00	13.0
	108-0956	36 LED 72W / 700 mA	4000	8854	0.82	14.0
	108-0959	36 LED 108W / 1050 mA	4000	16200	1.50	14.0
	108-0957	48 LED 96W / 700 mA	4000	11085	1.03	15.0
	108-0960	48 LED 144W / 1050 mA	4000	21600	2.00	15.0

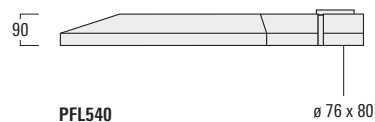

PFL540

ø 76 x 80

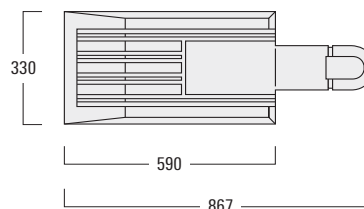

PFL540-SE

ø 60 x 100

Optional side entry version available.
Must be indicated during order placement.

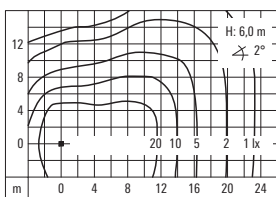

[A60]

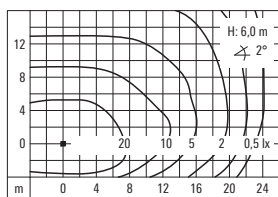

[R65]

* Nominal lumen output based on LED manufacturers data at 85°C T_J. For rated lumens at 25°C T_q and latest data refer to www.we-ef.com.

** Multiplier for Isolux value

MOUNTING ACCESSORIES – PFL500 SERIES

Marine-grade aluminium construction. Powdercoat finish in RAL 9004, RAL 9006, RAL 9007 or RAL 9016.

Wall / Pole bracket RV Series				D x L	H / H1	C	kg
for PFL540	108-0979	RV0	Wall bracket	200 / 160		108	2.0
	108-0980	RV2-76	Pole bracket	∅ 76 x 100		147	4.8
	108-0981	RV2-60	Pole bracket	∅ 60 x 100		147	4.8
	108-0982	RV5	Pole bracket			108	1.7

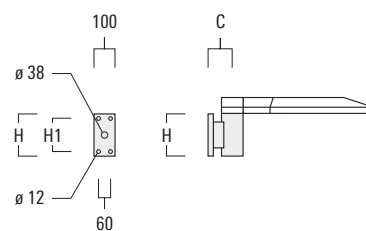

Wall bracket RV0

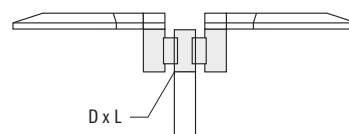

Pole bracket RV2

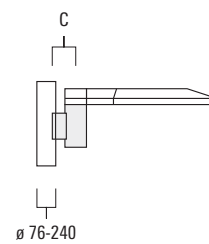

Pole bracket RV5



PFL200 SERIES

Post mounted luminaire, side or forward throw distribution, asymmetric and pedestrian/bicycle lane distribution.

IP66, Class I. IK08. Marine-grade die-cast aluminium alloy. 5CE superior corrosion protection including PCS hardware. Powdercoat finish in RAL 9004, RAL 9006, RAL 9007 or RAL 9016. Silicone rubber gaskets. Safety glass lens, hinged.

Integral EC electronic converter.

Factory installed LED circuit board. LED boards can be easily removed for upgrading. PMMA OLC® LED lenses for superior illumination and glare control.

Recommended mounting height 2.5–6.0 m, depending on wattage selected.

Mounting brackets to be ordered separately.

Light source

LED 12-72 W, 4000 K,
for 3000 K refer to www.we-ef.com

Light distributions

[P65] [S65] [A60] [R65]

Accessories

- Mounting, page 232
- Eco Step Dim®, page 264
- Surge protection, page 374



Carpark, South Leicestershire College, Leicester (UK). Architects: Metz Architects Ltd.

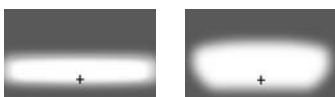

[P65]

[S65]

[P65] Pedestrian / bicycle lane distribution

[S65] Streetlighting distribution



[P65]	Part ID	Light source	K	lm*	Factor**	kg
PFL230	108-1780	12 LED 12W / 350 mA	4000	1614	0.55	10.0
	108-1788	18 LED 18W / 350 mA	4000	2421	0.82	10.0
	108-1630	12 LED 24W / 700 mA	4000	2951	1.00	10.0
	108-1730	18 LED 36W / 700 mA	4000	4427	1.50	10.0

[S65]	Part ID	Light source	K	lm*	Factor**	kg
PFL230	108-1774	12 LED 12W / 350 mA	4000	1614	0.55	10.0
	108-1782	18 LED 18W / 350 mA	4000	2421	0.82	10.0
	108-1632	12 LED 24W / 700 mA	4000	2951	1.00	10.0
	108-1724	18 LED 36W / 700 mA	4000	4427	1.50	10.0
PFL240	108-1700	18 LED 36W / 700 mA	4000	4427	1.50	13.5
	108-1678	24 LED 48W / 700 mA	4000	5903	2.00	13.5
	108-1688	18 LED 54W / 1050 mA	4000	8100	2.75	13.5
	108-1641	24 LED 72W / 1050 mA	4000	10800	3.66	13.5

PFL230

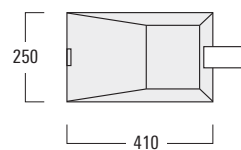
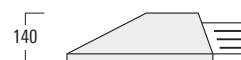

PFL240

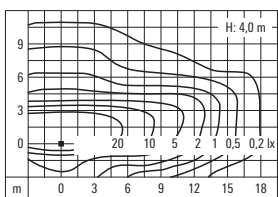
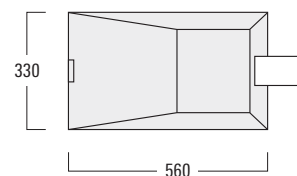

[P65]

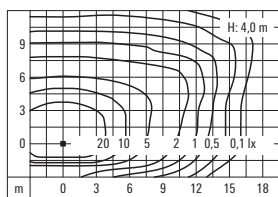

[S65]

* Nominal lumen output based on LED manufacturers data at 85°C T_J. For rated lumens at 25°C T_q and latest data refer to www.we-ef.com.

** Multiplier for Isolux value



[A60] Forward throw distribution, asymmetric

[A60]	Part ID	Light source	K	lm*	Factor**	kg
PFL230	108-1778	12 LED 12W / 350 mA	4000	1614	0.55	10.0
	108-1786	18 LED 18W / 350 mA	4000	2421	0.82	10.0
	108-1629	12 LED 24W / 700 mA	4000	2951	1.00	10.0
	108-1728	18 LED 36W / 700 mA	4000	4427	1.50	10.0
PFL240	108-1704	18 LED 36W / 700 mA	4000	4427	1.50	13.5
	108-1682	24 LED 48W / 700 mA	4000	5903	2.00	13.5
	108-1692	18 LED 54W / 1050 mA	4000	8100	2.75	13.5
	108-1643	24 LED 72W / 1050 mA	4000	10800	3.66	13.5

PFL230

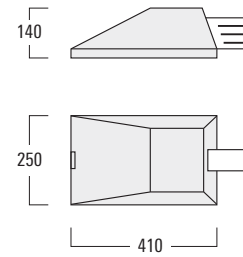

PFL240

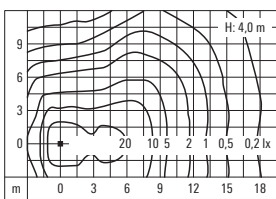
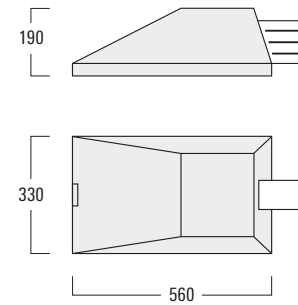

[A60]

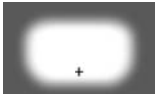

[R65] Rectangular forward throw distribution



[R65]	Part ID	Light source	K	lm*	Factor**	kg
PFL230	108-1776	12 LED 12W / 350 mA	4000	1614	0.55	10.0
	108-1784	18 LED 18W / 350 mA	4000	2421	0.82	10.0
	108-1623	12 LED 24W / 700 mA	4000	2951	1.00	10.0
PFL240	108-1726	18 LED 36W / 700 mA	4000	4427	1.50	10.0
	108-1702	18 LED 36W / 700 mA	4000	4427	1.50	13.5
	108-1680	24 LED 48W / 700 mA	4000	5903	2.00	13.5
	108-1690	18 LED 54W / 1050 mA	4000	8100	2.75	13.5
	108-1639	24 LED 72W / 1050 mA	4000	10800	3.66	13.5

PFL230

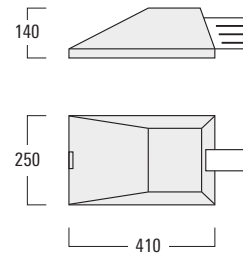

PFL240

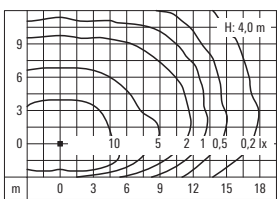
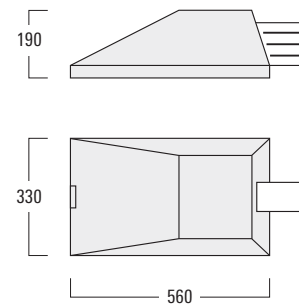

[R65]

* Nominal lumen output based on LED manufacturers data at 85°C T_J. For rated lumens at 25°C T_q and latest data refer to www.we-ef.com.

** Multiplier for Isolux value

PFL200 SERIES

Post mounted luminaire, side or forward throw distribution, asymmetric.

IP66, Class I. IK08. Marine-grade die-cast aluminium alloy. 5CE superior corrosion protection including PCS hardware. Powdercoat finish in RAL 9004, RAL 9006, RAL 9007 or RAL 9016. Silicone rubber gaskets. Safety glass lens, hinged.

Integral HPF or ECG control gear. Anodised aluminium reflector, for beam efficiency and glare control.

Recommended mounting height 2.5–9.0 m, depending on wattage selected.

Mounting brackets to be ordered separately.

Light source
HIT 20-400 W

Light distributions
[S60] [A60]

Accessories

■ Mounting, page 232

■ Optical, page 240



Main station. Essen (D)

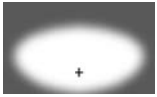

[S60]

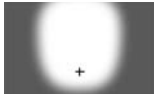

[A60]

[S60] Side throw distribution, asymmetric

[A60] Forward throw distribution, asymmetric



[S60]	Part ID	Light source	lm	Factor*	kg
PFL230	108-0749 [ECG]	HIT-CE 20W G12	1650	0.46	5.8
	108-0422 [ECG]	HIT-CE 35W G12	3600	1.00	7.1
	108-0423 [ECG]	HIT-CE 70W G12	7300	2.03	7.1

[A60]	Part ID	Light source	lm	Factor*	kg
PFL230	108-0752 [ECG]	HIT-CE 20W G12	1650	0.46	5.8
	108-0425 [ECG]	HIT-CE 35W G12	3600	1.00	7.1
	108-0426 [ECG]	HIT-CE 70W G12	7300	2.03	7.1

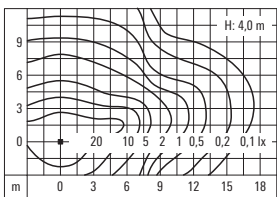
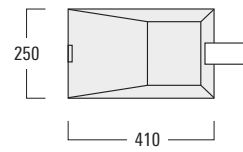

[S60]

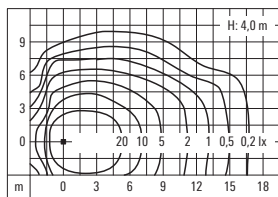

[A60]

* Multiplier for Isolux value

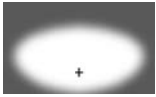

[S60]

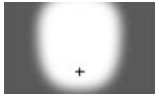

[A60]

[S60] Side throw distribution, asymmetric

[A60] Forward throw distribution, asymmetric

[S60]	Part ID	Light source	lm	Factor*	kg
PFL240	108-0540 [ECG]	HIT-COS 60W PGZ12	6850	0.98	9.4
	108-0543 [ECG]	HIT-COS 90W PGZ12	10450	1.49	9.6
	108-0745 [ECG]	HIT-COS 140W PGZ12	16500	2.36	10.0
	108-0196 [ECG]	HIT-CE 70W E27	7000	1.00	8.1
	108-0016 [ECG]	HIT-CE 150W E40	14500	2.07	9.3

[A60]	Part ID	Light source	lm	Factor*	kg
PFL240	108-0647 [ECG]	HIT-COS 60W PGZ12	6850	0.98	9.4
	108-0705 [ECG]	HIT-COS 90W PGZ12	10450	1.49	9.6
	108-0746 [ECG]	HIT-COS 140W PGZ12	16500	2.36	10.0
	108-0194 [ECG]	HIT-DE-CE 70W RX7s	6800	1.00	8.1
	108-0131 [ECG]	HIT-DE-CE 150W RX7s	14500	2.07	9.3

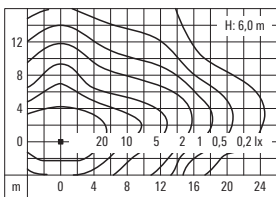
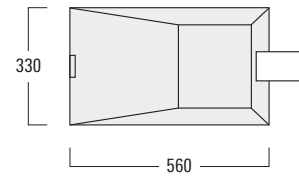

[S60]

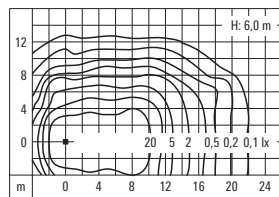

[A60]

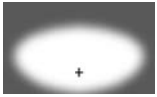

[S60]

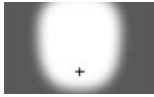

[A60]

[S60] Side throw distribution, asymmetric

[A60] Forward throw distribution, asymmetric



[S60]	Part ID	Light source	lm	Factor*	kg
PFL260	108-0541 [ECG]	HIT-COS 140W PGZ12	16500	0.64	14.1
	108-0024 [HPF]	HIT-CE 250W E40	26000	1.00	16.0
	108-0026 [HPF]	HIT 400W E40	35000	1.35	17.6

[A60]	Part ID	Light source	lm	Factor*	kg
PFL260	108-0648 [ECG]	HIT-COS 140W PGZ12	16500	0.64	14.1
	108-0048 [HPF]	HIT-DE 250W Fc2	20000	1.00	16.0
	108-0050 [HPF]	HIT-DE 400W Fc2	36000	1.35	17.6

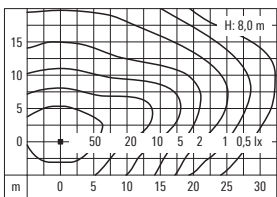
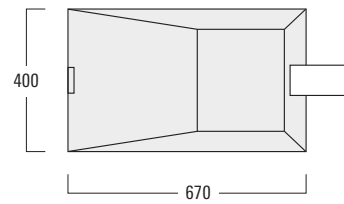
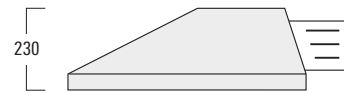

[S60]

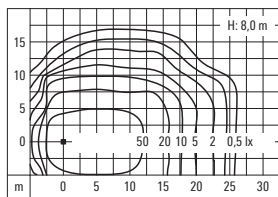

[A60]

* Multiplier for Isolux value

MOUNTING ACCESSORIES – PFL200 SERIES

Marine-grade aluminium construction. Powdercoat finish in RAL 9004, RAL 9006, RAL 9007 or RAL 9016.

Wall / Pole brackets KP Series				D / D1	H	C	kg
for PFL230	108-0433	KP0-230	Wall bracket	180 / 140		195	1.5
	108-0434	KP1-230	Pole bracket		525	210	3.6
	108-0435	KP2-230	Pole bracket		525	210	4.3
for PFL240	108-0103	KP0-240	Wall bracket	230 / 195		200	2.0
	108-0104	KP1-240	Pole bracket		575	215	3.8
	108-0105	KP2-240	Pole bracket		575	215	4.7
for PFL260	108-0056	KP0-260	Wall bracket	275 / 235		230	2.6
	108-0044	KP1-260	Pole bracket		675	250	4.3
	108-0045	KP2-260	Pole bracket		675	250	5.5

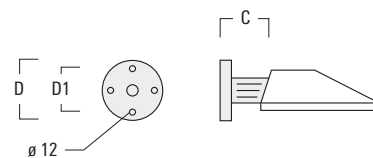

Wall bracket KP0

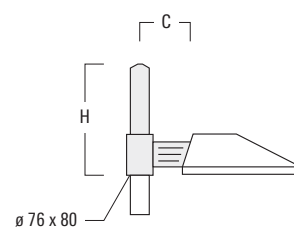

Pole bracket KP1

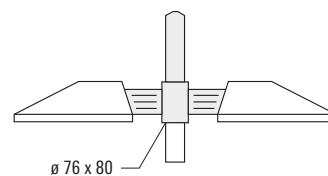

Pole bracket KP2

Pole brackets KP-L Series				H	C	kg
for PFL230	108-0713	KP1-L-230	Pole bracket	525	450	6.3
	108-0714	KP2-L-230	Pole bracket	525	450	9.5
for PFL240	108-0268	KP1-L-240	Pole bracket	575	635	9.1
	108-0373	KP2-L-240	Pole bracket	575	635	15.0
for PFL260	108-0281	KP1-L-260	Pole bracket	675	635	10.4
	108-0280	KP2-L-260	Pole bracket	675	635	17.5

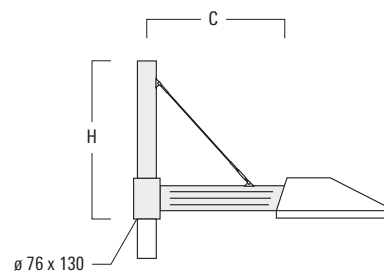

Pole bracket KP1-L

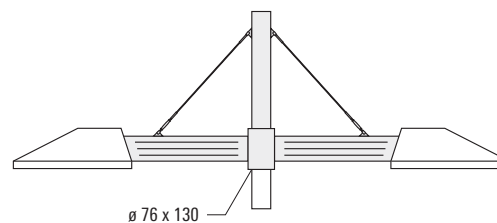

Pole bracket KP2-L

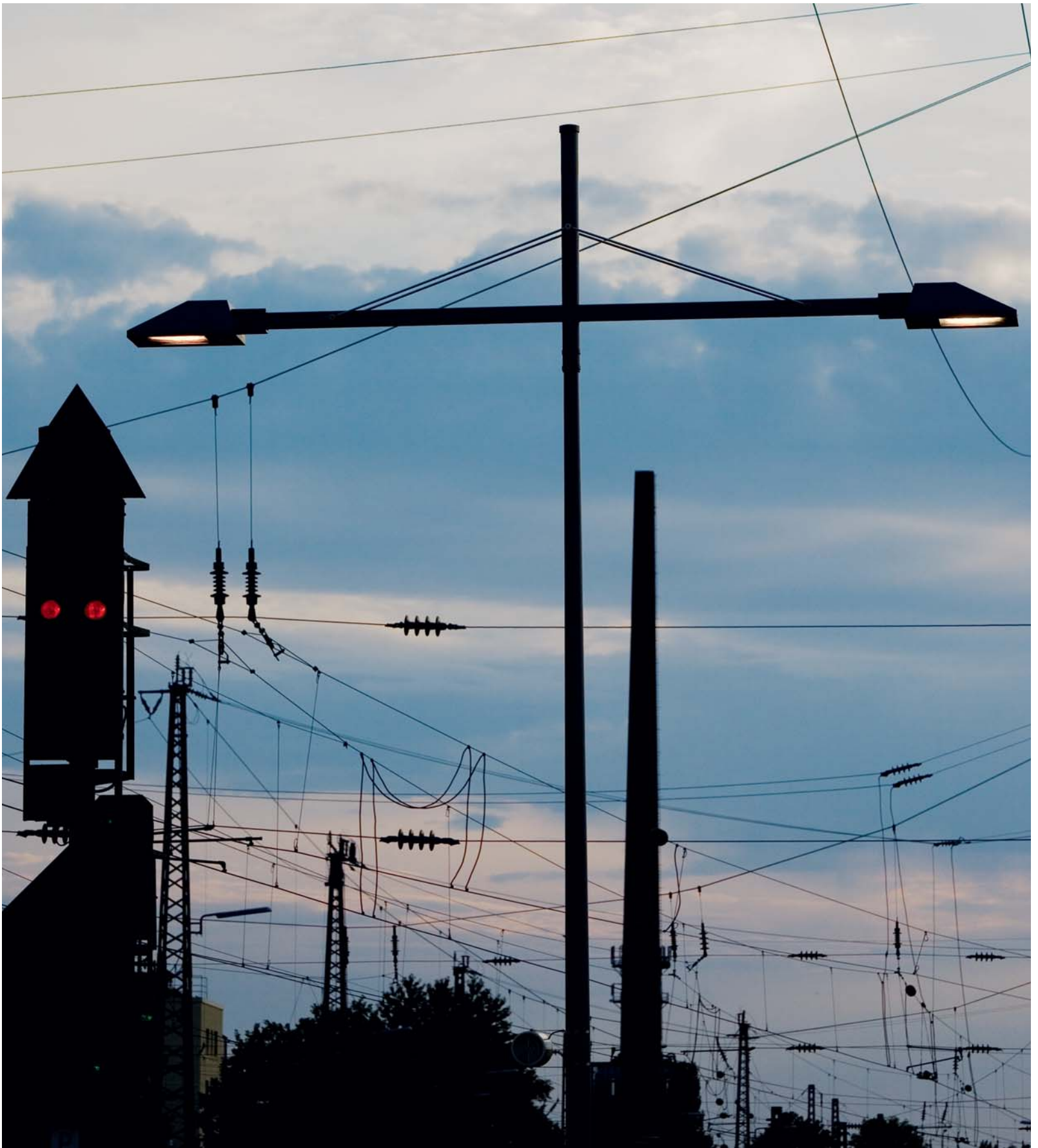

Main station. Essen (D)

MOUNTING ACCESSORIES – PFL200 SERIES

Marine-grade aluminium construction. Powdercoat finish in RAL 9004, RAL 9006, RAL 9007 or RAL 9016.

Pole brackets KI Series

				D / D1	H	C	kg
for PFL230	108-0430	KI0-230	Wall bracket	180 / 148		210	3.0
	108-0431	KI1-230	Pole bracket		475	210	4.3
	108-0432	KI2-230	Pole bracket		475	210	6.0

Incrementless vertical aiming $\pm 30^\circ$

for PFL240	108-0493	KI0-240	Wall bracket	180 / 140		210	5.7
	108-0491	KI1-240	Pole bracket		525	210	6.9
	108-0492	KI2-240	Pole bracket		525	210	8.6

Incrementless vertical aiming $\pm 30^\circ$

for PFL260	108-0493	KI0-260	Wall bracket	180 / 140		210	5.7
	108-0494	KI1-260	Pole bracket		575	210	8.5
	108-0495	KI2-260	Pole bracket		575	210	10.3

Incrementless vertical aiming $\pm 30^\circ$

Pole brackets KY Series

				H	C	kg
for PFL230	108-0496	KY1-230	Pole bracket	730	210	8.2
	108-0497	KY2-230	Pole bracket	730	210	9.4

Incrementless vertical aiming $\pm 30^\circ$

for PFL240	108-0500	KY1-240	Pole bracket	930	210	9.9
	108-0501	KY2-240	Pole bracket	930	210	12.8

Incrementless vertical aiming $\pm 30^\circ$

for PFL260	108-0500	KY1-260	Pole bracket	930	210	11.7
	108-0501	KY2-260	Pole bracket	930	210	14.6

Incrementless vertical aiming $\pm 30^\circ$

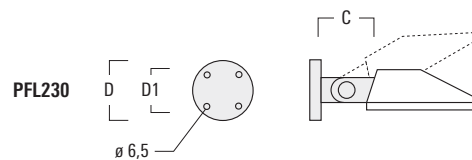

PFL230

Wall bracket KI0

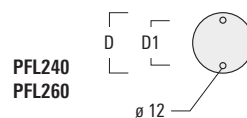

PFL240
PFL260

Pole bracket KI1

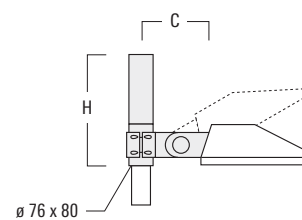

Pole bracket KI2

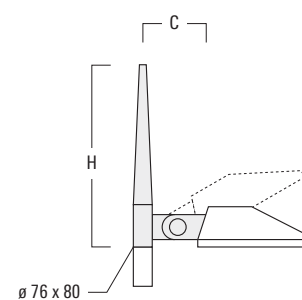
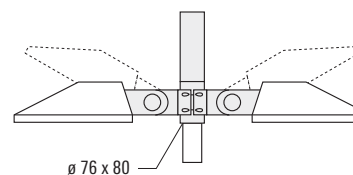

Pole bracket KY1

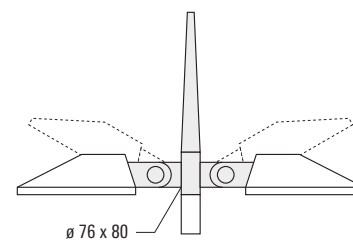

Pole bracket KY2



Theresienhöhe MK2. München (D). Lighting design: Ingenieurgruppe München.

MOUNTING ACCESSORIES – PFL200 SERIES

Marine-grade aluminium construction. Powdercoat finish in RAL 9004, RAL 9006, RAL 9007 or RAL 9016.

Pole brackets KL Series				H	C	kg
for PFL240	108-0342	KL1-240	Pole bracket	750	735	9.0
	108-0532	KL2-240	Pole bracket	750	735	14.0
for PFL260	108-0380	KL1-260	Pole bracket	1100	1135	14.0
	108-0299	KL2-260	Pole bracket	1100	1135	21.0

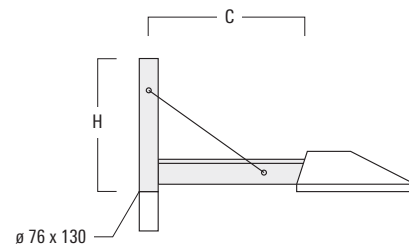

Pole bracket KL1

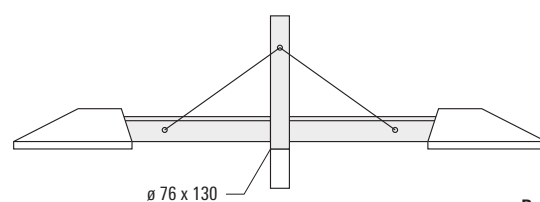

Pole bracket KL2

Pole brackets KX Series				H	C	kg
for PFL240	108-0343	KX1-240	Pole bracket	410	735	7.0
	108-0534	KX2-240	Pole bracket	410	735	11.0
for PFL260	108-0533	KX1-260	Pole bracket	630	1135	11.0
	108-0473	KX2-260	Pole bracket	630	1135	17.0

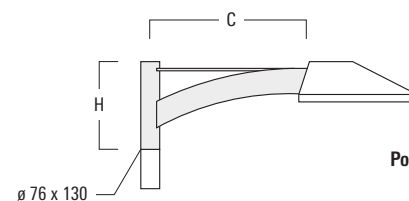

Pole bracket KX1

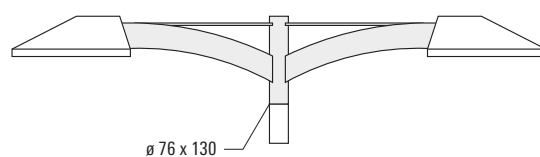

Pole bracket KX2



ZAC Champolion. Dijon (F). Lighting design: Vittorio Sparta, Eclar, Chagny.

MOUNTING ACCESSORIES – PFL200 SERIES

Marine-grade aluminium construction. Powdercoat finish in RAL 9004, RAL 9006, RAL 9007 or RAL 9016.

Pole clamps SK Series				D*	C	kg
for PFL230	108-0474	SK1-230	Pole clamp	ø 76-89	175	2.1
	108-0475	SK1-230	Pole clamp	ø 102-114	175	2.4
	108-0476	SK2-230	Pole clamp	ø 76-89	175	2.9
	108-0477	SK2-230	Pole clamp	ø 102-114	175	3.2
for PFL240	108-0788	SK1-240	Pole clamp	ø 76-89	175	3.0
	108-0782	SK1-240	Pole clamp	ø 102-114	175	3.4
	108-0789	SK1-240	Pole clamp	ø 114-133	175	3.8
	108-0790	SK2-240	Pole clamp	ø 76-89	175	3.9
	108-0784	SK2-240	Pole clamp	ø 102-114	175	4.3
	108-0791	SK2-240	Pole clamp	ø 114-133	175	4.7
for PFL260	108-0792	SK1-260	Pole clamp	ø 76-89	210	3.6
	108-0793	SK1-260	Pole clamp	ø 102-114	175	4.0
	108-0794	SK1-260	Pole clamp	ø 114-133	210	4.4
	108-0795	SK2-260	Pole clamp	ø 76-89	210	4.8
	108-0796	SK2-260	Pole clamp	ø 102-114	175	5.2
	108-0797	SK2-260	Pole clamp	ø 114-133	210	5.6

* Pole diameter (structural limitations of pole must be considered)

Pole clamps SI Series				D*	C	kg
for PFL230	108-0478	SI1-230	Pole clamp	ø 76-89	210	2.9
	108-0479	SI1-230	Pole clamp	ø 102-114	210	3.1
	108-0480	SI2-230	Pole clamp	ø 76-89	210	4.5
	108-0481	SI2-230	Pole clamp	ø 102-114	210	4.7

Incrementless vertical aiming ± 30°

for PFL240	108-0482	SI1-240	Pole clamp	ø 76-89	210	3.6
	108-0781	SI1-240	Pole clamp	ø 102-114	210	4.0
	108-0483	SI1-240	Pole clamp	ø 114-133	210	4.4
	108-0484	SI2-240	Pole clamp	ø 76-89	210	5.2
	108-0783	SI2-240	Pole clamp	ø 102-114	210	5.7
	108-0485	SI2-240	Pole clamp	ø 114-133	210	6.2

Incrementless vertical aiming ± 30°

for PFL260	108-0482	SI1-260	Pole clamp	ø 76-89	210	3.6
	108-0781	SI1-260	Pole clamp	ø 102-114	210	4.0
	108-0483	SI1-260	Pole clamp	ø 114-133	210	4.4
	108-0484	SI2-260	Pole clamp	ø 76-89	210	5.2
	108-0783	SI2-260	Pole clamp	ø 102-114	210	5.7
	108-0485	SI2-260	Pole clamp	ø 114-133	210	6.2

Incrementless vertical aiming ± 30°

* Pole diameter (structural limitations of pole must be considered)

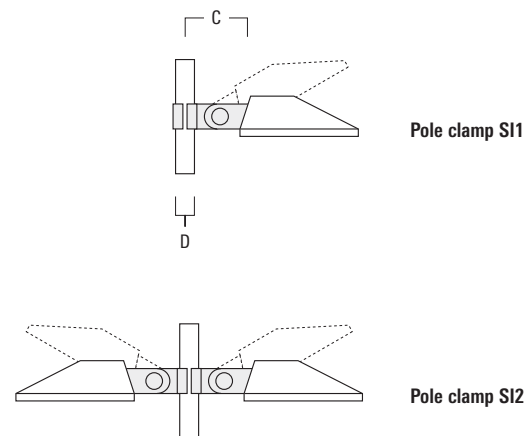
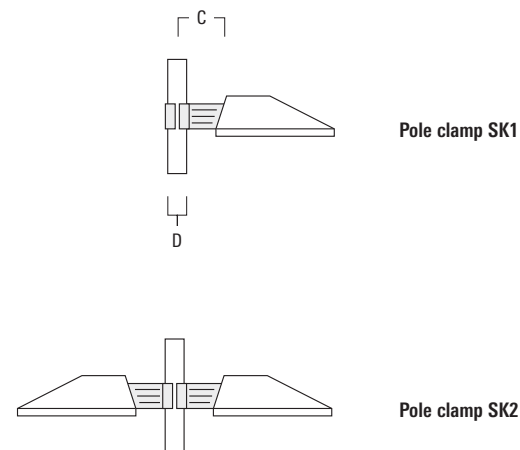



Temple Quay, Bristol (UK). Architect: Landscape Projects.

OPTICAL ACCESSORIES – PFL200 SERIES

A maximum of one internal optical accessory.



Rearward cut-off shield IL

for [S] version, with side throw distribution

for PFL230 108-0427

for PFL240 108-0469

for PFL260 108-0040

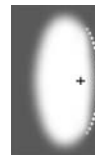

Rearward cut-off shield IL

for [A] version, with forward throw distribution

for PFL230 147-0655

for PFL240 147-0656

for PFL260 147-0410



Sideways cut-off shield IL

for [A] version, with forward throw distribution

for PFL230 108-0428

for PFL240 108-0470

for PFL260 108-0041

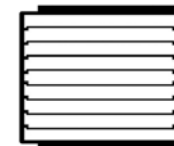



EFL500 SERIES

Post mounted luminaire, side or forward throw distribution, asymmetric.

IP66. Class I. IK08. Marine-grade die-cast aluminium alloy. 5CE superior corrosion protection including PCS hardware. Powdercoat finish in RAL 9004, RAL 9006, RAL 9007 or RAL 9016. Silicone CCG® Controlled Compression Gasket. Safety glass lens.

Integral EC electronic converter.

Factory installed LED circuit board. LED boards can be easily removed for upgrading. PMMA OLC® LED lenses for superior illumination and glare control.

Recommended mounting height 4.5–6.0 m, depending on wattage selected.

Combination post and side entry. Mounting brackets to be ordered separately.

Light source

LED 36-54 W, 4000 K,
for 3000 K refer to www.we-ef.com

Light distributions

[S65] [R65]

Accessories

- Mounting, page 244
- Eco Step Dim®, page 264
- Surge protection, page 374



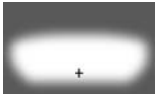

[S65]

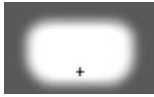

[R65]

[S65] Streetlighting distribution

[R65] Rectangular forward throw distribution



[S65]	Part ID	Light source	K	lm*	Factor**	kg
EFL540	107-0080	18 LED 36W / 700 mA	4000	4427	1.00	9.9
	107-0085	18 LED 54W / 1050 mA	4000	8100	1.83	9.9

[R65]	Part ID	Light source	K	lm*	Factor**	kg
EFL540	107-0082	18 LED 36W / 700 mA	4000	4427	1.00	9.9
	107-0087	18 LED 54W / 1050 mA	4000	8100	1.83	9.9

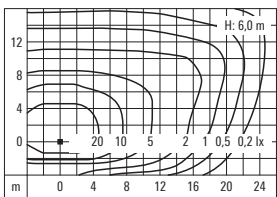
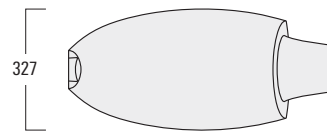
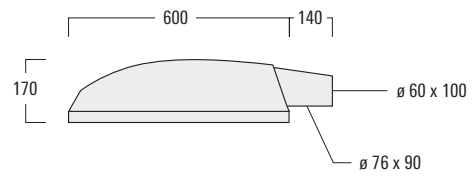

[S65]

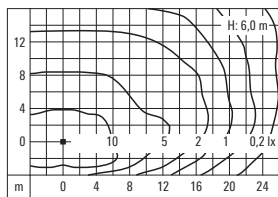

[R65]

* Nominal lumen output based on LED manufacturers data at 85°C T_J. For rated lumens at 25°C T_q and latest data refer to www.we-ef.com.

** Multiplier for Isolux value

MOUNTING ACCESSORIES – EFL500 SERIES

Marine-grade aluminium construction. Powdercoat finish in RAL 9004, RAL 9006, RAL 9007 or RAL 9016.

Wall / Pole brackets RE Series				D / D1	H	C	kg
for EFL540	111-0084	RE0-540	Wall bracket	230 / 195		180	3.2
	111-0042	RE1-540	Pole bracket		550	200	4.6
	111-0043	RE2-540	Pole bracket		550	200	5.3

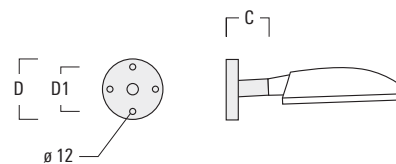

Wall bracket RE0

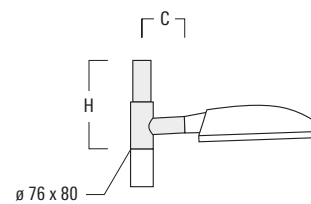

Pole bracket RE1

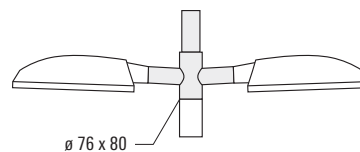

Pole bracket RE2

Wall / Pole brackets RV Series				D x L	H / H1	C	kg
for EFL540	108-0979	RV0	Wall bracket	200 / 160		108	2.0
	108-0981	RV2-60	Pole bracket	ø 60 x 100		147	4.8
	108-0980	RV2-76	Pole bracket	ø 76 x 100		147	4.8
	108-0982	RV5	Pole bracket			106	1.6

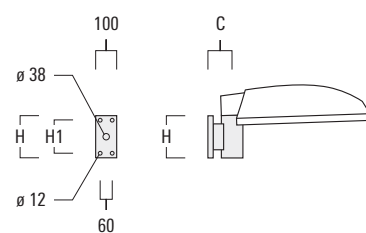

Wall bracket RV0

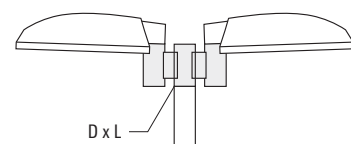

Pole bracket RV2

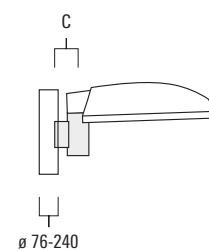

Pole bracket RV5



AL500 SERIES

Post mounted luminaire, controlled distribution, symmetric.

IP55, Class I. IK10. Marine-grade die-cast aluminium alloy. 5CE superior corrosion protection including PCS hardware. Powdercoat finish in RAL 9004, RAL 9006, RAL 9007 or RAL 9016. Silicone rubber gaskets. Polycarbonate main lens.

Integral EC electronic converter.

Factory installed LED circuit board. LED boards can be easily removed for upgrading. PMMA double lens.

Recommended mounting height 3.0–4.5 m, depending on wattage selected.

Light source

LED 17-24 W, 4000 K,
for 3000 K refer to www.we-ef.com

Light distribution

[C60]

Accessories

- Eco Step Dim®, page 264
- Surge protection, page 374





[C60] Controlled distribution, symmetric



[C60]	Part ID	Light source	K	lm*	Factor**	kg
AL534	127-1257	LED-FT 17W	4000	2915	1.00	6.1
	127-1259	LED-FT 24W	4000	2940	1.35	6.1

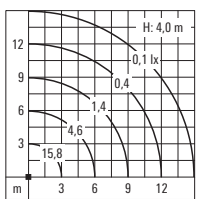
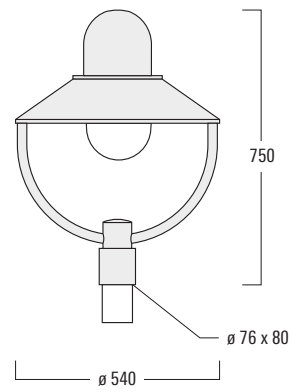

[C60]

* Nominal lumen output based on LED manufacturers data at 25°C T_c. For rated lumens at 25°C T_q and latest data refer to www.we-ef.com.

** Multiplier for Isolux value

ALP500 SERIES

Pendant luminaire, controlled distribution, symmetric.

IP55, Class I, IK10. Marine-grade die-cast aluminium alloy. 5CE superior corrosion protection including PCS hardware. Powdercoat finish in RAL 9004, RAL 9006, RAL 9007 or RAL 9016. Silicone rubber gaskets. Polycarbonate main lens.

Integral EC electronic converter.

Factory installed LED circuit board. LED boards can be easily removed for upgrading. PMMA double lens.

Recommended mounting height 3.0–4.5 m, depending on wattage selected.

Brackets to be ordered separately.

Light source

LED 17-24 W, 4000 K,
for 3000 K refer to www.we-ef.com



Light distribution

[C60]

Accessories

- Mounting, page 256
- Eco Step Dim®, page 264
- Surge protection, page 374





[C60] Controlled distribution, symmetric

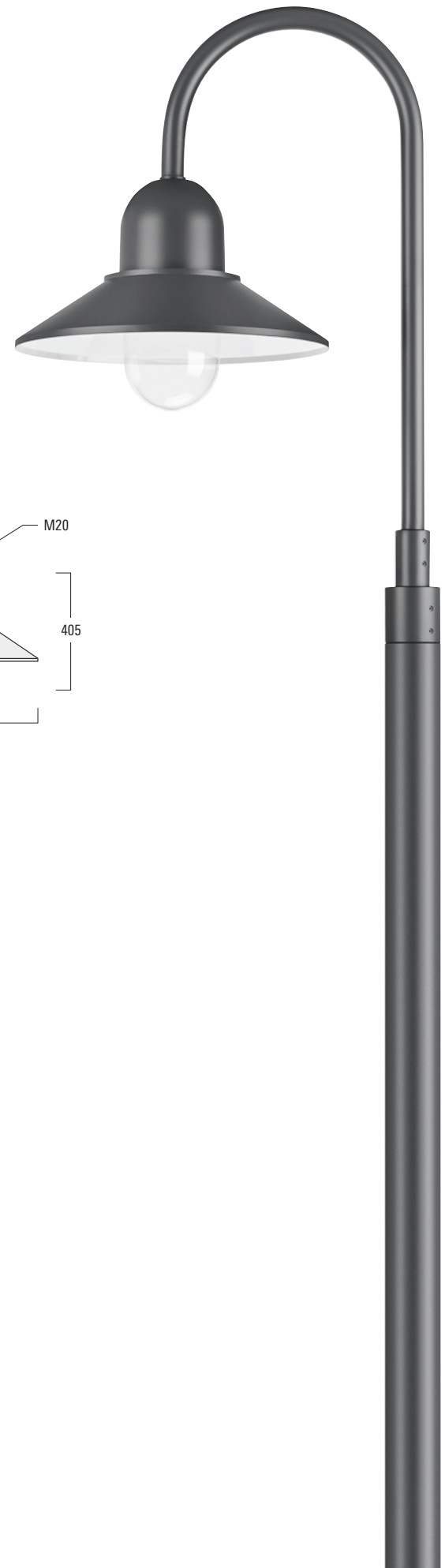

[C60]	Part ID	Light source	K	lm*	Factor**	kg
ALP534	127-1218	LED-FT 17W	4000	2915	1.00	6.1
	127-1220	LED-FT 24W	4000	3940	1.35	6.1

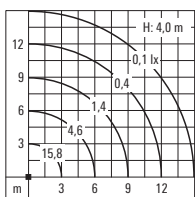
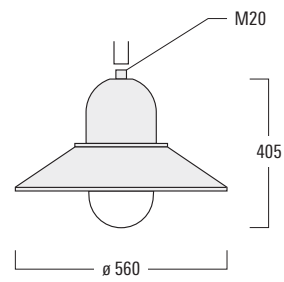

[C60]

* Nominal lumen output based on LED manufacturers data at 25°C T_c. For rated lumens at 25°C T_q and latest data refer to www.we-ef.com.
 ** Multiplier for Isolux value

AOP500 SERIES

Pendant luminaire, controlled distribution, symmetric, canopy highlight feature.

IP55, Class I. IK10. Marine-grade die-cast aluminium alloy. 5CE superior corrosion protection including PCS hardware. Powdercoat finish in RAL 9004, RAL 9006, RAL 9007 or RAL 9016. Silicone rubber gaskets. Polycarbonate main lens.

Integral EC electronic converter.

Factory installed LED circuit board. LED boards can be easily removed for upgrading. PMMA double lens.

Recommended mounting height 3.0–4.5 m, depending on wattage selected.

Brackets to be ordered separately.

Light source

LED 17-24 W, 4000 K,
for 3000 K refer to www.we-ef.com

Light distribution

[C60]

Accessories

- Mounting, page 256
- Eco Step Dim®, page 264
- Surge protection, page 374



Photo: Double lens [C60]



[C60] Controlled distribution, symmetric



[C60]	Part ID	Light source	K	lm*	Factor**	kg
AOP534	127-1261	LED-FT 17W	4000	2915	1.00	7.6
	127-1263	LED-FT 24W	4000	3940	1.35	7.6

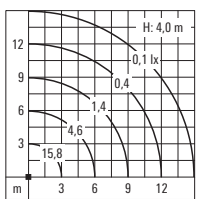
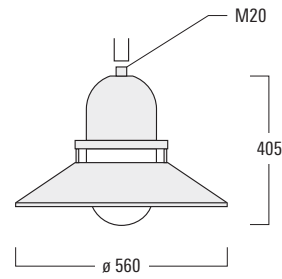

[C60]

* Nominal lumen output based on LED manufacturers data at 25°C T_c. For rated lumens at 25°C T_q and latest data refer to www.we-ef.com.
 ** Multiplier for Isolux value

ASP500 SERIES

Pendant luminaire, side or forward throw distribution, asymmetric.

IP55, Class I. IK10. Marine-grade die-cast aluminium alloy. 5CE superior corrosion protection including PCS hardware. Powdercoat finish in RAL 9004, RAL 9006, RAL 9007 or RAL 9016. Silicone rubber gaskets. Polycarbonate main lens.

Integral EC electronic converter.

Factory installed LED circuit board. LED boards can be easily removed for upgrading. PMMA OLC® LED lenses for superior illumination and glare control.

Recommended mounting height 3.0–6.0 m, depending on wattage selected.

Brackets to be ordered separately.

Light source

LED 24-72 W, 4000 K,
for 3000 K refer to www.we-ef.com

Light distributions

[S65] [R65]

Accessories

- Mounting, page 256
- Eco Step Dim®, page 264
- Surge protection, page 374



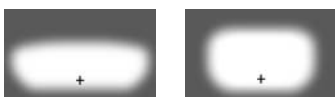

[S65]

[R65]

[S65] Streetlighting distribution

[R65] Rectangular forward throw distribution

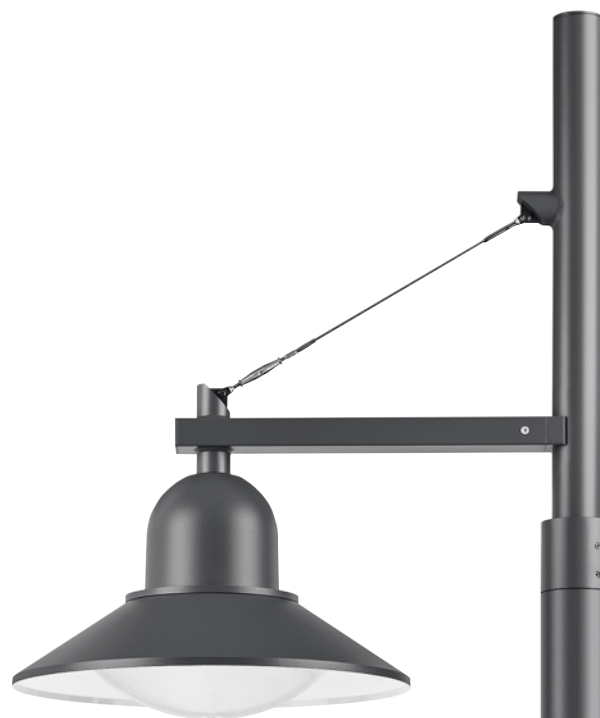

[S65]	Part ID	Light source	K	lm*	Factor**	kg
ASP534	127-1235	12 LED 24W / 700 mA	4000	2951	1.00	8.3
	127-1231	24 LED 48W / 700 mA	4000	5903	2.00	8.3
ASP544	127-1287	24 LED 48W / 700 mA	4000	5903	2.00	13.3
	127-1289	36 LED 72W / 700 mA	4000	8854	3.00	13.3

[R65]	Part ID	Light source	K	lm	Factor*	kg
ASP534	127-1237	12 LED 24W / 700 mA	4000	2951	1.00	8.3
	127-1233	24 LED 48W / 700 mA	4000	5903	2.00	8.3
ASP544	127-1291	24 LED 48W / 700 mA	4000	5903	2.00	13.3
	127-1293	36 LED 72W / 700 mA	4000	8854	3.00	13.3

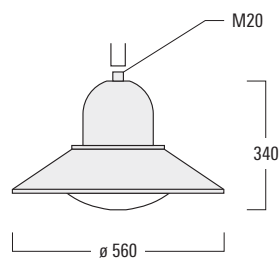

ASP534

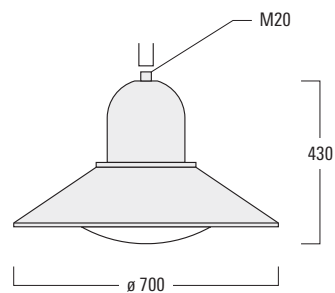

ASP544

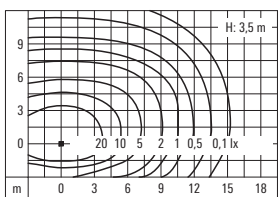

[S65]

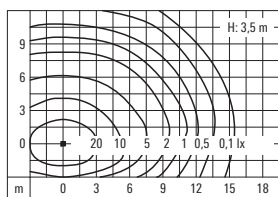

[R65]

* Nominal lumen output based on LED manufacturers data at 85°C T_J. For rated lumens at 25°C T_q and latest data refer to www.we-ef.com.

** Multiplier for Isolux value

BSP500 SERIES

Pendant luminaire, side or forward throw distribution, asymmetric.

IP55, Class I. IK10. Marine-grade die-cast aluminium alloy. 5CE superior corrosion protection including PCS hardware. Powdercoat finish in RAL 9004, RAL 9006, RAL 9007 or RAL 9016. Silicone rubber gaskets. Polycarbonate main lens.

Integral EC electronic converter.

Factory installed LED circuit board. LED boards can be easily removed for upgrading. PMMA OLC® LED lenses for superior illumination and glare control.

Recommended mounting height 3.0–6.0 m, depending on wattage selected.

Brackets to be ordered separately.

Light source

LED 24-72 W, 4000 K,
for 3000 K refer to www.we-ef.com

Light distribution

[S65] [R65]

Accessories

- Mounting, page 256
- Eco Step Dim®, page 264
- Surge protection, page 374



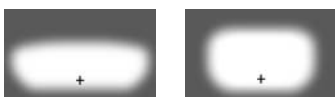

[S65]

[R65]

[S65] Streetlighting distribution

[R65] Rectangular forward throw distribution



[S65]	Part ID	Light source	K	lm*	Factor**	kg
BSP534	127-1269	12 LED 24W / 700 mA	4000	2951	1.00	5.9
	127-1271	24 LED 48W / 700 mA	4000	5903	2.00	5.9
BSP544	127-1303	24 LED 48W / 700 mA	4000	5903	2.00	13.1
	127-1305	36 LED 72W / 700 mA	4000	8854	3.00	13.1

[R65]	Part ID	Light source	K	lm*	Factor**	kg
BSP534	127-1273	12 LED 24W / 700 mA	4000	2951	1.00	5.9
	127-1275	24 LED 48W / 700 mA	4000	5903	2.00	5.9
BSP544	127-1307	24 LED 48W / 700 mA	4000	5903	2.00	13.1
	127-1309	36 LED 72W / 700 mA	4000	8854	3.00	13.1

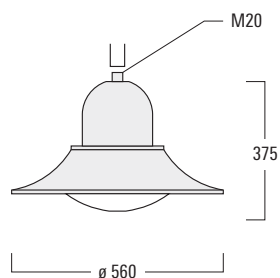

BSP534

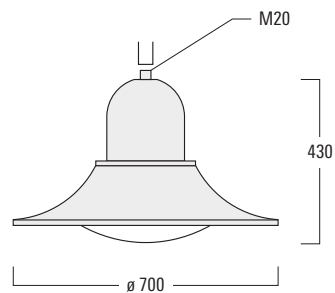

BSP544

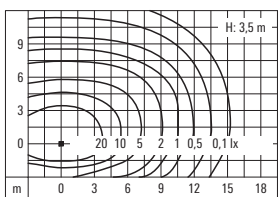

[S65]

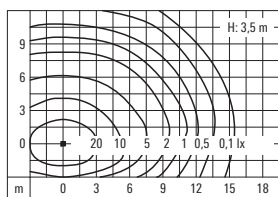

[R65]

* Nominal lumen output based on LED manufacturers data at 85°C T_J. For rated lumens at 25°C T_q and latest data refer to www.we-ef.com.

** Multiplier for Isolux value

MOUNTING ACCESSORIES – ALP/AOP/ASP/BSP500 SERIES

Marine-grade aluminium construction. Powdercoat finish in RAL 9004, RAL 9006, RAL 9007 or RAL 9016.

Wall / Pole brackets BA Series

				H	C	kg
for ... 534	300-0152	BA0-420	Wall bracket	1000	460	2.0
	300-0099	BA1-420	Pole bracket	1000	420	4.0
	300-0104	BA2-420	Pole bracket	1000	500	8.0
	300-0109	BA3-420	Pole bracket	1000	500	10.0
for ... 544	300-0149	BA0-580	Wall bracket	1000	635	2.5
	300-0089	BA1-580	Pole bracket	1000	580	4.5
	300-0090	BA2-580	Pole bracket	1000	675	8.5
	300-0093	BA3-580	Pole bracket	1000	675	10.5

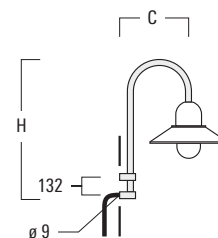

Wall bracket BA0

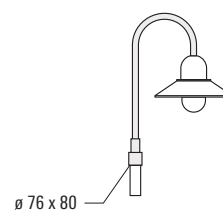

Pole bracket BA1

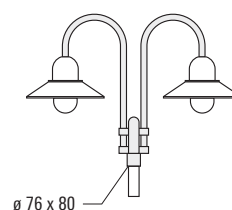

Pole bracket BA2

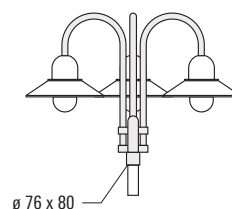

Pole bracket BA3

Wall / Pole brackets BC Series

				H	C	kg
for ... 534	300-0808	BC0-420	Wall bracket	1230	460	2.3
	300-0768	BC1-420	Pole bracket (M8 x 300)	1230	500	2.3
	300-0767	BC2-420	Pole bracket (M8 x 300)	1230	500	4.6
for ... 544	300-0771	BC0-580	Wall bracket	1325	635	2.8
	300-0770	BC1-580	Pole bracket (M8 x 300)	1325	675	2.8
	300-0769	BC2-580	Pole bracket (M8 x 300)	1325	675	5.6

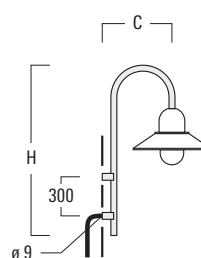

Wall bracket BC0

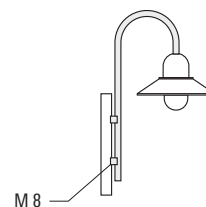

Pole bracket BC1

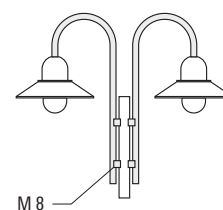

Pole bracket BC2

Wall / Pole brackets DA Series

				D x L	H	C	kg
for ... 534	300-0146	DA0-500	Wall bracket		650	510	5.7
	300-0138	DA1-500	Pole bracket	∅ 76 x 80	700	510	5.7
	300-0141	DA2-500	Pole bracket	∅ 76 x 80	700	510	8.3
	300-0144	DA3-500	Pole bracket	∅ 76 x 80	700	510	10.9
for ... 544	300-0086	DA0-750	Wall bracket		950	720	7.3
	300-0083	DA1-750	Pole bracket	∅ 76 x 130	950	720	7.3
	300-0084	DA2-750	Pole bracket	∅ 76 x 130	950	720	10.6
	300-0085	DA3-750	Pole bracket	∅ 76 x 130	950	720	13.9

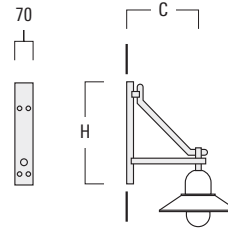

Wall bracket DA0

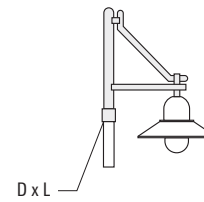

Pole bracket DA1

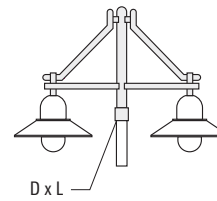

Pole bracket DA2

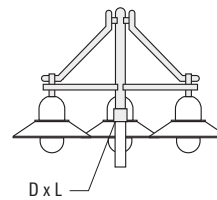

Pole bracket DA3

MOUNTING ACCESSORIES – ALP/AOP/ASP/BSP500 SERIES

Marine-grade aluminium construction. Powdercoat finish in RAL 9004, RAL 9006, RAL 9007 or RAL 9016.

Wall / Pole brackets DB Series				D x L	H	C	kg
for ... 534	300-0169	DB0-500	Wall bracket		650	510	5.5
	300-0190	DB1-500	Pole bracket	∅ 76 x 80	700	510	5.5
	300-0191	DB2-500	Pole bracket	∅ 76 x 80	700	510	7.9
	300-0192	DB3-500	Pole bracket	∅ 76 x 80	700	510	10.3
for ... 544	300-0172	DB0-750	Wall bracket		950	720	7.1
	300-0165	DB1-750	Pole bracket	∅ 76 x 130	950	720	7.1
	300-0168	DB2-750	Pole bracket	∅ 76 x 130	950	720	10.2
	300-0170	DB3-750	Pole bracket	∅ 76 x 130	950	720	13.3

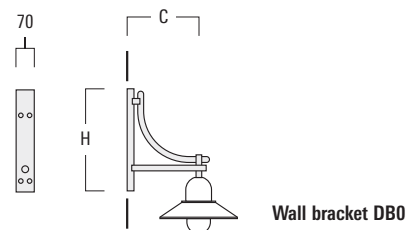

Wall bracket DB0

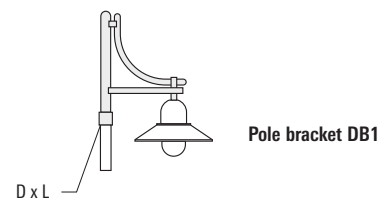

Pole bracket DB1

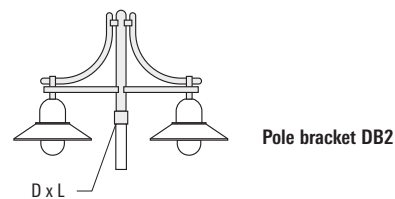

Pole bracket DB2

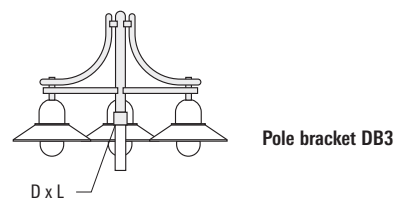

Pole bracket DB3

Wall / Pole brackets DS Series

				D x L	H	C	kg
for ... 534	300-0064	DS0-500	Wall bracket		650	510	2.5
	300-0063	DS1-500	Pole bracket	∅ 76 x 80	725	510	3.9
	300-0066	DS2-500	Pole bracket	∅ 76 x 80	725	510	5.3
	300-0069	DS3-500	Pole bracket	∅ 76 x 80	725	510	6.7
for ... 544	300-0070	DS0-750	Wall bracket		700	750	2.6
	300-0477	DS1-750	Pole bracket	∅ 76 x 130	850	750	5.5
	300-0765	DS2-750	Pole bracket	∅ 76 x 130	850	750	7.2
	300-0766	DS3-750	Pole bracket	∅ 76 x 130	850	750	8.9

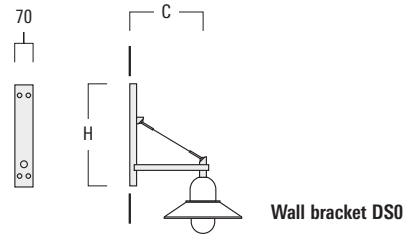

Wall bracket DS0

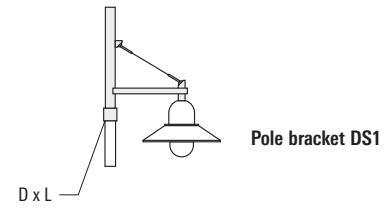

Pole bracket DS1

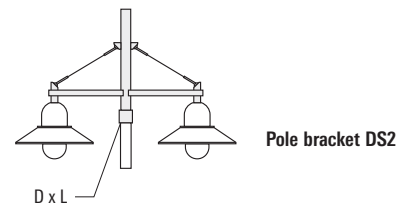

Pole bracket DS2

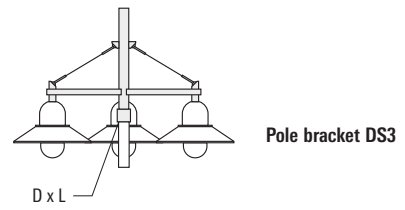

Pole bracket DS3

Eco Step Dim



ECO STEP DIM

- The Intelligence of Light® 262
- Eco Step Dim® Basic 264
- Eco Step Dim® Advanced 265

THE INTELLIGENCE OF LIGHT®

In contrast to conventional lamps, LEDs provide instant light output and enable smooth dimming through efficient and intelligent lighting control technology, such as WE-EF's Eco Step Dim® light management system. Such systems can be programmed for changes in traffic patterns, ambient light or weather. For example, a time-linked dimming program helps to increase the cost-effectiveness of LED lighting solutions in a sustainable way – dimming reduces energy consumption while significantly increasing service life and reducing the decline in the luminous flux of the LEDs. In addition, LED luminaires can be controlled (switched on or off) and programmed either from a central location or on-site.

The WE-EF Eco Step Dim® light management system is available in two variants: Basic and Advanced. WE-EF provides all the necessary components required for implementing a range of control options, including solutions for luminaires in stand-alone operation as well as for extended controls.

	Eco Step Dim® Basic	Eco Step Dim® Advanced
Part ID	430-0001	430-0002
Stand Alone		■
Phase Control	■	
Phase Lines	2	1
Expandable (Future-Proof)	■	■
Class I	■	■
Class II	■	■
Factory programming or on-site	■	■
Applications	One Step Dimming	Five Step Dimming
	Streets and Public Spaces	Increased Flexibility

COMPONENTS

Electronic Controller

Designed for use with outdoor lighting and lighting in the vicinity of buildings, the WE-EF electronic controller enables control of electronic converters fitted with a 1–10 V or DALI interface. The controller can be individually programmed and updated; when in use, it provides all the functions of a light management system, but it does this in stand-alone operation without requiring major commissioning work.



Hand Held Programmer (Optional)

A simple hand-held device. With this device the WE-EF electronic controller can be updated with modified parameters even if installed in a luminaire, without any additional power supply of the controller i.e., on-site. Kit includes adaptor, software and USB cable.

405-0122

Hand Held Programmer



ECO STEP DIM® BASIC

An electronic controller is fitted in the luminaire to reduce luminous flux and power to a preset value. As standard, input is reduced to 50 per cent and luminous flux is reduced to 55 per cent. Control phases (L¹) such as those that are, for example, used in networks using luminaires with two conventional lamps is required to activate the switch.

430-0001 Eco Step Dim® Basic

Features

- An electronic controller, single-step switch, integrated in the luminaire, which reduces luminous flux and power to a pre-set value (i.e., 100% to 50%). Only one level can be activated.
- As standard, luminous flux is reduced to 55 per cent and input is reduced to 50 per cent. Intermediate values (e.g., 25 per cent may be also optionally realised by agreement).
- The system can be activated (on/off) via a timer or photocell.
- The signal for dimming originates in the switch board and can be reset onsite depending on the circumstances.
- Gradual dimming can be programmed for the individual steps.

Eco Step Dim Basic – Schematic

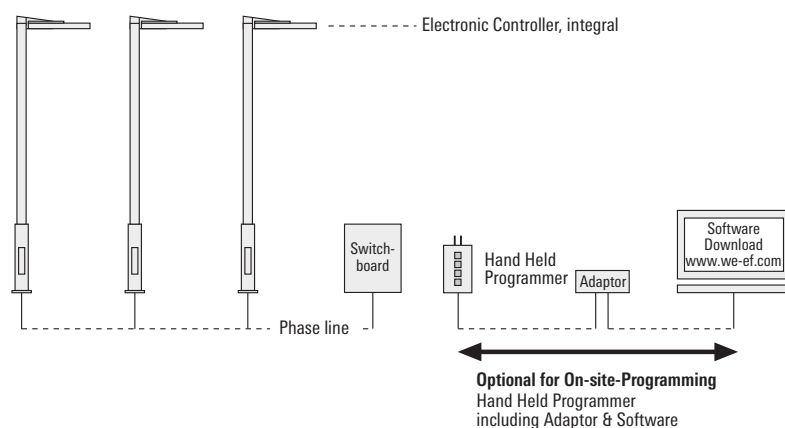

Eco Step Dim Basic – Standard Programming*

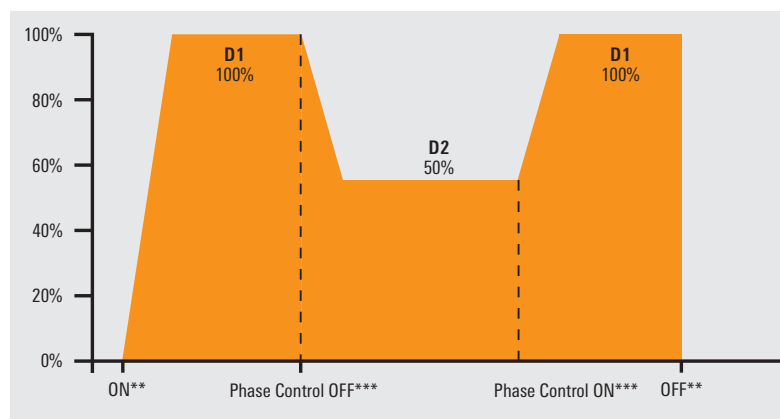

* For customised programming at the factory, please contact WE-EF directly
 ** ON / OFF defined by user, using a dimmer switch (photocell) / timer
 *** Cycle times for the phase are defined by the user

ECO STEP DIM® ADVANCED

A factory-programmed multi-step electronic controller is fitted in the luminaire for reducing the luminous flux and input. The luminaire is operated in stand-alone mode, no additional control phase is required.

430-0002 Eco Step Dim® Advanced

Eco Step Dim® Advanced – Schematic

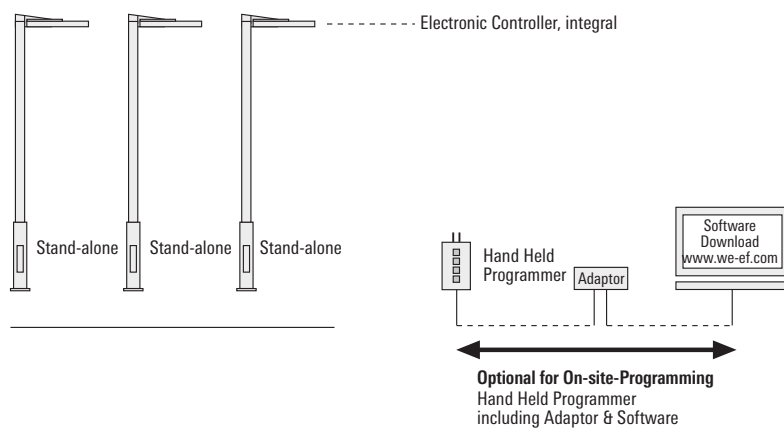

Features

- No separate power source required for dimming control.
- Easy installation with no additional cable required i.e., no control lead (L') required.
- Autonomous system, stand-alone, flexible product that provides maximum savings.
- Applicable in all applications where light level adjustment is needed: Highways, parking lots, urban environments, residential areas etc.
- The dimming schedule can be adapted to 5 dimming levels and various time periods. Can be factory set on request. Can always be adjusted when needed. Reprogramming on site is also possible.
- The standard setting for reduced operation has been programmed for 5 steps.
- Maximum savings can be accomplished by using the optimal schedule for the specific application.
- Mid-point calculation is calibrated so all luminaires exhibit the same dimming characteristics.
- Electronic converter with 1-10 V or DALI interface required.
- The system can be activated (on/off) via a timer or photocell.
- Program can be temporally overwritten.

Eco Step Dim® Advanced – Standard Programming*

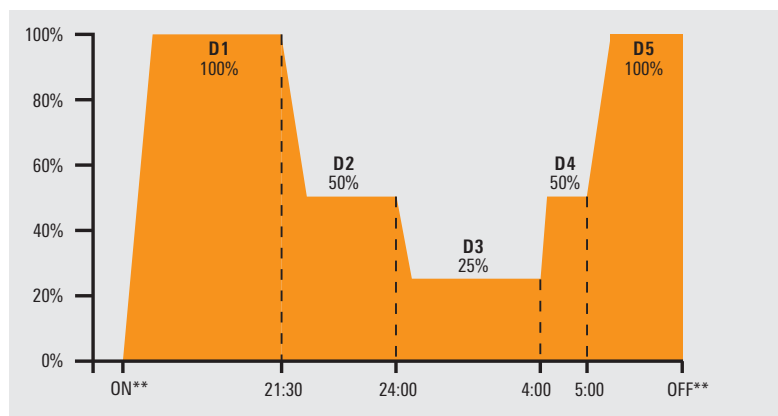

* For customised programming at the factory, please contact WE-EF directly

** ON / OFF defined by user, using a dimmer switch (photocell) / timer

IOS® Beam distributions for RAIL66 system

[B] wide beam, symmetric
[M] medium beam, symmetric
[EE] very narrow beam, symmetric
[EES] very narrow beam, symmetric, 'sharp cut-off'

[B] wide beam, bi-symmetric
[M] medium beam, bi-symmetric
[E] narrow beam, bi-symmetric
[E10] narrow beam, 10° asymmetric
[A45] wide beam, 45° asymmetric

RAIL66 system

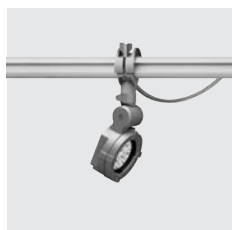

FLC100 LED 268

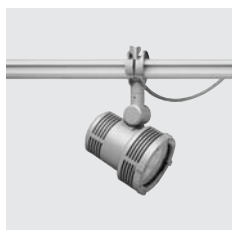

FLC100 270

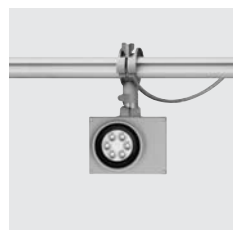

FLD100 LED 272

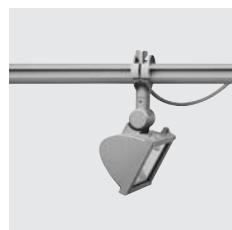

FLB100 274

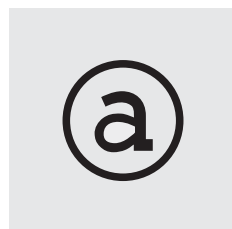

ACCESSORIES

- Mounting 278
- Optical 280

FLC100 SERIES

RAIL66 projector, wide, medium, very narrow or very narrow beam distribution
'sharp cut-off', symmetric.

IP66, Class I. IK07. Marine-grade die-cast aluminium alloy. 5CE superior corrosion protection including PCS hardware. Powdercoat finish in RAL 9004, RAL 9006, RAL 9007 or RAL 9016. Silicone rubber gasket. Safety glass.

EC electronic converter in thermally separated compartment.

Factory installed LED circuit board. LED boards can be easily removed for upgrading.
PMMA LED lens array.

Including 0.4 m of flexible cable enclosed in stainless conduit, in-line connector and mounting clamp for installation to RAIL66 mounting system.

Light source
LED 12-48 W, 3000 K,
for 4000 K refer to www.we-ef.com

Light distributions
[B] [M] [EE] [EES]

Accessories
■ RAIL66 mounting systems, page 282
■ Optical, page 284



Hard Rock Café. Berlin (D). Lighting design: Into Lighting Design, London.



[B] [M] [EE] [EES]

[B] Wide beam distribution, symmetric

[M] Medium beam distribution, symmetric

[EE] Very narrow beam distribution, symmetric

[EES] Very narrow beam distribution, symmetric, 'sharp cut-off'

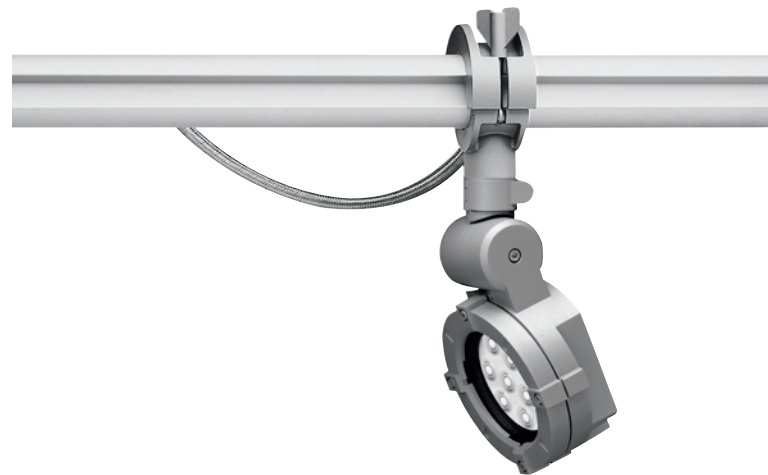

[B]	Part ID	Light source	K	lm*	cd/klm	C ₀ C ₁₈₀	kg
FLC121	145-0088	6 LED 12W / 700 mA	3000	1476	934	25°/25°	2.5
FLC131	146-0530	12 LED 24W / 700 mA	3000	2951	920	25°/25°	3.1
FLC141	146-7070	24 LED 48W / 700 mA	3000	5903	934	25°/25°	4.7

[M]	Part ID	Light source	K	lm*	cd/klm	C ₀ C ₁₈₀	kg
FLC121	145-0043	6 LED 12W / 700 mA	3000	1476	2196	16°/16°	2.5
FLC131	146-0411	12 LED 24W / 700 mA	3000	2951	2196	16°/16°	3.1
FLC141	146-7058	24 LED 48W / 700 mA	3000	5903	2196	16°/16°	4.7

[EE]	Part ID	Light source	K	lm*	cd/klm	C ₀ C ₁₈₀	kg
FLC121	145-0091	6 LED 12W / 700 mA	3000	1476	7207	7°/7°	2.5
FLC131	146-0533	12 LED 24W / 700 mA	3000	2951	7191	7°/7°	3.1
FLC141	146-7072	24 LED 48W / 700 mA	3000	5903	7207	7°/7°	4.7

[EES]	Part ID	Light source	K	lm*	cd/klm	C ₀ C ₁₈₀	kg
FLC121	145-0046	6 LED 12W / 700 mA	3000	1476	22108	5°/5°	2.5
FLC131	146-0414	12 LED 24W / 700 mA	3000	2951	20389	5°/5°	3.1
FLC141	146-7060	24 LED 48W / 700 mA	3000	5903	22108	5°/5°	4.7

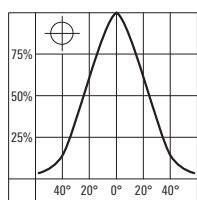
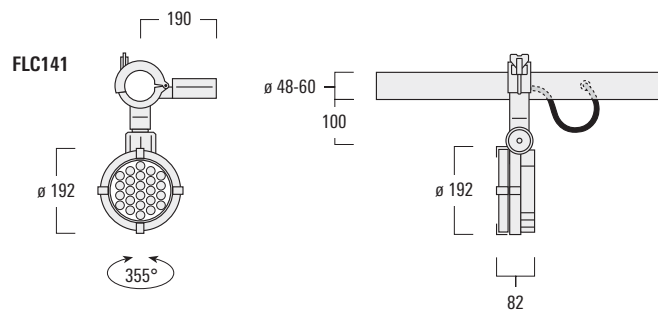
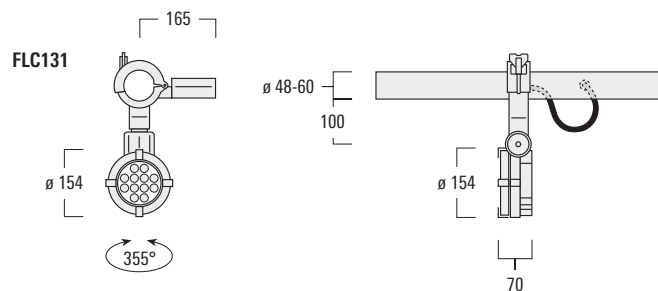
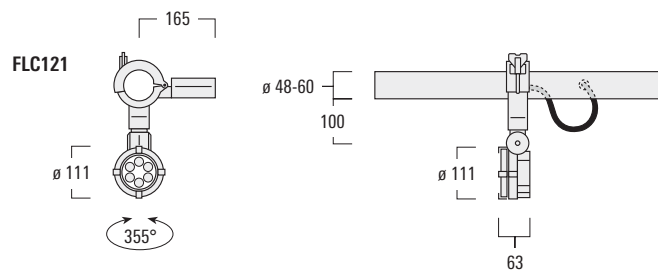

[B]

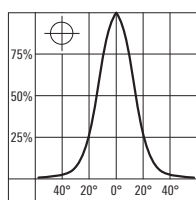

[M]

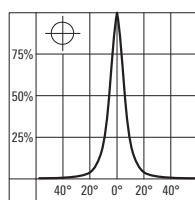

[EE]

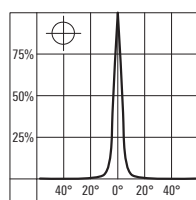

[EES]

* Nominal lumen output based on LED manufacturers data at 85°C T_j. For rated lumens at 25°C T_q and latest data refer to www.we-ef.com.

FLC100 SERIES

RAIL66 projector, wide, medium or very narrow beam distribution, symmetric.

IP66, Class I. IK07. Marine-grade die-cast aluminium alloy. 5CE superior corrosion protection including PCS hardware. Powdercoat finish in RAL 9004, RAL 9006, RAL 9007 or RAL 9016. Silicone rubber gaskets. Safety glass lens. Anodised aluminium reflector.

Electronic transformer for low voltage lamps, or ECG control gear for discharge lamps, in thermally separated compartment.

Including 0.4 m of flexible cable enclosed in stainless conduit, in-line connector and mounting clamp for installation to RAIL66 mounting system.

Light source

QT 65 W

TC 18-32 W

HIT 20-150 W

Light distributions

[B] [M] [EE]

Accessories

■ RAIL66 mounting systems, page 282

■ Optical, page 284



Cabot Circus. Bristol (UK). Architect: Chapman Taylor, Stanton Williams, Alex French. Lighting design: Pinniger and Partners.

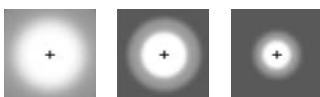

[B] Wide beam distribution, symmetric
 [M] Medium beam distribution, symmetric
 [EE] Very narrow beam distribution, symmetric



[B]	Part ID	Light source	lm	cd/klm	C ₀ C ₁₈₀	kg
FLC121	145-9211 [ECG]	HIT-TC-CE 20W PGJ5	1650	504	30°/30°	2.5
	145-9215 [ECG]	HIT-TC-CE 35W PGJ5	3000	478	30°/30°	2.5
FLC131	146-9622 [ECG]	TC-TEL 18W GX24q-2	1200	160	45°/45°	3.6
FLC141	146-9672 [ECG]	TC-TELI 32W GX24q-3	2400	177	44°/44°	4.8

[M]	Part ID	Light source	lm	cd/klm	C ₀ C ₁₈₀	kg
FLC121	145-9032 [ET]	QT 12 (-LP) ax 65W/c GY6.35/12V	1700	1156	14°/14°	2.3
	145-9036 [ECG]	HIT-TC-CE 20W PGJ5	1650	1810	15°/15°	2.5
	145-9040 [ECG]	HIT-TC-CE 35W PGJ5	3000	1771	15°/15°	2.5
FLC131	146-9630 [ECG]	HIT-CE 70W G12	7300	1296	17°/17°	3.6
FLC141	146-9676 [ECG]	HIT-CE 150W G12	15000	1361	18°/18°	4.8

[EE]	Part ID	Light source	lm	cd/klm	C ₀ C ₁₈₀	kg
FLC121	145-9062 [ET]	QT 12 (-LP) ax 65W/c GY6.35/12V	1700	5517	5°/5°	2.3
	145-9066 [ECG]	HIT-TC-CE 20W PGJ5	1650	10995	5°/5°	2.5
	145-9070 [ECG]	HIT-TC-CE 35W PGJ5	3000	8581	5°/5°	2.5
FLC131	146-9650 [ECG]	HIT-CE 70W G12	7300	7479	4°/4°	3.6
FLC141	146-9682 [ECG]	HIT-CE 150W G12	15000	7146	4°/4°	4.8

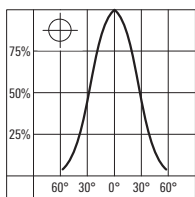
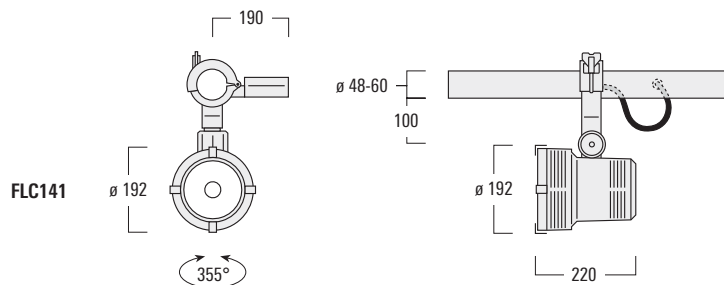
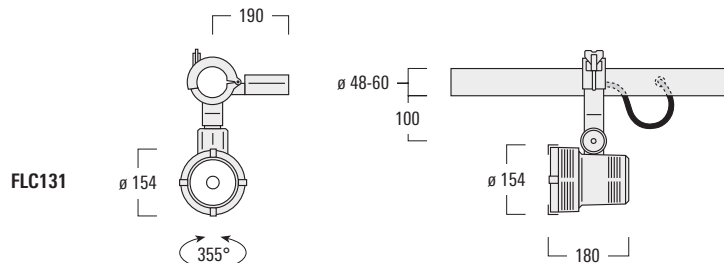
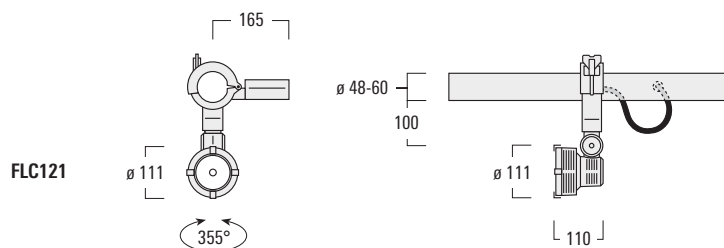

[B]

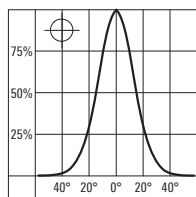

[M]

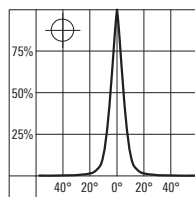

[EE]

FLD100 SERIES

RAIL66 projector, wide, medium, very narrow or very narrow beam distribution
'sharp cut-off', symmetric.

IP66, Class I. IK07. Marine-grade die-cast aluminium alloy. 5CE superior corrosion protection including PCS hardware. Powdercoat finish in RAL 9004, RAL 9006, RAL 9007 or RAL 9016. Silicone rubber gasket. Safety glass.

EC electronic converter in thermally separated compartment.

Factory installed LED circuit board. LED boards can be easily removed for upgrading.
PMMA LED lens array.

Including 0.4 m of flexible cable enclosed in stainless conduit, in-line connector and mounting clamp for installation to RAIL66 mounting system.

Light source

LED 6-24 W, 3000 K,
for 4000 K refer to www.we-ef.com



Light distributions

[B] [M] [EE] [EES]

Accessories

- RAIL66 mounting systems, page 282
- Optical, page 286

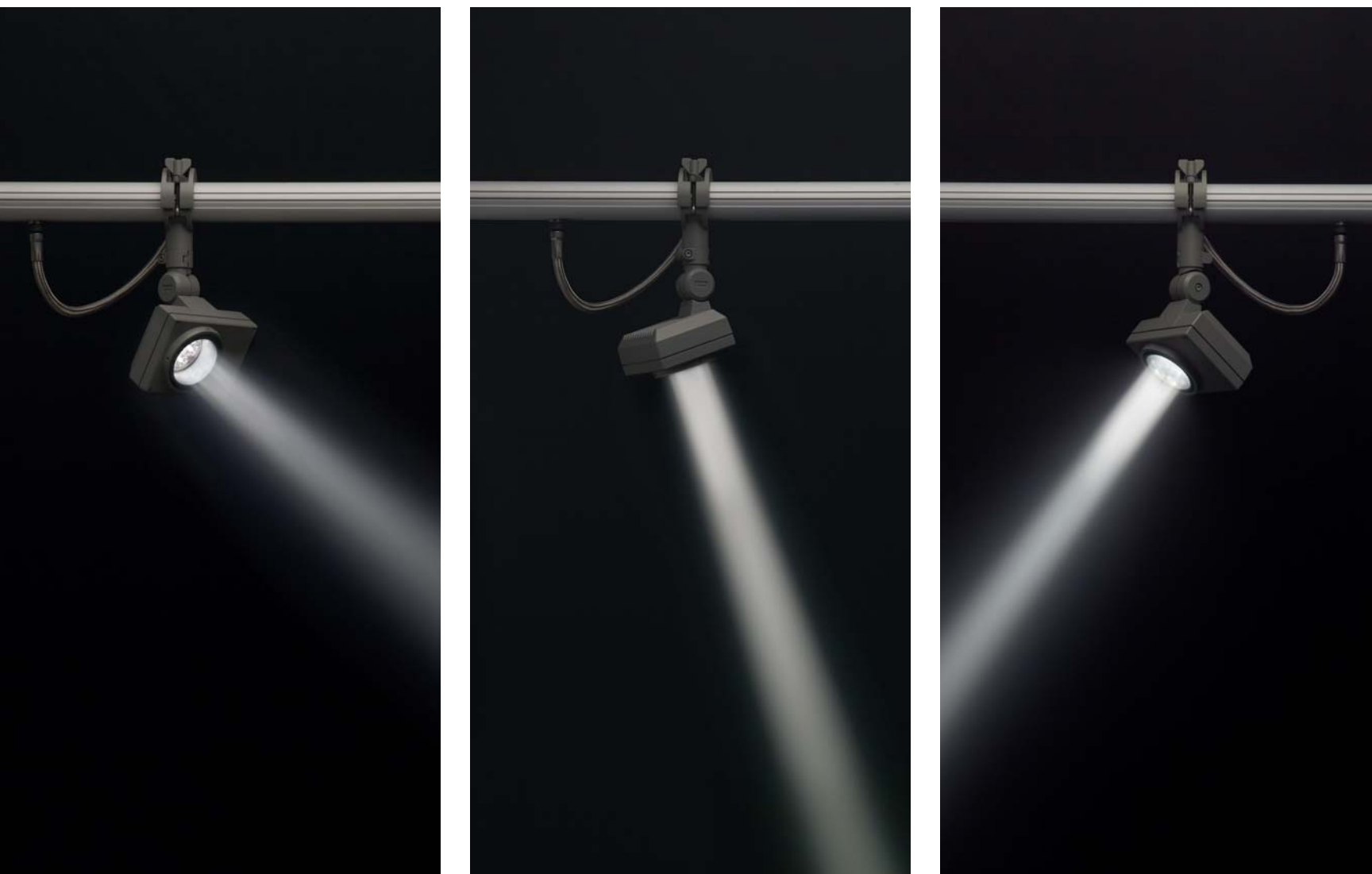

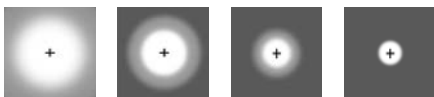

[B] [M] [EE] [EES]

- [B] Wide beam distribution, symmetric
- [M] Medium beam distribution, symmetric
- [EE] Very narrow beam distribution, symmetric
- [EES] Very narrow beam distribution, symmetric, 'sharp cut-off'

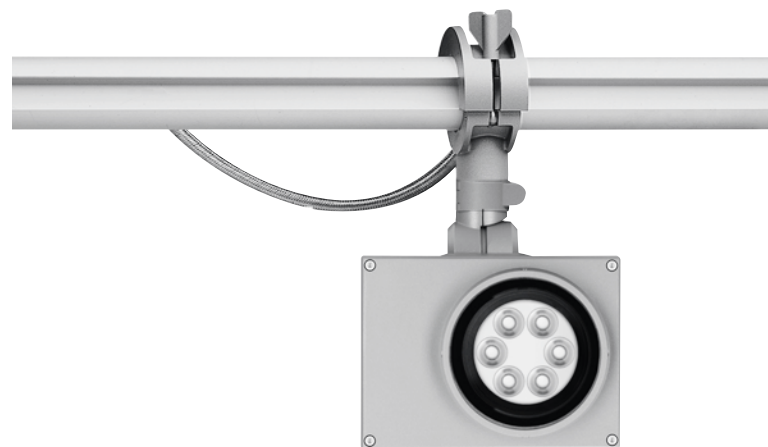

[B]	Part ID	Light source	K	lm*	cd/klm	C ₀ C ₁₈₀	kg
FLD121	145-9511	6 LED 12W / 700 mA	3000	1476	986	23°/23°	2.6
FLD131	145-9608	12 LED 24W / 700 mA	3000	2951	986	23°/23°	3.0

[M]	Part ID	Light source	K	lm*	cd/klm	C ₀ C ₁₈₀	kg
FLD111	145-9809	3 LED 6W / 700 mA	3000	738	1633	21°/21°	2.4
FLD121	145-9509	6 LED 12W / 700 mA	3000	1476	2261	17°/17°	2.6
FLD131	145-9556	12 LED 24W / 700 mA	3000	2951	2261	17°/17°	3.0

[EE]	Part ID	Light source	K	lm*	cd/klm	C ₀ C ₁₈₀	kg
FLD111	145-9810	3 LED 6W / 700 mA	3000	738	7530	7°/7°	2.4
FLD121	145-9513	6 LED 12W / 700 mA	3000	1476	7524	7°/7°	2.6
FLD131	145-9557	12 LED 24W / 700 mA	3000	2951	7524	7°/7°	3.0

[EES]	Part ID	Light source	K	lm*	cd/klm	C ₀ C ₁₈₀	kg
FLD111	145-9811	3 LED 6W / 700 mA	3000	738	16462	5°/5°	2.4
FLD121	145-9515	6 LED 12W / 700 mA	3000	1476	19392	5°/5°	2.6
FLD131	145-9609	12 LED 24W / 700 mA	3000	2951	19392	5°/5°	3.0

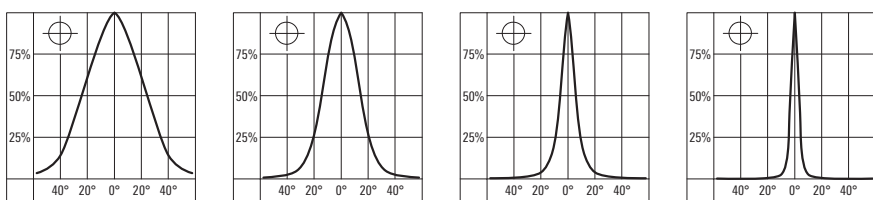
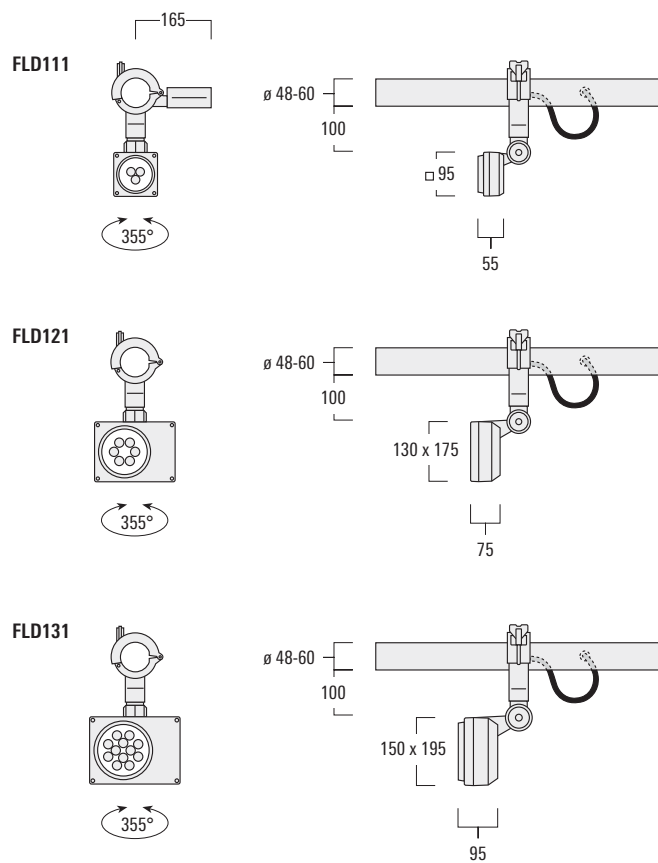

[B] [M] [EE] [EES]

* Nominal lumen output based on LED manufacturers data at 85°C T_j. For rated lumens at 25°C T_q and latest data refer to www.we-ef.com.

FLB100 SERIES

RAIL66 floodlight, wide, medium or narrow beam distribution, bi-symmetric.

IP66, Class I. IK08. Marine-grade die-cast aluminium alloy. 5CE superior corrosion protection including PCS hardware. Powdercoat finish in RAL 9004, RAL 9006, RAL 9007 or RAL 9016. Silicone rubber gaskets. Safety glass lens. Anodised aluminium reflector.

ECG control gear for discharge lamps, in thermally separated compartment.

Including 0.4 m of flexible cable enclosed in stainless conduit, in-line connector and mounting clamp for installation to RAIL66 mounting system.

Light source

QT 300 W

HIT 70-150 W

Light distributions

[B] [M] [E]

Accessories

■ RAIL66 mounting systems, page 282

■ Optical, page 288

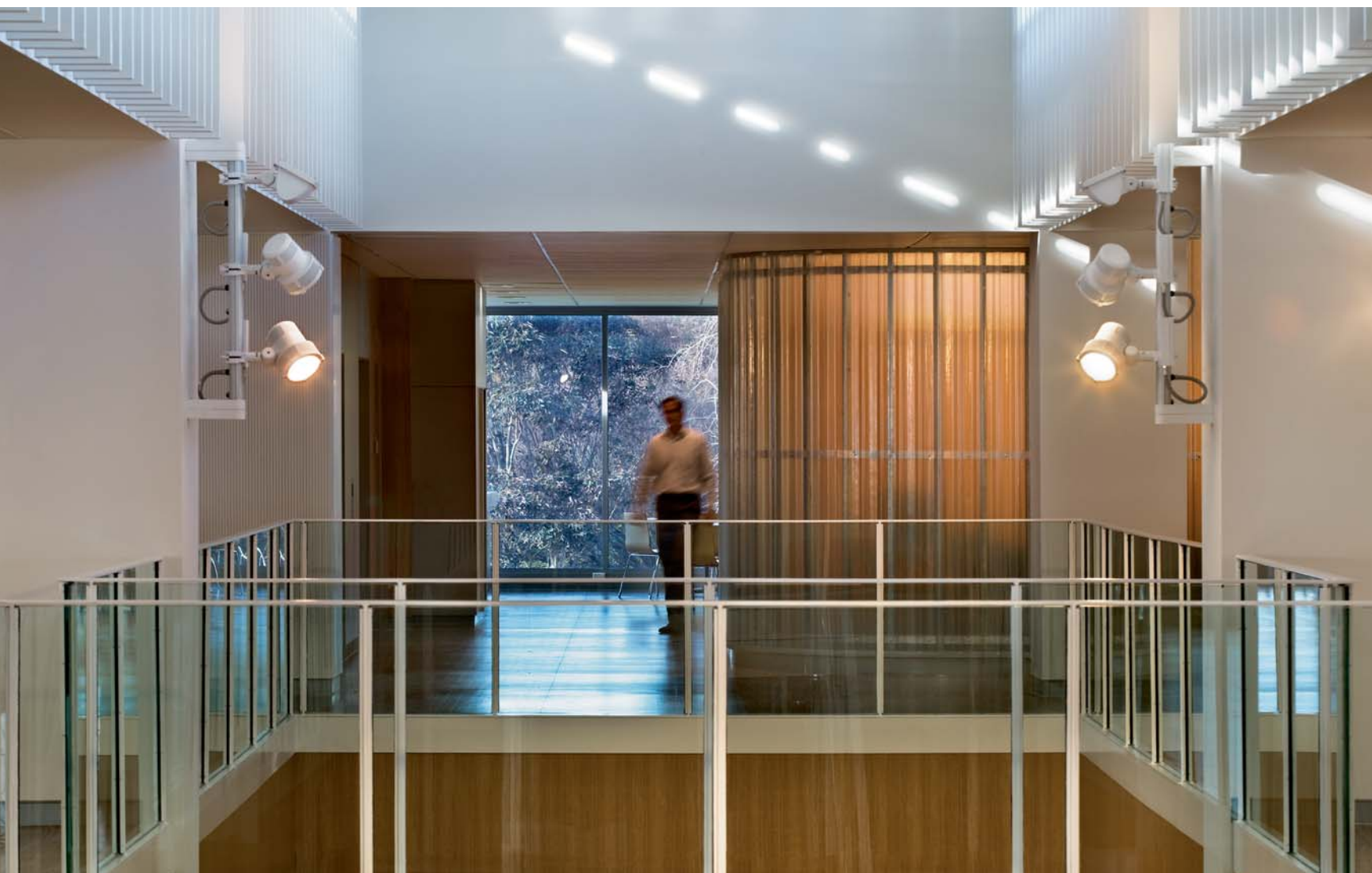

ASB Fitout. Auckland (NZ). Lighting design: Richard Bracebridge, Lightworks.



[B]

[M]

[E]

- [B] Wide beam distribution, bi-symmetric
- [M] Medium beam distribution, bi-symmetric
- [E] Narrow beam distribution, bi-symmetric

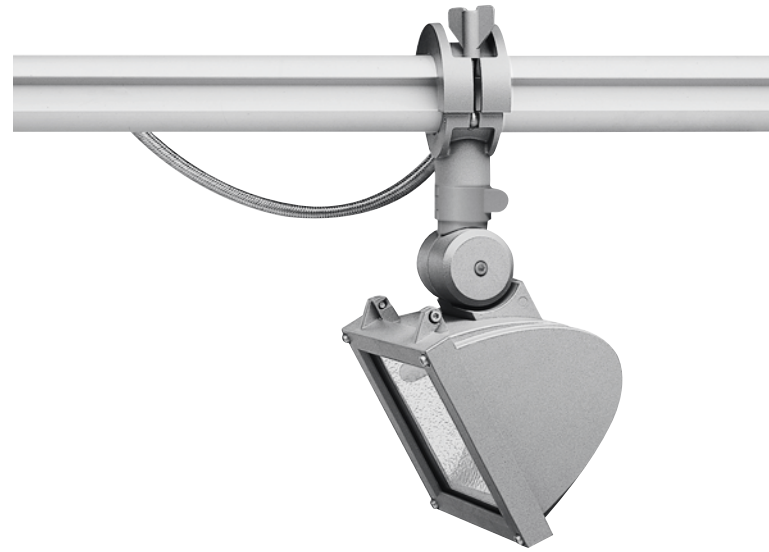

[B]	Part ID	Light source	lm	cd/klm	C ₀ C ₁₈₀	C ₉₀ C ₂₇₀	kg
FLB141	161-7300	QT-DE 300W RX7s	5300	675	25°/25°	31°/31°	3.8
	161-7304 [ECG]	HIT-DE-CE 70W RX7s	6800	638	25°/25°	32°/32°	4.7
	161-7308 [ECG]	HIT-DE-CE 150W RX7s	14500	665	25°/25°	32°/32°	4.8
[M]	Part ID	Light source	lm	cd/klm	C ₀ C ₁₈₀	C ₉₀ C ₂₇₀	kg
FLB141	161-7332 [ECG]	HIT-DE-CE 70W RX7s	6800	1011	15°/15°	32°/32°	4.7
	161-7336 [ECG]	HIT-DE-CE 150W RX7s	14500	926	16°/16°	32°/32°	4.8
[E]	Part ID	Light source	lm	cd/klm	C ₀ C ₁₈₀	C ₉₀ C ₂₇₀	kg
FLB141	161-7360 [ECG]	HIT-DE-CE 70W RX7s	6800	1716	7°/7°	33°/33°	4.7
	161-7364 [ECG]	HIT-DE-CE 150W RX7s	14500	1426	9°/9°	33°/33°	4.8

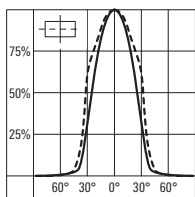
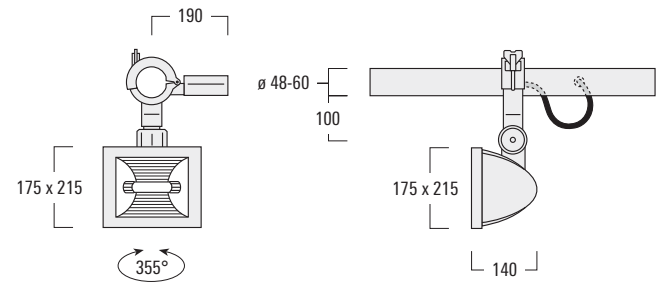

[B]

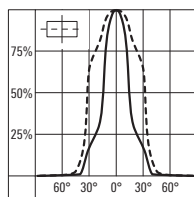

[M]

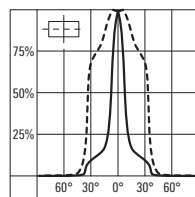

[E]

FLB100 SERIES

RAIL66 floodlight, narrow or wide beam distribution, asymmetric.

IP66, Class I. IK08. Marine-grade die-cast aluminium alloy. 5CE superior corrosion protection including PCS hardware. Powdercoat finish in RAL 9004, RAL 9006, RAL 9007 or RAL 9016. Silicone rubber gaskets. Safety glass lens. Anodised aluminium reflector.

ECG control gear for discharge lamps, in thermally separated compartment.

Including 0.4 m of flexible cable enclosed in stainless conduit, in-line connector and mounting clamp for installation to RAIL66 mounting system.

Light source
QT 300 W
HIT 70-150 W

Light distribution
[E10] [A45]

Accessories

- RAIL66 mounting systems, page 282
- Optical, page 288



ASB Fitout. Auckland (NZ). Lighting design: Richard Bracebridge, Lightworks.

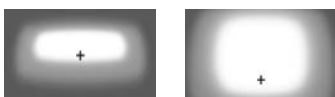

[E10]

[A45]

[E10] Narrow beam distribution, 10° asymmetric

[A45] Wide beam distribution, 45° asymmetric

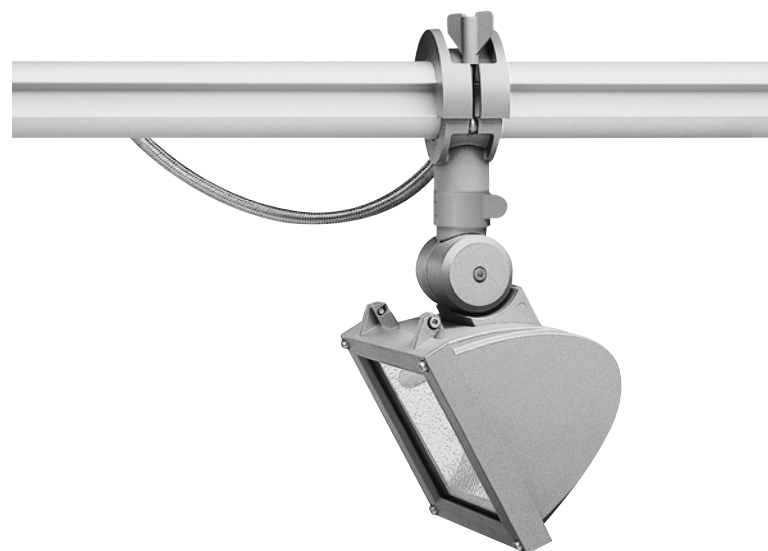

[E10]	Part ID	Light source	lm	cd/klm	C ₀ C ₁₈₀	C ₉₀ C ₂₇₀	kg
FLB141	161-7388 [ECG]	HIT-DE-CE 70W RX7s	6800	1645	5°/9°	34°/34°	4.7
	161-7392 [ECG]	HIT-DE-CE 150W RX7s	14500	1128	8°/12°	34°/34°	4.8

[A45]	Part ID	Light source	lm	cd/klm	C ₀ C ₁₈₀	C ₉₀ C ₂₇₀	kg
FLB141	161-7406	QT-DE 300W R7s	5300	408	31°/21°	38°/38°	3.9
	161-7410 [ECG]	HIT-DE-CE 70W RX7s	6800	478	30°/21°	38°/38°	4.9
	161-7414 [ECG]	HIT-DE-CE 150W RX7s	14500	442	25°/26°	40°/40°	5.0

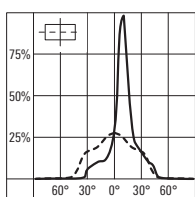
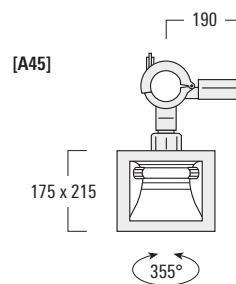
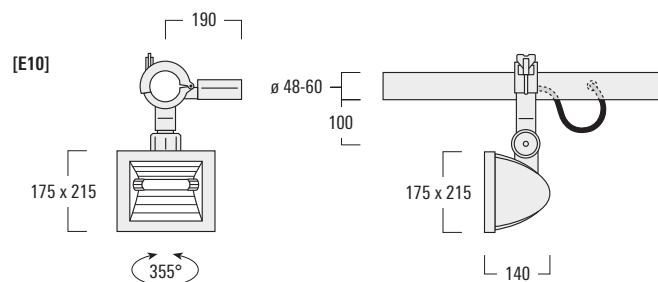

[E10]

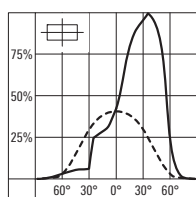

[A45]

RAIL66 UNIVERSAL

For RAIL66 projectors and floodlights.

IP66. Marine-grade all aluminium construction. 5CE superior corrosion protection including PCS hardware. Powdercoat finish in RAL 9004, RAL 9006, RAL 9007 or RAL 9016. Anodised rail extrusion, featuring countersunk, IP rated compact mains outlets and internal wiring.

RAIL66 Universal

Suitable for installation in any desired orientation to walls, under roof and ceiling structures.

		L1	L2	kg
310-9200	for 2 projectors or floodlights	1150	1045	5.9
310-9202	for 3 projectors or floodlights	1150	1045	5.9
310-9210	for 3 projectors or floodlights	1650	1545	7.2
310-9212	for 4 projectors or floodlights	1650	1545	7.2
310-9220	for 4 projectors or floodlights	2150	2045	8.5
310-9222	for 6 projectors or floodlights	2150	2045	8.5

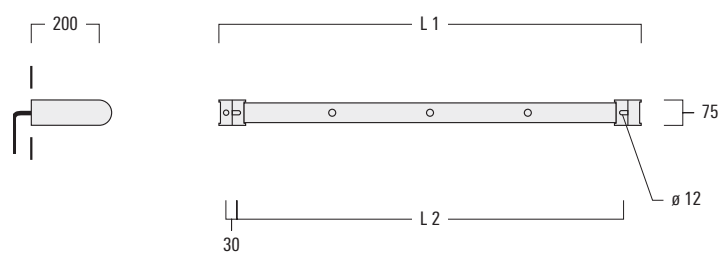

RAIL66 Surface Fitters (Pair)

The optional Flat Surface Fitters (pair) provide enhanced mounting surface coverage and facilitate concealing of a recessed junction box.

	L	kg
310-9290	1070 / 1570 / 2070	1.7

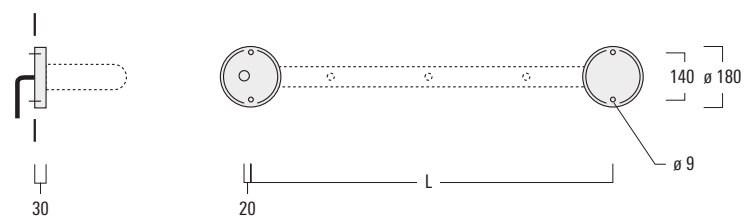

RAIL66 Column Fitters (Pair)

The optional Column Fitters (pair) allow installation to pipe structures and columns of min. 100 mm diameter.

	L	kg
310-9294	1115 / 1615 / 2115	0.9

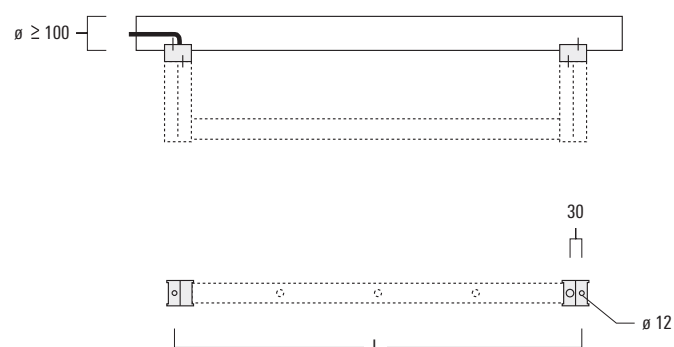

RAIL66 CANTILEVER & RAIL66 MOBILE

For RAIL66 projectors and floodlights.

IP66. Marine-grade all aluminium construction. 5CE superior corrosion protection including PCS hardware. Powdercoat finish in RAL 9004, RAL 9006, RAL 9007 or RAL 9016 or Classic Silver. Anodised rail extrusion, featuring countersunk, IP rated compact mains outlets and internal wiring.

RAIL66 Cantilever

featuring a concealed termination chamber, has been designed for horizontal wall mounting.

Particularly suitable for facade lighting applications.

		L1	L2	kg
310-9230	for 2 projectors or floodlights	1150	1070	12.0
310-9232	for 3 projectors or floodlights	1150	1070	12.0
310-9240	for 3 projectors or floodlights	1650	1570	13.3
310-9242	for 4 projectors or floodlights	1650	1570	13.3
310-9250	for 4 projectors or floodlights	2150	2070	14.6
310-9252	for 6 projectors or floodlights	2150	2070	14.6

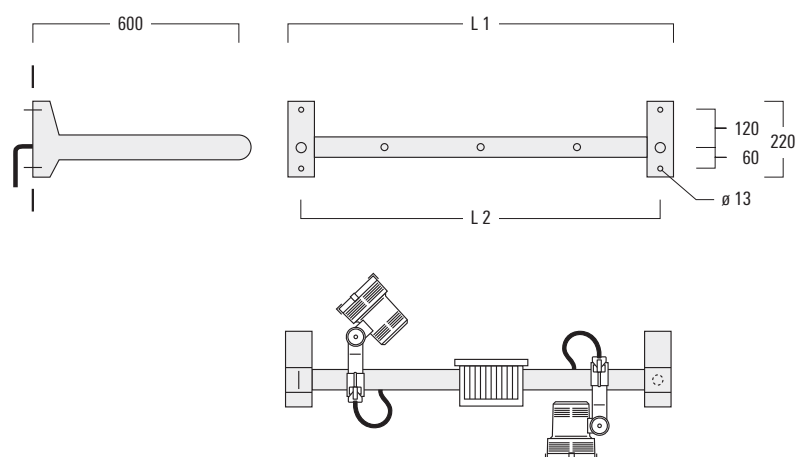

RAIL66 Mobile

includes 3 m of flexible cable and plug, and is particularly suitable for mobile installations at showrooms, exhibitions, outdoor events, etc.

		L	kg
310-9260	for 2 projectors or floodlights	1150	9.3
310-9264	for 3 projectors or floodlights	1150	9.3
310-9270	for 3 projectors or floodlights	1650	10.6
310-9274	for 4 projectors or floodlights	1650	10.6
310-9280	for 4 projectors or floodlights	2150	11.9
310-9284	for 6 projectors or floodlights	2150	11.9

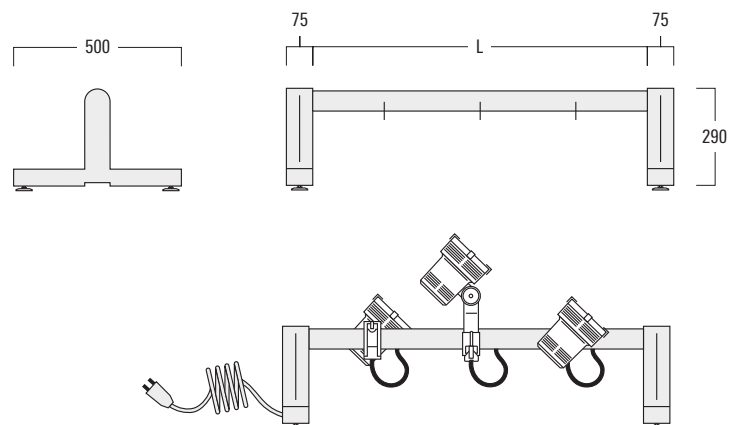

OPTICAL ACCESSORIES – FLC100 SERIES

Internal Accessories

A maximum of one internal optical accessory.

Flood lens IO-360

for FLC121	145-0142
for FLC131	146-0623
for FLC141	146-0624

Linear spread lens IO-180

for FLC121	145-0050
for FLC131	146-0418
for FLC141	146-0439

Wallwash lens IO-20*

for FLC121 [M]	145-0145
for FLC131 [M]	146-0645
for FLC141 [M]	146-0646

Honeycomb louvre IW**

for FLC121	145-0143
for FLC131	146-0625
for FLC141	146-0626

* ideal for uniform wall washing applications

** not for [B] version

External Accessories

A maximum of one external optical accessory.

Wire guard EG

for FLC121	145-9190
for FLC131	146-0158
for FLC141	146-0231

Glare shield ES

for FLC121	145-9192
for FLC131	146-0156
for FLC141	146-0229

Snoot ET

for FLC121	145-0030
for FLC131	146-0397
for FLC141	146-0398

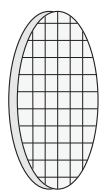

IO

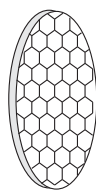

IW



Frame



EG



ES



ET

OPTICAL ACCESSORIES – FLC100 SERIES

Internal Accessories

A maximum of two internal optical accessories.

Flood lens IO-360

for FLC121	145-9174
for FLC131	146-0258
for FLC141	146-0122

Linear spread lens IO-180

for FLC121	145-9172
for FLC131	146-0257
for FLC141	146-0123

Colour filter IF	red	green	blue	yellow
for FLC121	145-9176	145-9178	145-9180	145-9182
for FLC131	146-0262	146-0260	146-0259	146-0261
for FLC141	146-0141	146-0135	146-0119	146-0138

Source shield IQ

for FLC121 [EE]	145-9170
for FLC131 [EE]	146-0263
for FLC141 [EE]	146-0264

External Accessories

A maximum of one external optical accessory.

Wire guard EG

for FLC121	145-9190
for FLC131	146-0158
for FLC141	146-0231

Glare shield ES

for FLC121	145-9192
for FLC131	146-0156
for FLC141	146-0229

Snoot ET

for FLC121	145-9194
for FLC131	146-0157
for FLC141	146-0230

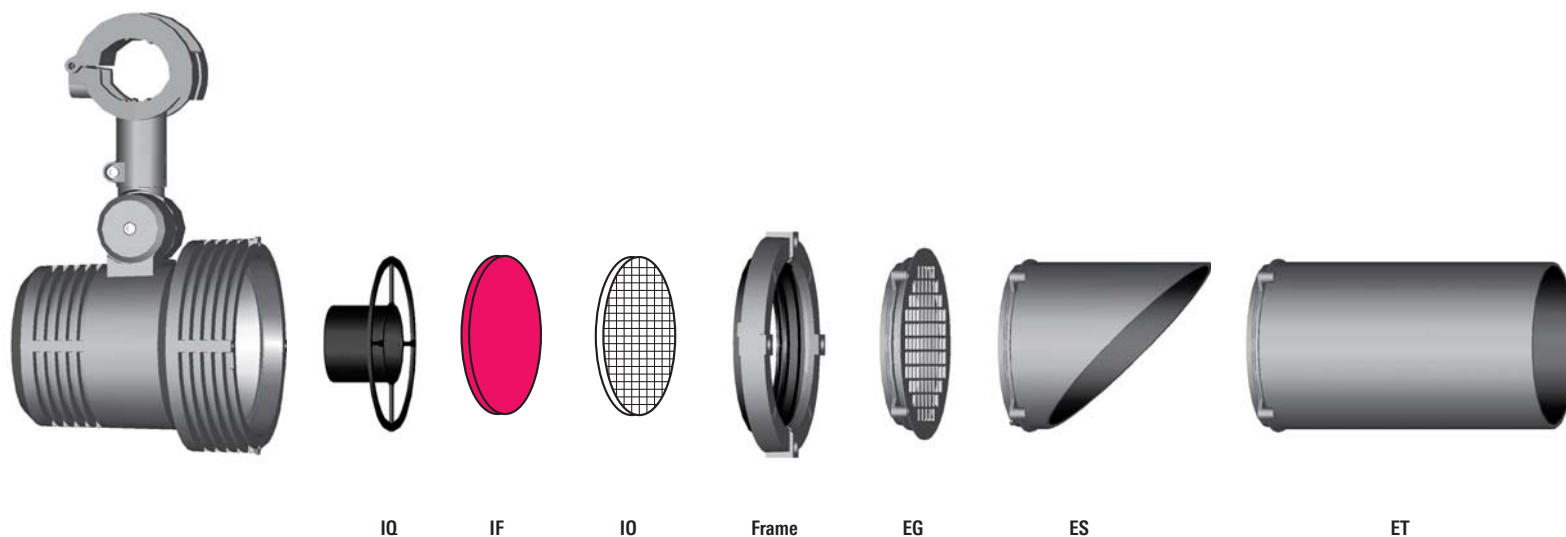

OPTICAL ACCESSORIES – FLD100 SERIES

Internal Accessories

Wallwash lens IO-20*

for FLD111 [M]	145-9846
for FLD121 [M]	145-9479
for FLD131 [M]	145-9577

* ideal for uniform wall washing applications, factory fitted only.

External Accessories

A maximum of two external optical accessories, such as glare shield or snoot, plus flood or spread lens. If a flood or spread lens is used as a 'stand alone' accessory, an optical adaptor is required – to be ordered separately.

Optical adaptor

for FLD111	145-9830
for FLD121	145-9530
for FLD131	145-9570

Flood lens EO-360

for FLD111	145-9834
for FLD121	145-9534
for FLD131	145-9574

Linear spread lens EO-180

for FLD111	145-9833
for FLD121	145-9533
for FLD131	145-9573

Glare shield ES

for FLD111	145-9831
for FLD121	145-9531
for FLD131	145-9571

Snoot ET

for FLD111	145-9832
for FLD121	145-9532
for FLD131	145-9572



IO

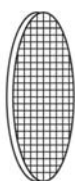

EO



EA



ES



ET



Robina Town Centre. Gold Coast, Queensland (AUS).

OPTICAL ACCESSORIES – FLB100 SERIES

Internal

A maximum of two internal optical accessories. The optical adaptor IA has to be ordered separately. Refer to listing below to determine need for optical adaptor.

Flood lens IO-360*

for FLB141 [M] [E] [E10] 161-9127

Wallwash lens IO-180*

for FLB141 [M] [E] [E10] 161-9126

Colour filter IF**/**

	red	green	blue	yellow
for FLB141	161-9131	161-9129	161-9128	161-9130

Horizontal louvre IL*

for FLB141 [B] [M] 161-9116

for FLB141 [E] 161-9113

Linear source shield IQ*

for FLB141 [E] 161-9117

Optical adaptor IA

for FLB141 161-9115

External

A maximum of one external optical accessory.

Wire guard EG

for FLB141 161-9118

Glare shield ES

for FLB141 [B] [M] [E] 161-9121

Barn doors ED

for FLB141 161-9119

* Requires optical adaptor IA which has to be ordered separately.

** Dichroic colour filters, in combination with bi-symmetric or asymmetric reflectors, exhibit a pronounced 'rainbow effect'.

If this is not suitable, contact your local WE-EF representative for optional absorption colour filters.

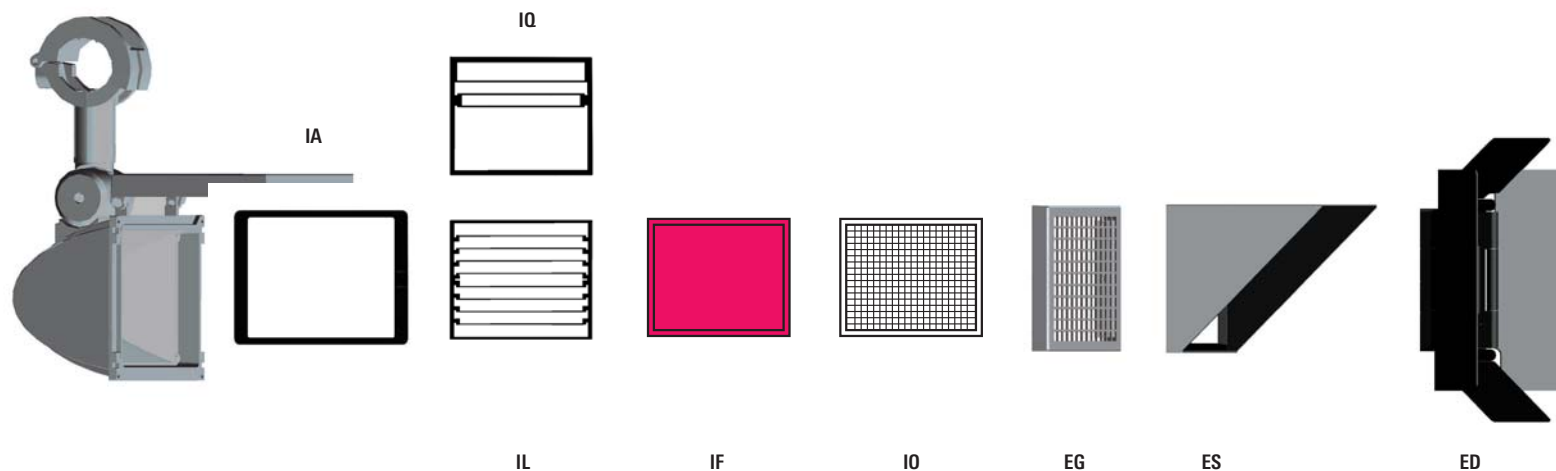

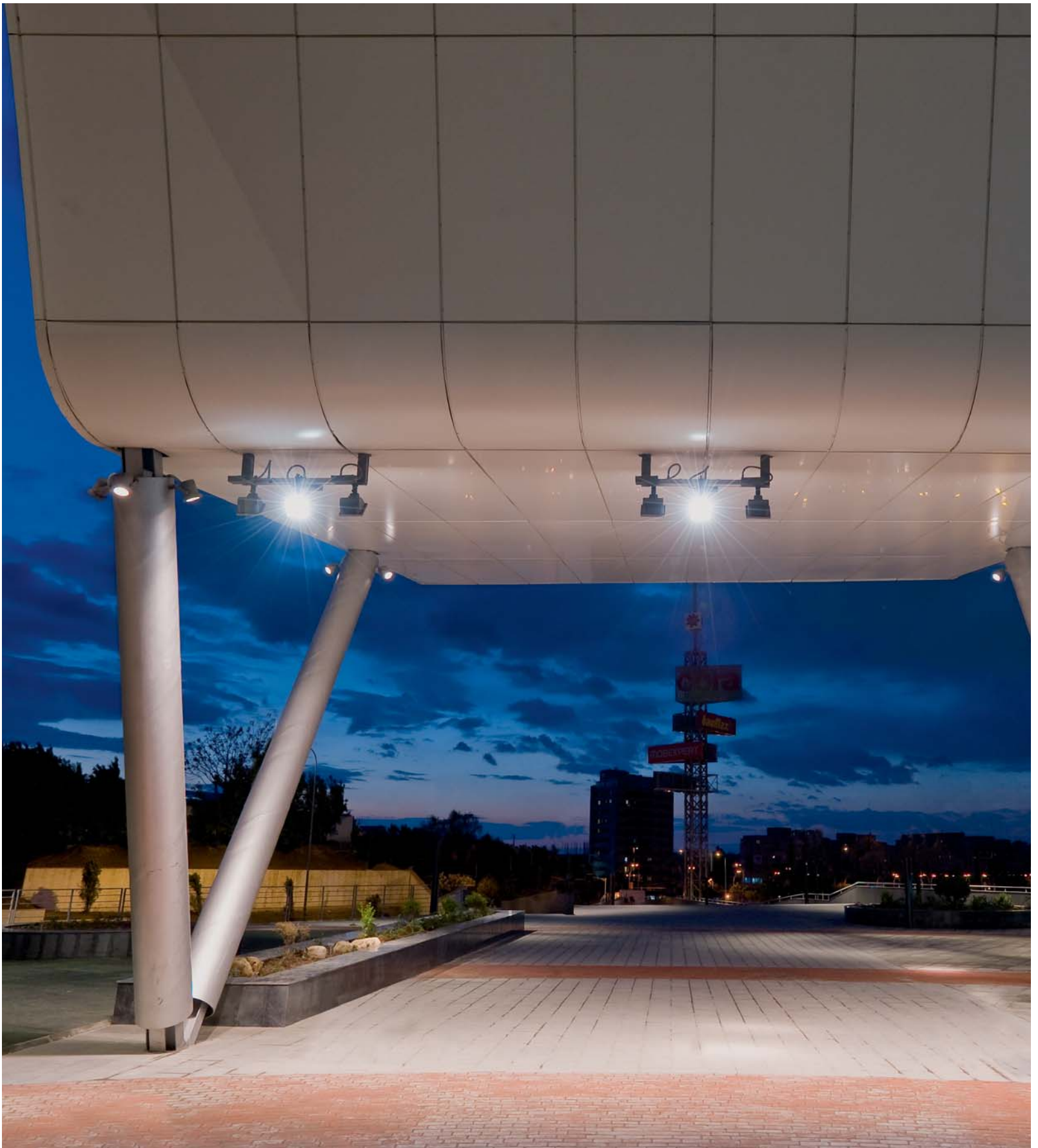

Sun Plaza Shopping Mall. Bucarest (RO). Architects: Chapman Taylor, London. Lighting design: Scott Beleuchtung, Berlin.

IOS® Beam distributions for projectors

- [B] wide beam, symmetric
- [M] medium beam, symmetric
- [E] narrow beam, symmetric
- [EE] very narrow beam, symmetric
- [EES] very narrow beam, symmetric, 'sharp cut-off'

- [BL] profile projector for zoom, gobo or framing applications

Projectors



FLC100 LED 288

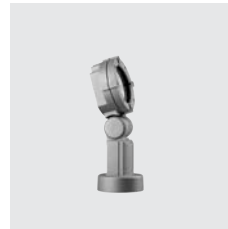

FLC100 LED 290

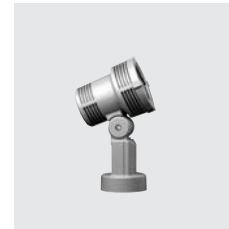

FLC100 292



ACCESSORIES FLC100
 ■ Mounting 294
 ■ Optical 296



FLD100 LED 298



ACCESSORIES FLD100
 ■ Mounting 300
 ■ Optical 301



FLC200 LED 302



FLC200 304



FLC200 CC 316



FLC200 BL 318



FLC200 CC + BL 320



ACCESSORIES FLC200
 ■ Mounting 322
 ■ Electrical 323
 ■ Optical 324

FLC100 SERIES

Projector, wide, medium, very narrow beam or very narrow beam distribution 'sharp cut-off', symmetric.

IP55, Class I. IK07. Marine-grade die-cast aluminium alloy. 5CE superior corrosion protection including PCS hardware. Powdercoat finish in RAL 9004, RAL 9006, RAL 9007 or RAL 9016. Silicone rubber gasket. Safety glass.

EC electronic converter in thermally separated compartment.

Factory installed LED circuit board. LED boards can be easily removed for upgrading. PMMA LED lens array.

Knuckle permits 350° horizontal and 90° vertical aiming of optics.

Light source

LED 12-48 W, 3000 K,
for 4000 K refer to www.we-ef.com

Light distributions

[B] [M] [EE] [EES]

Accessories

■ Optical, page 296





[B] [M] [EE] [EES]

- [B] Wide beam distribution, symmetric
- [M] Medium beam distribution, symmetric
- [EE] Very narrow beam distribution, symmetric
- [EES] Very narrow beam distribution, symmetric, 'sharp cut-off'



[B]	Part ID	Light source	K	lm*	Factor**	kg
FLC121	145-0070	6 LED 12W / 700 mA	3000	1476	0.50	2.9
FLC131	146-0512	12 LED 24W / 700 mA	3000	2951	1.00	4.5
FLC141	146-7066	24 LED 48W / 700 mA	3000	5903	1.50	6.3

[M]	Part ID	Light source	K	lm*	Factor**	kg
FLC121	145-0037	6 LED 12W / 700 mA	3000	1476	0.50	2.9
FLC131	146-0405	12 LED 24W / 700 mA	3000	2951	1.00	4.5
FLC141	146-7054	24 LED 48W / 700 mA	3000	5903	1.50	6.3

[EE]	Part ID	Light source	K	lm*	Factor**	kg
FLC121	145-0073	6 LED 12W / 700 mA	3000	1476	0.50	2.9
FLC131	146-0515	12 LED 24W / 700 mA	3000	2951	1.00	4.5
FLC141	146-7068	24 LED 48W / 700 mA	3000	5903	1.50	6.3

[EES]	Part ID	Light source	K	lm*	Factor**	kg
FLC121	145-0040	6 LED 12W / 700 mA	3000	1476	0.50	2.9
FLC131	146-0408	12 LED 24W / 700 mA	3000	2951	1.00	4.5
FLC141	146-7056	24 LED 48W / 700 mA	3000	5903	1.50	6.3

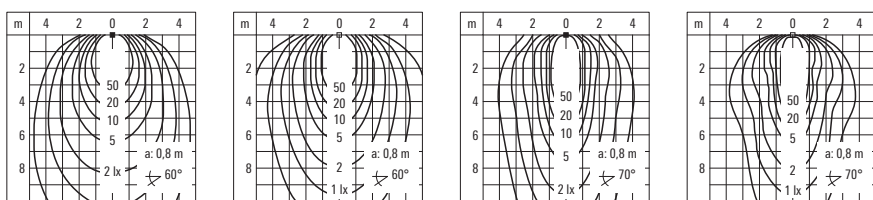
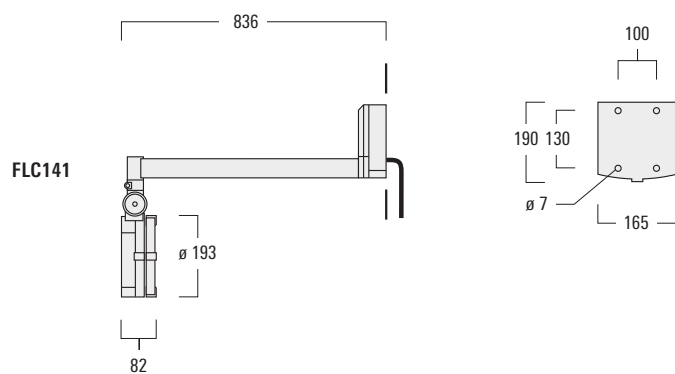
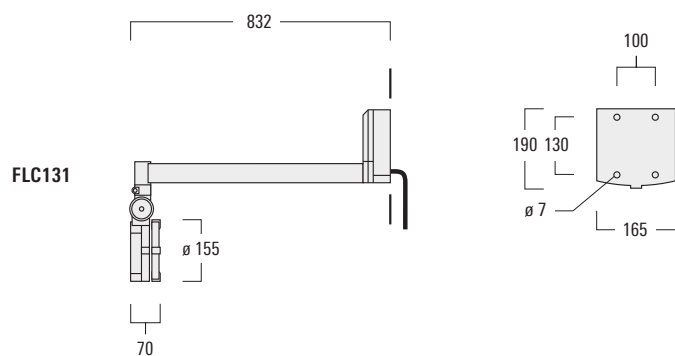
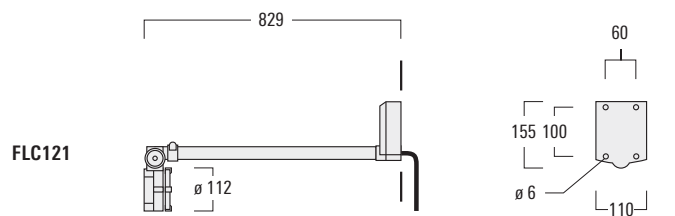

[B] [M] [EE] [EES]

* Nominal lumen output based on LED manufacturers data at 85°C T_J. For rated lumens at 25°C T_q and latest data refer to www.we-ef.com.
 ** Multiplier for Isolux value

FLC100 SERIES

Projector, wide, medium, very narrow beam or very narrow beam distribution 'sharp cut-off', symmetric.

IP66, Class I. IK07. Marine-grade die-cast aluminium alloy. 5CE superior corrosion protection including PCS hardware. Powdercoat finish in RAL 9004, RAL 9006, RAL 9007 or RAL 9016. Silicone rubber gasket. Safety glass.

Integral EC electronic converter in thermally separated compartment.

Factory installed LED circuit board. LED boards can be easily removed for upgrading. PMMA LED lens array.

Light source

LED 12-48 W, 3000 K,
for 4000 K refer to www.we-ef.com

Light distributions

[B] [M] [EE] [EES]

Accessories

- Mounting, page 294
- Optical, page 296

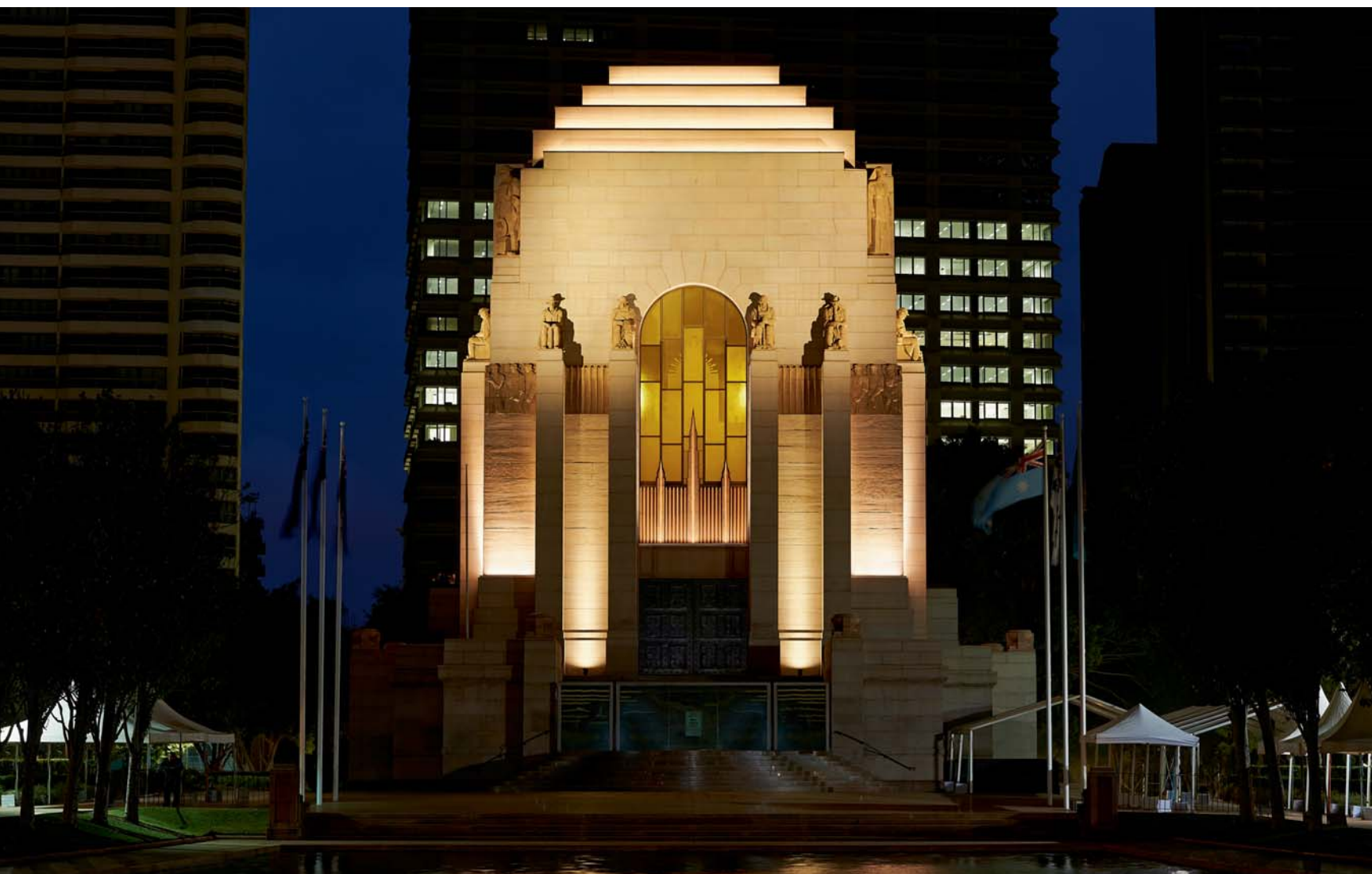

ANZAC War Memorial. Sydney (AUS). Lighting Design: Point of View.

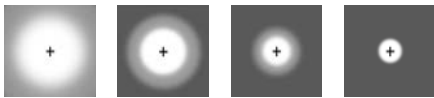

[B] [M] [EE] [EES]

- [B] Wide beam distribution, symmetric
- [M] Medium beam distribution, symmetric
- [EE] Very narrow beam distribution, symmetric
- [EES] Very narrow beam distribution, symmetric, 'sharp cut-off'



[B]	Part ID	Light source	K	lm*	cd/klm	C ₀ C ₁₈₀	kg
FLC121	145-0052	6 LED 12W / 700 mA	3000	1476	934	25°/25°	1.7
FLC131	146-0494	12 LED 24W / 700 mA	3000	2951	920	25°/25°	2.5
FLC141	146-7062	24 LED 48W / 700 mA	3000	5903	934	25°/25°	4.4

[M]	Part ID	Light source	K	lm*	cd/klm	C ₀ C ₁₈₀	kg
FLC121	145-0031	6 LED 12W / 700 mA	3000	1476	2196	16°/16°	1.7
FLC131	146-0399	12 LED 24W / 700 mA	3000	2951	2196	16°/16°	2.5
FLC141	146-7050	24 LED 48W / 700 mA	3000	5903	2196	16°/16°	4.4

[EE]	Part ID	Light source	K	lm*	cd/klm	C ₀ C ₁₈₀	kg
FLC121	145-0055	6 LED 12W / 700 mA	3000	1476	7207	7°/7°	1.7
FLC131	146-0497	12 LED 24W / 700 mA	3000	2951	7191	7°/7°	2.5
FLC141	146-7064	24 LED 48W / 700 mA	3000	5903	7207	7°/7°	4.4

[EES]	Part ID	Light source	K	lm*	cd/klm	C ₀ C ₁₈₀	kg
FLC121	145-0034	6 LED 12W / 700 mA	3000	1476	22108	5°/5°	1.7
FLC131	146-0402	12 LED 24W / 700 mA	3000	2951	20389	5°/5°	2.5
FLC141	146-7052	24 LED 48W / 700 mA	3000	5903	22108	5°/5°	4.4

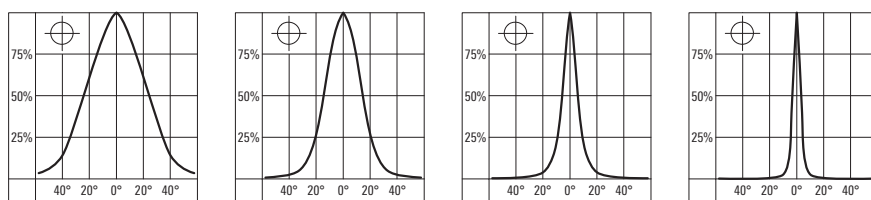
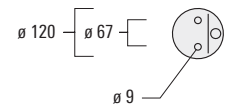
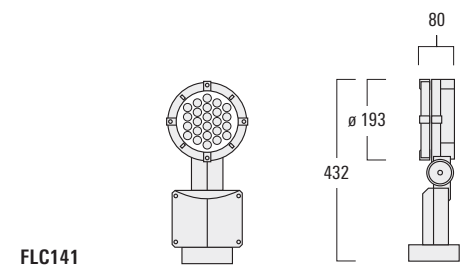
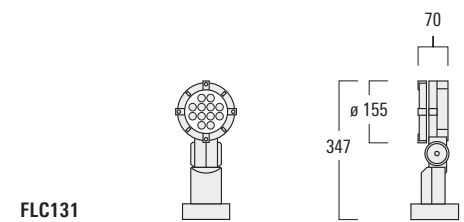
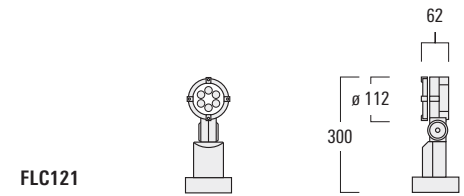

[B] [M] [EE] [EES]

* Nominal lumen output based on LED manufacturers data at 85°C T_j. For rated lumens at 25°C T_q and latest data refer to www.we-ef.com.

FLC100 SERIES

Projector, wide, medium or very narrow beam distribution, symmetric.

IP66, Class I, IK07. Marine-grade die-cast aluminium alloy. 5CE superior corrosion protection including PCS hardware. Powdercoat finish in RAL 9004, RAL 9006, RAL 9007 or RAL 9016. Silicone rubber gasket. Safety glass lens. Anodised aluminium reflector.

Integral electronic transformer for low voltage lamps, or ECG control gear for discharge lamps, in thermally separated compartment.

Light source

QT 65 W

HIT 20-150 W

Light distributions

[B] [M] [EE]

Accessories

■ Mounting, page 294

■ Optical, page 296

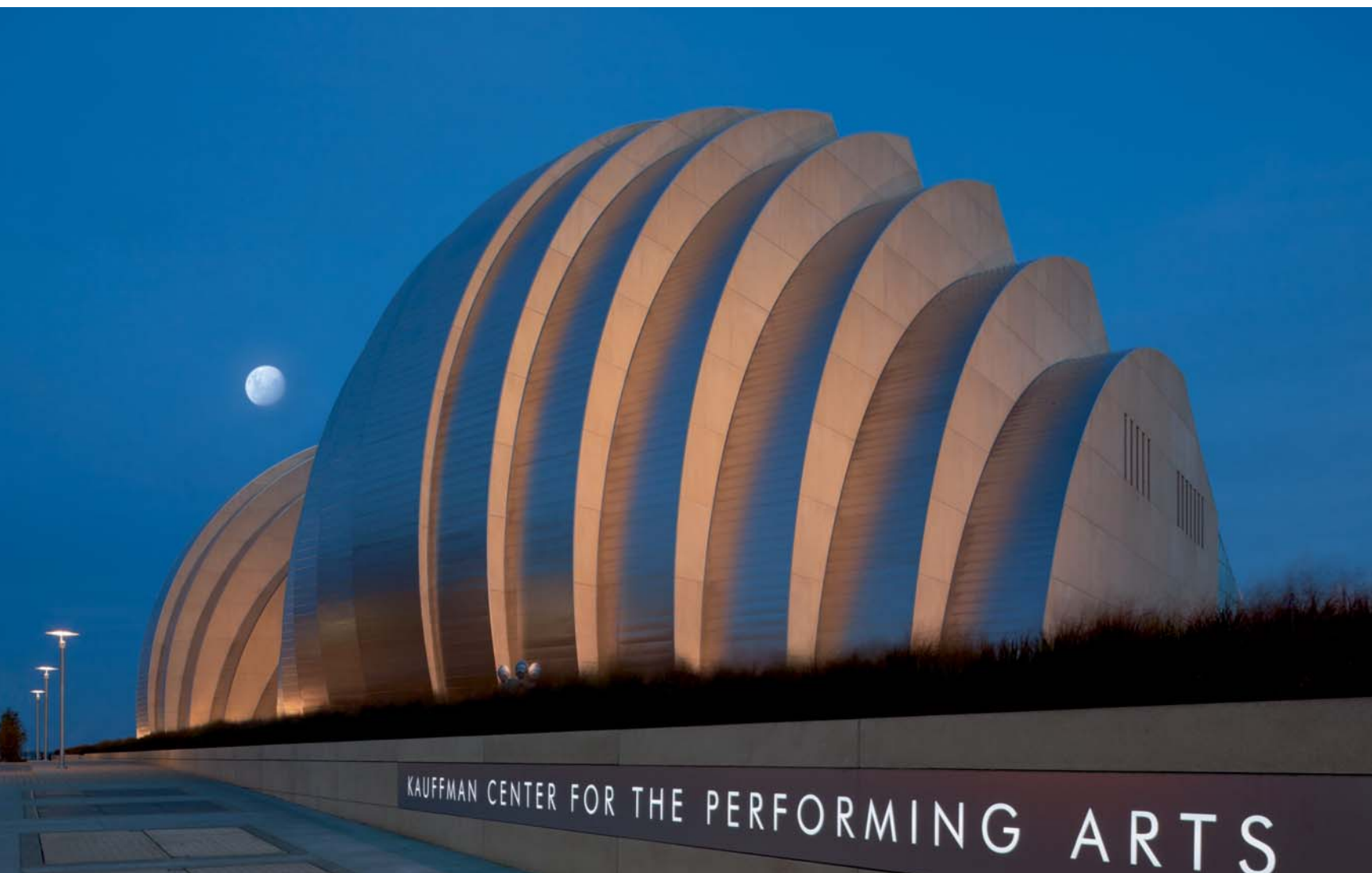

Kauffman Center for the Performing Arts. Kansas City (USA). Architect: Safdie Architects with BNIM. Lighting Designer: Lam Partners and Derek Porter Studio.



[B] [M] [EE]

[B] Wide beam distribution, symmetric
 [M] Medium beam distribution, symmetric
 [EE] Very narrow beam distribution, symmetric



[B]	Part ID	Light source	lm	cd/klm	C ₀ C ₁₈₀	kg
FLC121	145-9073 [ET]	QT 12 (-LP) ax 65W/c GY6.35/12V	1700	259	32°/32°	1.8
	145-9075 [ECG]	HIT-TC-CE 20W PGJ5	1650	504	30°/30°	1.8
	145-9077 [ECG]	HIT-TC-CE 35W PGJ5	3000	478	30°/30°	1.8

[M]	Part ID	Light source	lm	cd/klm	C ₀ C ₁₈₀	kg
FLC121	145-9002 [ET]	QT 12 (-LP) ax 65W/c GY6.35/12V	1700	1156	14°/14°	1.8
	145-9004 [ECG]	HIT-TC-CE 20W PGJ5	1650	1810	15°/15°	1.8
	145-9006 [ECG]	HIT-TC-CE 35W PGJ5	3000	1771	15°/15°	1.8
FLC131	146-0113 [ECG]	HIT-CE 35W G12	3600	1392	17°/17°	3.6
	146-0117 [ECG]	HIT-CE 70W G12	7300	1296	17°/17°	3.6
FLC141	146-0184 [ECG]	HIT-CE 150W G12	15000	1361	18°/18°	5.7

[EE]	Part ID	Light source	lm	cd/klm	C ₀ C ₁₈₀	kg
FLC121	145-9012 [ET]	QT 12 (-LP) ax 65W/c GY6.35/12V	1700	5517	5°/5°	1.8
	145-9014 [ECG]	HIT-TC-CE 20W PGJ5	1650	10995	5°/5°	1.8
	145-9016 [ECG]	HIT-TC-CE 35W PGJ5	3000	8581	5°/5°	1.8
FLC131	146-0129 [ECG]	HIT-CE 35WG12	3600	12741	4°/4°	3.6
	146-0133 [ECG]	HIT-CE 70WG12	7300	7479	4°/4°	3.6
FLC141	146-0200 [ECG]	HIT-CE 150WG12	15000	7146	4°/4°	5.7

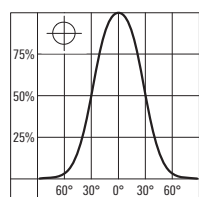

[B]

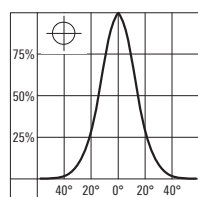

[M]

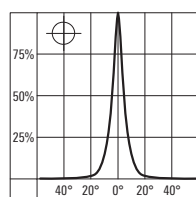

[EE]

FLC121

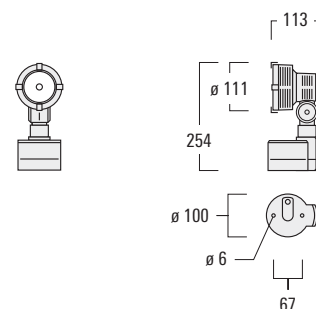

FLC131

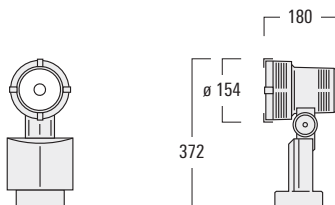

FLC141

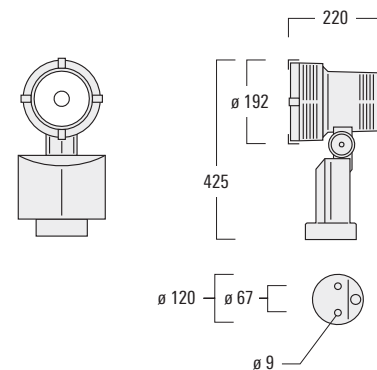

MOUNTING ACCESSORIES – FLC100 SERIES

Marine-grade aluminium construction. 5CE superior corrosion protection including PCS hardware. Powdercoat finish in RAL 9004, RAL 9006, RAL 9007 or RAL 9016.

Short post				kg
for FLC121	145-9200	EM1-2/M5	Short post	1.1
for FLC131 / 141	146-0253	EM1-2/M8	Short post	1.1

Matching planted root to be ordered separately:

Planted root for short post				kg
for FLC100 Series	300-0461	ESV4	Planted root	4.4

Galvanised steel

Ground spike				kg
for FLC121	145-9196	EF1-2/M5	Ground spike	0.4
for FLC131 / 141	146-0251	EF1-2/M8	Ground spike	0.4

Stainless steel, including 5 m of flexible cable and plug

Pipe clamps				D	kg
for FLC100 Series	146-0245	SP1-2/M8	Pipe clamp	38-60	1.0
	146-0246	SP1-2/M8	Pipe clamp	76-89	1.2
	146-0247	SP2-2/M8	Pipe clamp	38-60	1.0
	146-0248	SP2-2/M8	Pipe clamp	76-89	1.2

Wall mounted junction box				kg
for FLC131 / 141	310-9000	JB1-2/M8	Wall mounted junction box	1.6

For surface mounted cable

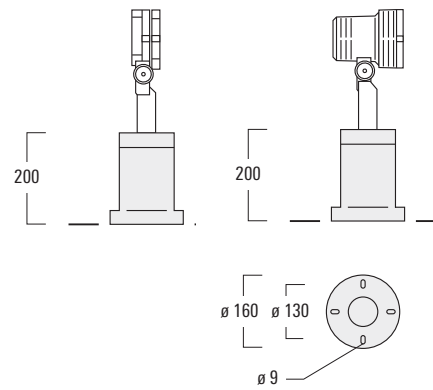

Short post EM1

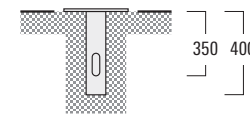

Planted root ESV4

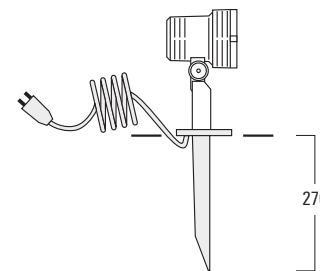

Ground spike EF1

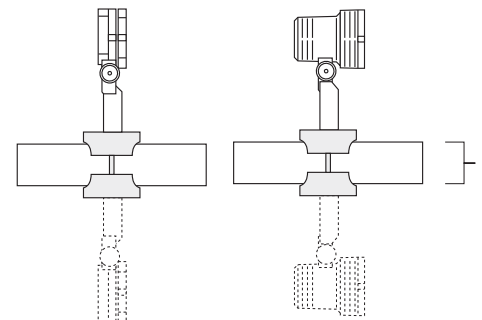

Pipe clamps SP1/SP2

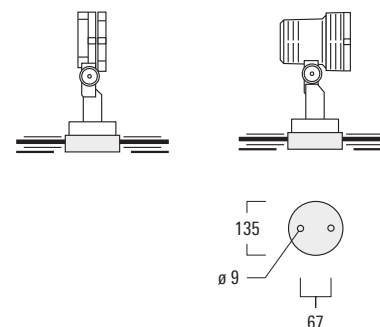

Junction box JB1



Serpentine Pavilion 2010. London (UK). Architect: Jean Nouvel, Paris. Lighting design: Arup Lighting, London.

OPTICAL ACCESSORIES – FLC100 SERIES



Internal Accessories

A maximum of one internal optical accessory.

Flood lens IO-360

for FLC121	145-0142
for FLC131	146-0623
for FLC141	146-0624

Linear spread lens IO-180

for FLC121	145-0050
for FLC131	146-0418
for FLC141	146-0439

Wallwash lens IO-20*

for FLC121 [M]	145-0145
for FLC131 [M]	146-0645
for FLC141 [M]	146-0646

Honeycomb louvre IW**

for FLC121	145-0143
for FLC131	146-0625
for FLC141	146-0626

* ideal for uniform wall washing applications

** not for [B] version

External Accessories

A maximum of one external optical accessory.

Wire guard EG

for FLC121	145-9190
for FLC131	146-0158
for FLC141	146-0231

Glare shield ES

for FLC121	145-9192
for FLC131	146-0156
for FLC141	146-0229

Snoot ET

for FLC121	145-0030
for FLC131	146-0397
for FLC141	146-0398

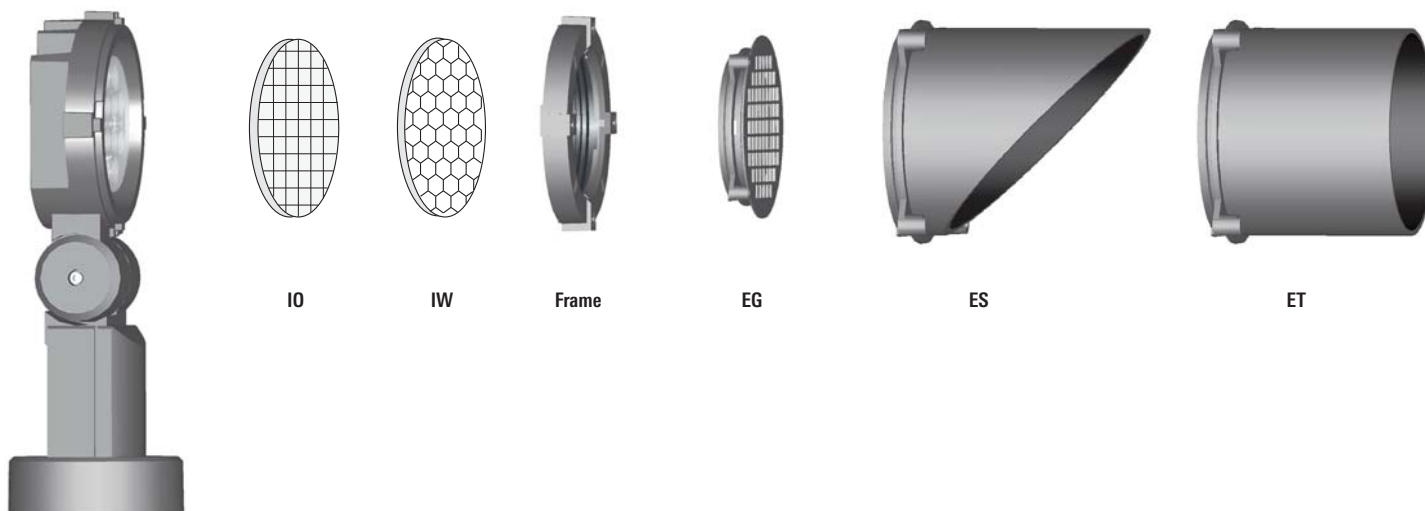

IO

IW

Frame

EG

ES

ET

OPTICAL ACCESSORIES – FLC100 SERIES

Internal Accessories

A maximum of two internal optical accessories.

Flood lens IO-360

for FLC121	145-9174
for FLC131	146-0258
for FLC141	146-0122

Linear spread lens IO-180

for FLC121	145-9172
for FLC131	146-0257
for FLC141	146-0123

Colour filter IF	red	green	blue	yellow
for FLC121	145-9176	145-9178	145-9180	145-9182
for FLC131	146-0262	146-0260	146-0259	146-0261
for FLC141	146-0141	146-0135	146-0119	146-0138

Source shield IQ

for FLC121 [EE]	145-9170
for FLC131 [EE]	146-0263
for FLC141 [EE]	146-0264

External Accessories

A maximum of one external optical accessory.

Wire guard EG

for FLC121	145-9190
for FLC131	146-0158
for FLC141	146-0231

Glare shield ES

for FLC121	145-9192
for FLC131	146-0156
for FLC141	146-0229

Snoot ET

for FLC121	145-9194
for FLC131	146-0157
for FLC141	146-0230

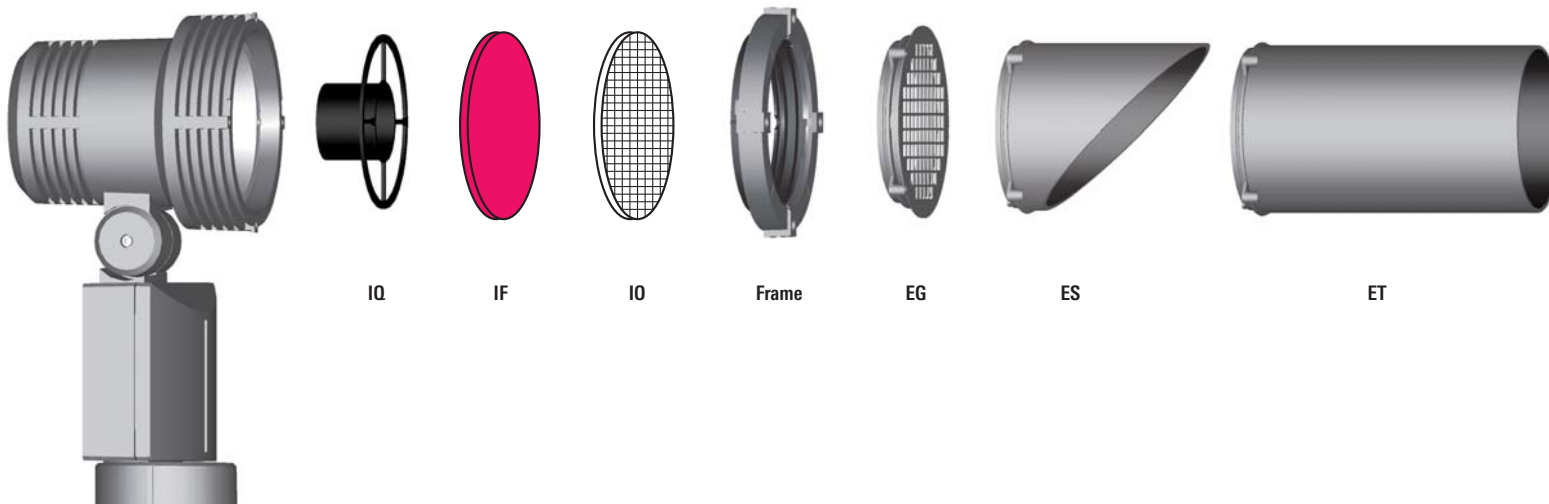

FLD100 SERIES

Projector, wide, medium, very narrow beam or very narrow beam distribution 'sharp cut-off', symmetric.

IP66, Class I. IK07. Marine-grade die-cast aluminium alloy. 5CE superior corrosion protection including PCS hardware. Powdercoat finish in RAL 9004, RAL 9006, RAL 9007 or RAL 9016. Silicone rubber gasket. Safety glass.

Integral EC electronic converter.

Factory installed LED circuit board. LED boards can be easily removed for upgrading. PMMA LED lens array.

Light source

LED 6-24 W, 3000 K,
for 4000 K refer to www.we-ef.com



Light distributions

[B] [M] [EE] [EES]

Accessories

- Mounting, page 300
- Optical, page 301



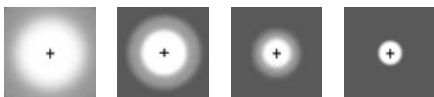

[B] [M] [EE] [EES]

[B] Wide beam distribution, symmetric

[M] Medium beam distribution, symmetric

[EE] Very narrow beam distribution, symmetric

[EES] Very narrow beam distribution, symmetric, 'sharp cut-off'



[B]	Part ID	Light source	K	lm*	cd/klm	C ₀ C ₁₈₀	kg
FLD121	145-9502	6 LED 12W / 700 mA	3000	1476	986	23°/23°	2.6
FLD131	145-9604	12 LED 24W / 700 mA	3000	2951	986	23°/23°	3.0

[M]	Part ID	Light source	K	lm*	cd/klm	C ₀ C ₁₈₀	kg
FLD111	145-9791	3 LED 6W / 700 mA	3000	738	1633	21°/21°	2.4
FLD121	145-9500	6 LED 12W / 700 mA	3000	1476	2261	17°/17°	2.6
FLD131	145-9549	12 LED 24W / 700 mA	3000	2951	2261	17°/17°	3.0

[EE]	Part ID	Light source	K	lm*	cd/klm	C ₀ C ₁₈₀	kg
FLD111	145-9792	3 LED 6W / 700 mA	3000	738	7530	7°/7°	2.4
FLD121	145-9504	6 LED 12W / 700 mA	3000	1476	7524	7°/7°	2.6
FLD131	145-9550	12 LED 24W / 700 mA	3000	2951	7524	7°/7°	3.0

[EES]	Part ID	Light source	K	lm*	cd/klm	C ₀ C ₁₈₀	kg
FLD111	145-9793	3 LED 6W / 700 mA	3000	738	16462	5°/5°	2.4
FLD121	145-9506	6 LED 12W / 700 mA	3000	1476	19392	5°/5°	2.6
FLD131	145-9605	12 LED 24W / 700 mA	3000	2951	19392	5°/5°	3.0

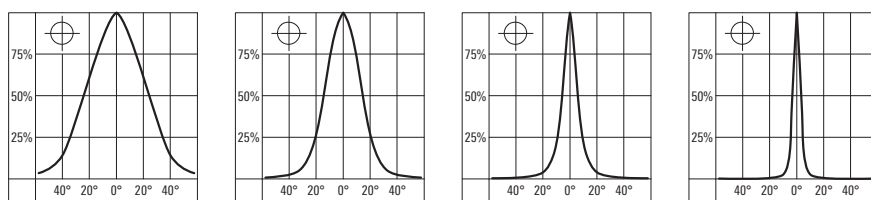
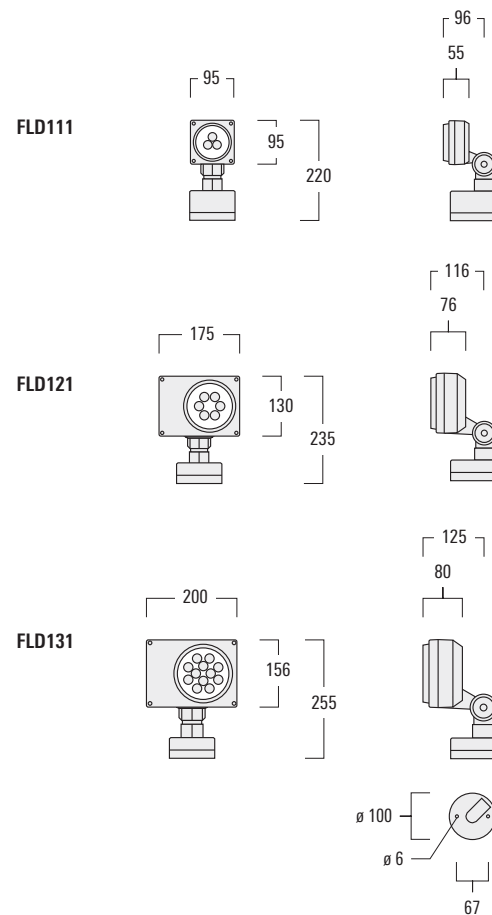

[B] [M] [EE] [EES]

* Nominal lumen output based on LED manufacturers data at 85°C T_j. For rated lumens at 25°C T_q and latest data refer to www.we-ef.com.

MOUNTING ACCESSORIES – FLD100 SERIES

Marine-grade aluminium construction. 5CE superior corrosion protection including PCS hardware. Powdercoat finish in RAL 9004, RAL 9006, RAL 9007 or RAL 9016.

Short post kg

for FLD100 Series	145-9200	EM1-2/M5	Short post	1.1
-------------------	----------	----------	------------	-----

Matching planted root to be ordered separately:

Planted root for short post kg

for FLD100 Series	300-0461	ESV4	Planted root	4.4
-------------------	----------	------	--------------	-----

galvanised steel

Ground spike kg

for FLD100 Series	145-9196	EF1-2/M5	Ground spike	0.4
-------------------	----------	----------	--------------	-----

Stainless steel, including 5 m of flexible cable and plug

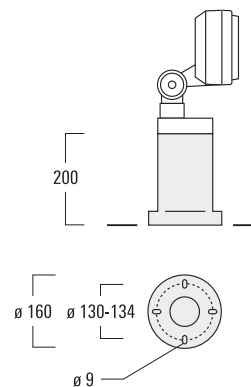

Short Post EM1

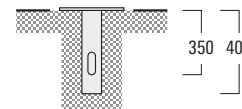

Planted root ESV4

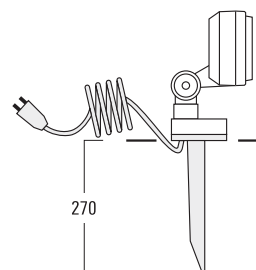

Ground Spike EF1

OPTICAL ACCESSORIES – FLD100 SERIES



Internal Accessories

Wallwash lens IO-20*

for FLD111 [M]	145-9846
for FLD121 [M]	145-9479
for FLD131 [M]	145-9577

* ideal for uniform wall washing applications, factory fitted only.

External Accessories

A maximum of two external optical accessories. If a flood or spread lens is used as a 'stand alone' accessory, an optical adaptor is required – to be ordered separately.

Optical adaptor

for FLD111	145-9830
for FLD121	145-9530
for FLD131	145-9570

Flood lens EO-360

for FLD111	145-9834
for FLD121	145-9534
for FLD131	145-9574

Linear spread lens EO-180

for FLD111	145-9833
for FLD121	145-9533
for FLD131	145-9573

Glare shield ES

for FLD111	145-9831
for FLD121	145-9531
for FLD131	145-9571

Snoot ET

for FLD111	145-9832
for FLD121	145-9532
for FLD131	145-9572

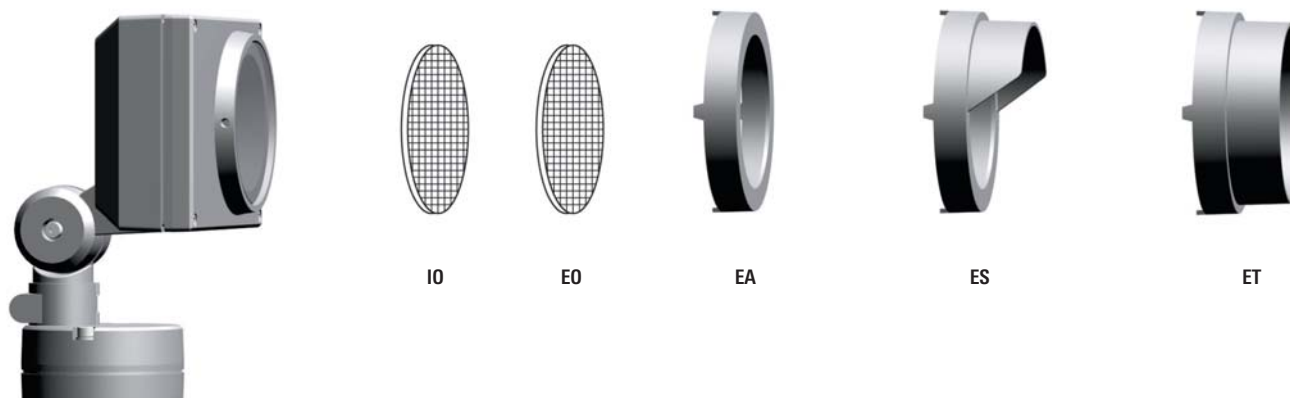

FLC200 SERIES

Projector, medium, very narrow beam or very narrow beam distribution 'sharp cut-off', symmetric.

IP66, Class III. Without electronic converter.

IP66, Class I. With electronic converter.

IK09. Marine-grade die-cast aluminium. 5CE superior corrosion protection including PCS hardware. Powdercoat finish in RAL 9004, RAL 9006, RAL 9007 or RAL 9016.

Silicone rubber gasket. Safety glass lens.

Factory installed LED circuit board. LED boards can be easily removed for upgrading. PMMA LED lens array.

Electronic converter required. To be ordered separately (for version without electronic converter).

Option available: ground spike made from stainless steel with 5m flexible cable and plug.

Light source

LED 2-3 W, 3000 K,
for 4000 K refer to www.we-ef.com

Light distributions

[M] [EE] [EES]

Accessories

- Mounting, page 322
- Optical, page 324

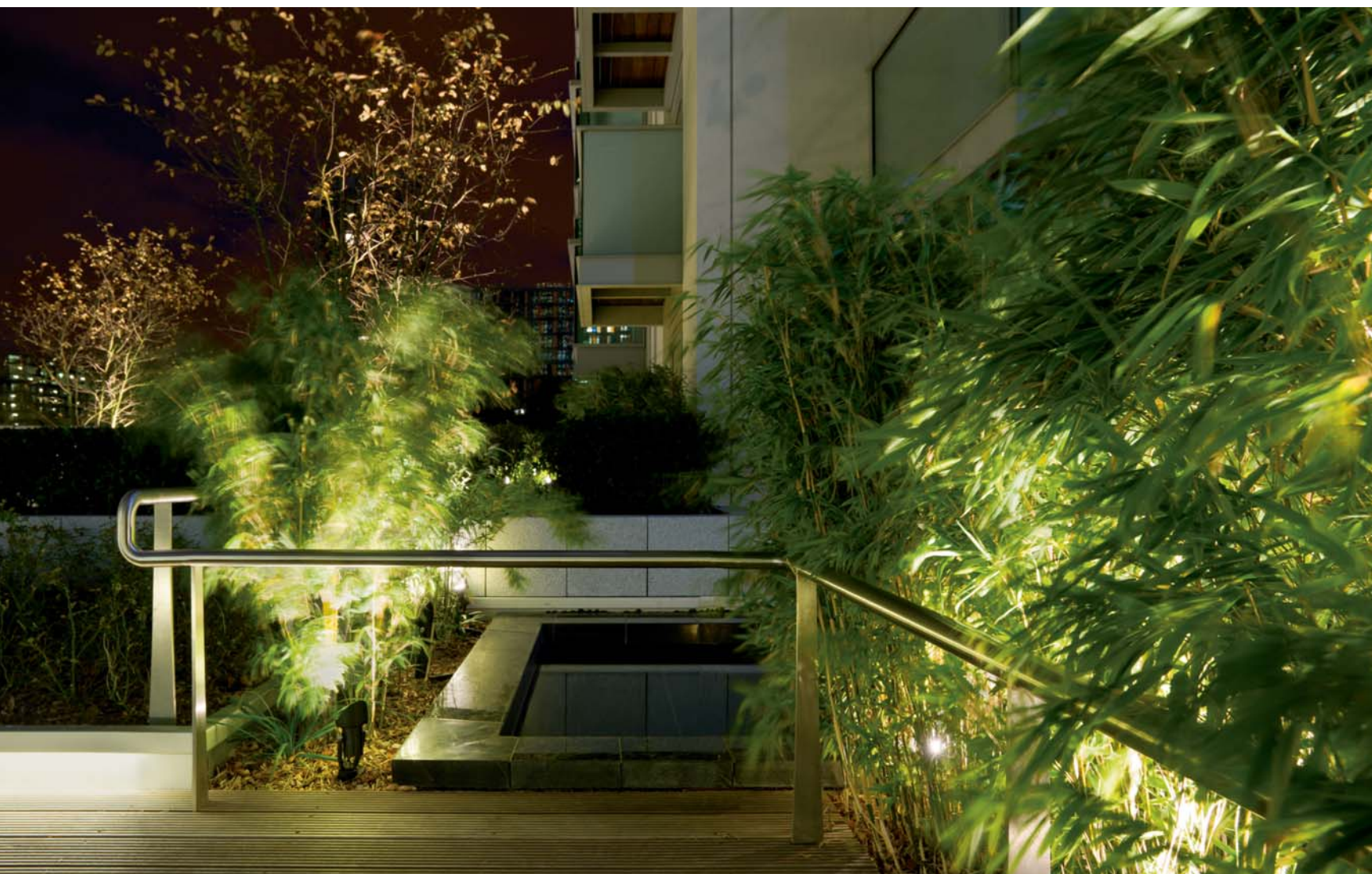



[M] [EE] [EES]

[M] Medium beam distribution, symmetric

[EE] Very narrow beam distribution, symmetric

[EES] Very narrow beam distribution, symmetric, 'sharp cut-off'



without electronic converter



with electronic converter

[M]	Part ID	Light source	K	lm*	cd/klm	C ₀ C ₁₈₀	kg
FLC210	139-1641	3 LED 3W / 24V AC/DC	3000	404	1552	21°/21°	0.9
	139-1565	1 LED 2W / 24V AC/DC	3000	200	2119	16°/16°	0.9
FLC210**	139-1650	3 LED 3W / 230V	3000	404	1552	21°/21°	1.1
	139-1450	1 LED 2W / 230V	3000	200	2119	16°/16°	1.1

[EE]	Part ID	Light source	K	lm*	cd/klm	C ₀ C ₁₈₀	kg
FLC210	139-1642	3 LED 3W / 24V AC/DC	3000	404	7076	7°/7°	0.9
FLC210**	139-1652	3 LED 3W / 230V	3000	404	7076	7°/7°	1.1

[EES]	Part ID	Light source	K	lm*	cd/klm	C ₀ C ₁₈₀	kg
FLC210	139-1643	3 LED 3W / 24V AC/DC	3000	404	11915	6°/6°	0.9
	139-1671	1 LED 2W / 24V AC/DC	3000	200	29000	4°/4°	0.9
FLC210**	139-1654	3 LED 3W / 230V	3000	404	11915	6°/6°	1.1
	139-1673	1 LED 2W / 230V	3000	200	29000	4°/4°	1.1

** with electronic converter

Mains converter (230V / 24V DC)

IP20, Class I. Mounting to 35 mm rail.	A	B	C
for FLC210 400-0310 TVE-DC 24 V/12 W	90	18	61
400-0311 TVE-DC 24 V/60 W	89	72	59

Magnetic transformer (230V / 24V AC)

IP65, Class II.	A	B	C
for FLC210 185-2884 TVM-AC 24 V/20 W	40	65	90
185-2885 TVM-AC 24 V/50 W	140	65	90

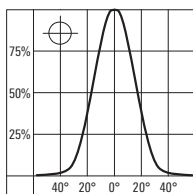

[M]

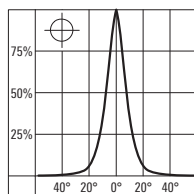

[EE]

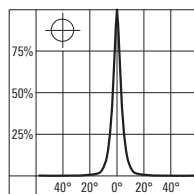

[EES]

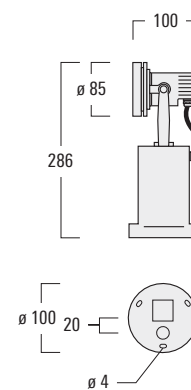
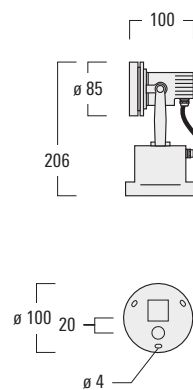

* Nominal lumen output based on LED manufacturers data at 85°C T_J. For rated lumens at 25°C T_q and latest data refer to www.we-ef.com.

FLC200 SERIES

Projector, medium, very narrow beam or very narrow beam distribution 'sharp cut-off', symmetric.

IP66, Class I. IK07. Marine-grade die-cast aluminium alloy. 5CE superior corrosion protection including PCS hardware. Powdercoat finish in RAL 9004, RAL 9006, RAL 9007 or RAL 9016. Silicone rubber gasket. Safety glass lens, hinged. One cable gland. Second gland for through wiring on request.

EC electronic converter.

Factory installed LED circuit board. LED boards can be easily removed for upgrading. PMMA LED lenses.

Optional 1-10V or DALI interface on request.

Light source

LED 24-155 W, 3000 K,
for 4000 K refer to www.we-ef.com

Light distributions

[M] [EE] [EES]

Accessories

- Mounting, page 322
- Optical, page 324



The Goods Line at Ultimo. Sydney (AUS) Lighting Design: Lighting, Art + Science. Landscape Architects: Aspect Studios / CHROFI

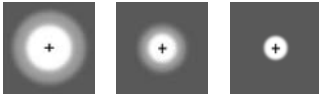

[M] [EE] [EES]

[M] Medium beam distribution, symmetric

[EE] Very narrow beam distribution, symmetric

[EES] Very narrow beam distribution, symmetric, 'sharp cut-off'



[M]	Part ID	Light source	K	lm*	cd/klm	C ₀ C ₁₈₀	kg
FLC230	139-1830	12 LED 24W / 700 mA	3000	3257	2829	15°/15°	7.6
	139-1836	12 LED 36W / 1050 mA	3000	4680	2829	15°/15°	7.6
	139-1842	12 LED 52W / 1400 mA	3000	5986	2829	15°/15°	7.6
FLC240	139-1812	24 LED 48W / 700 mA	3000	6515	2829	15°/15°	12.6
	139-1818	24 LED 72W / 1050 mA	3000	9360	2829	15°/15°	12.6
	139-1824	24 LED 104W / 1400 mA	3000	11971	2829	15°/15°	12.6
FLC260	139-1806	36 LED 72W / 700 mA	3000	9772	2829	15°/15°	18.8
	139-1791	36 LED 108W / 1050 mA	3000	14040	2829	15°/15°	18.8
	139-1797	36 LED 155W / 1400 mA	3000	17957	2829	15°/15°	18.8

[EE]	Part ID	Light source	K	lm*	cd/klm	C ₀ C ₁₈₀	kg
FLC230	139-1832	12 LED 24W / 700 mA	3000	3257	10951	7°/7°	7.6
	139-1838	12 LED 36W / 1050 mA	3000	4680	10951	7°/7°	7.6
	139-1844	12 LED 52W / 1400 mA	3000	5986	10951	7°/7°	7.6
FLC240	139-1814	24 LED 48W / 700 mA	3000	6515	10951	7°/7°	12.6
	139-1820	24 LED 72W / 1050 mA	3000	9360	10951	7°/7°	12.6
	139-1826	24 LED 104W / 1400 mA	3000	11971	10951	7°/7°	12.6
FLC260	139-1808	36 LED 72W / 700 mA	3000	9772	10951	7°/7°	18.8
	139-1793	36 LED 108W / 1050 mA	3000	14040	10951	7°/7°	18.8
	139-1799	36 LED 155W / 1400 mA	3000	17957	10951	7°/7°	18.8

[EES]	Part ID	Light source	K	lm*	cd/klm	C ₀ C ₁₈₀	kg
FLC230	139-1834	12 LED 24W / 700 mA	3000	3257	27474	4°/4°	9.1
	139-1840	12 LED 36W / 1050 mA	3000	4680	27474	4°/4°	9.1
	139-1846	12 LED 52W / 1400 mA	3000	5986	27474	4°/4°	9.1
FLC240	139-1816	24 LED 48W / 700 mA	3000	6515	27474	4°/4°	14.7
	139-1822	24 LED 72W / 1050 mA	3000	9360	27474	4°/4°	14.7
	139-1828	24 LED 104W / 1400 mA	3000	11971	27474	4°/4°	14.7
FLC260	139-1810	36 LED 72W / 700 mA	3000	9772	27474	4°/4°	18.8
	139-1795	36 LED 108W / 1050 mA	3000	14040	27474	4°/4°	18.8
	139-1801	36 LED 155W / 1400 mA	3000	17957	27474	4°/4°	18.8

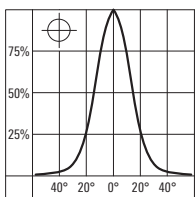

[M]

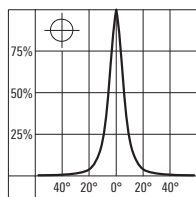

[EE]

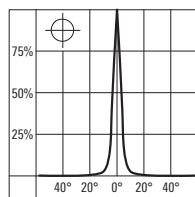

[EES]

FLC230

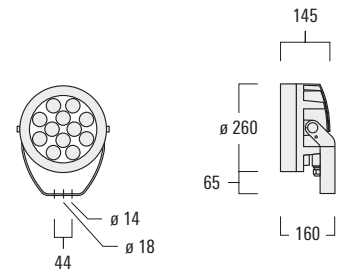

FLC240

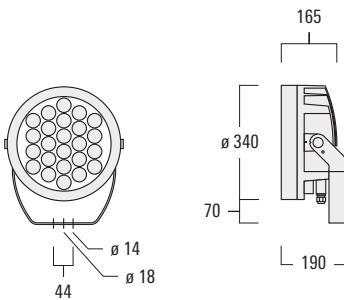

FLC260

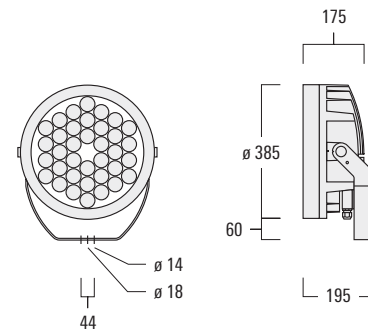

* Nominal lumen output based on LED manufacturers data at 85°C T_j. For rated lumens at 25°C T_q and latest data refer to www.we-ef.com.

FLC200 COLOUR CHANGER SERIES

RGBW Colour changer, medium or very narrow beam distribution, symmetric.

IP66, Class I. IK07. Marine-grade die-cast aluminium alloy. 5CE superior corrosion protection including PCS hardware. Powdercoat finish in RAL 9004, RAL 9006, RAL 9007 or RAL 9016. Silicone rubber gasket. Safety glass lens, hinged. One cable gland. Second gland for through wiring on request.

EC electronic converter with DMX interface. Optional DALI interface on request.

Factory installed LED circuit board. LED boards can be easily removed for upgrading. PMMA LED lenses.

Light source

LED 74 W, 3000 K,
for 4000 K refer to www.we-ef.com

Light distributions

[M] [EE]

Accessories

- Mounting, page 322
- Optical, page 324

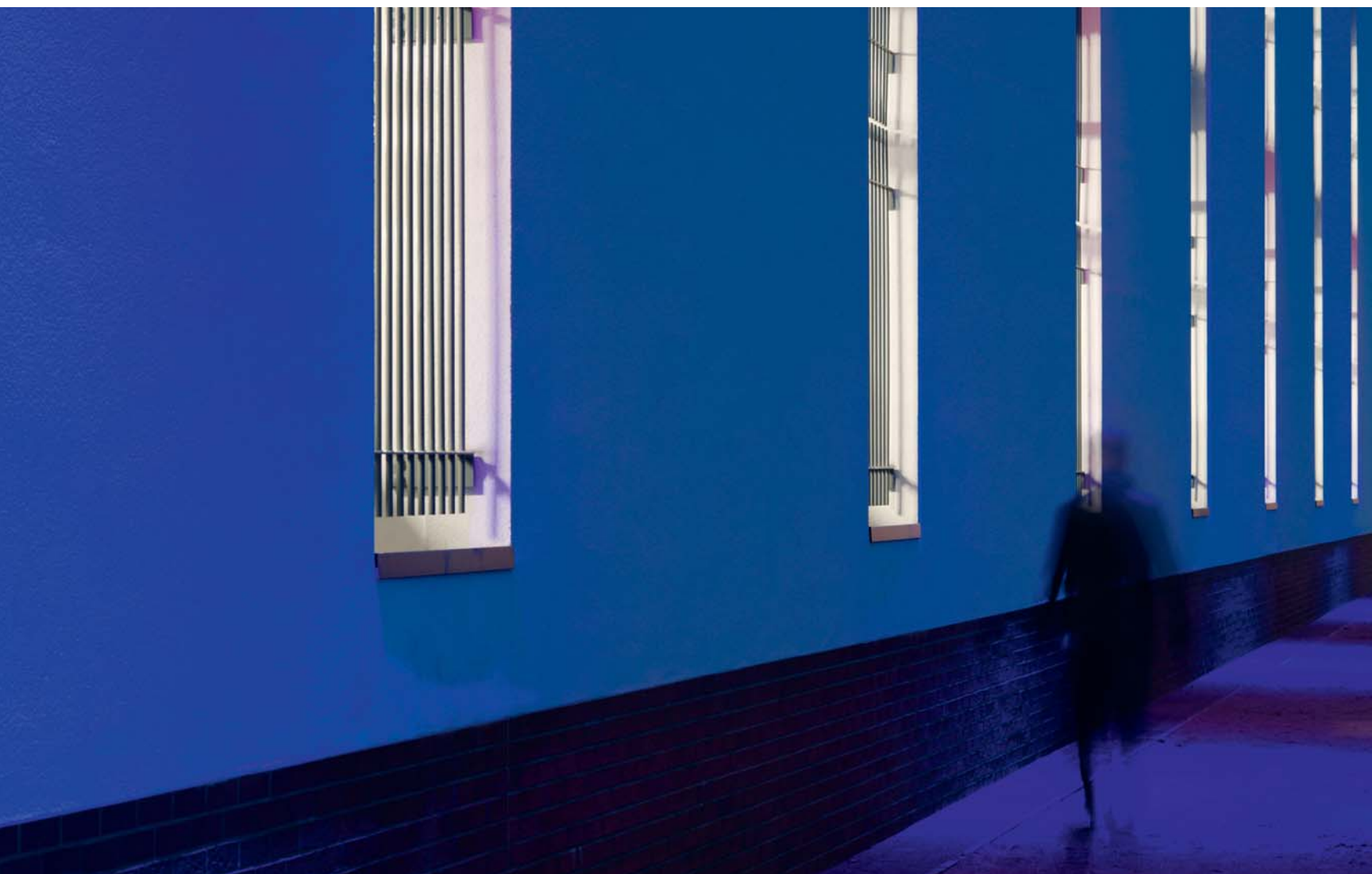



[M] [EE]

[M] Medium beam distribution, symmetric
 [EE] Very narrow beam distribution, symmetric



[M]	Part ID	Light source	lm*	cd/klm	C ₀ C ₁₈₀	kg
FLC260-CC [DMX]	139-1803	18 LED 74W / 350 mA RGBW	4295	2761	16°/16°	18.8

[EE]	Part ID	Light source	lm*	cd/klm	C ₀ C ₁₈₀	kg
FLC260-CC [DMX]	139-1804	18 LED 74W / 350 mA RGBW	4295	7804	8°/8°	18.8

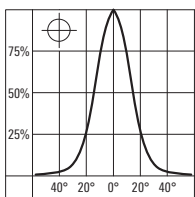
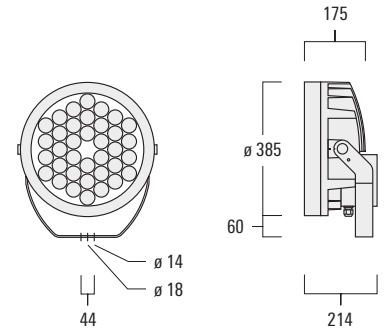

[M]

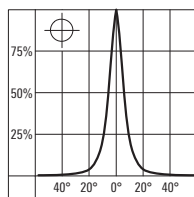

[EE]

* All channels maximum performance

FLC200 SERIES

Projector, medium or very narrow beam distribution, symmetric.

IP66, Class III. Without electronic converter.

IP66, Class I. With electronic converter or ECG control gear.

IK09. Marine-grade die-cast aluminium. 5CE superior corrosion protection including PCS hardware. Powdercoat finish in RAL 9004, RAL 9004, RAL 9006, RAL 9007 or RAL 9016. Silicone rubber gasket. Anodised aluminium reflector. Safety glass lens.

Electronic converter required. To be ordered separately (for version without electronic converter).

Option available: ground spike made from stainless steel with 5m flexible cable and plug.

Light source

QT 35 W

HIT 20-35 W

Light distributions

[M] [EE]

Accessories

■ Mounting, page 322

■ Optical, page 34



Freie Kammerspiele. Magdeburg (D). Architect: Kirchner + Przyborowski, Magdeburg. Lighting design: IPK Magdeburg GmbH, Magdeburg.

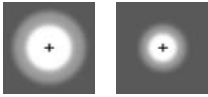

[M] [EE]

[M] Medium beam distribution, symmetric

[EE] Very narrow beam distribution, symmetric



without electronic converter



with electronic converter

[M]	Part ID	Light source	lm	cd/klm	C ₀ C ₁₈₀	kg
FLC210	139-1184	QT 12 (-LP) ax 35W/c GY6.35/12V	900	1239	13°/13°	0.9
FLC210*	139-1447 [ET]	QT 12 (-LP) ax 35W/c GY6.35/12V	900	1239	13°/13°	1.2
	139-1443 [ECG]	HIT-TC-CE 20W PGJ5	1650	806	22°/22°	1.5
	139-1445 [ECG]	HIT-TC-CE 35W PGJ5	3000	708	24°/24°	1.5

[EE]	Part ID	Light source	lm	cd/klm	C ₀ C ₁₈₀	kg
FLC210	139-1185	QT 12 (-LP) ax 35W/c GY6.35/12V	900	5328	4°/4°	0.9
FLC210*	139-1448 [ET]	QT 12 (-LP) ax 35W/c GY6.35/12V	900	5328	4°/4°	1.2
	139-1444 [ECG]	HIT-TC-CE 20W PGJ5	1650	4531	6°/6°	1.5
	139-1446 [ECG]	HIT-TC-CE 35W PGJ5	3000	3056	7°/7°	1.5

* with electronic converter

Magnetic transformer (230V / 24V)

IP65, Class II.	A	B	C	
for FLC210 185-1548	TVM-AC 12 V/50W	150	65	90

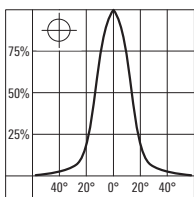
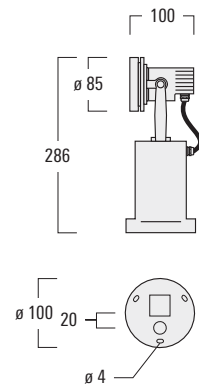
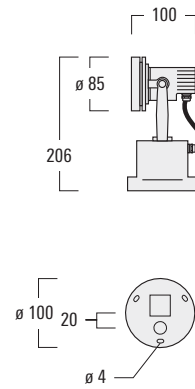

[M]

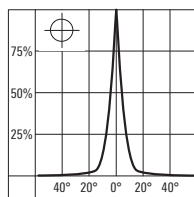

[EE]

FLC200 SERIES

Projector, medium or very narrow beam distribution, symmetric.

IP66, Class I. IK07. Marine-grade die-cast aluminium alloy. 5CE superior corrosion protection including PCS hardware. Powdercoat finish in RAL 9004, RAL 9006, RAL 9007 or RAL 9016. Silicone rubber gasket. Safety glass lens, hinged. Anodised aluminium reflector. One cable gland. Second gland for through wiring on request.

HPF or ECG control gear, thermally separated.

Light source
HIT 20-150 W

Light distributions
[M] [EE]

Accessories

■ Mounting, page 322

■ Optical, page 324



Otto place. Train Station Messe Köln-Deutz (D). Planning: BBZL Boehm Benfer Zahiri, Berlin. Facade lighting: Gerhard Kleiker, RheinEnergie AG, Köln.



[M] [EE]

[M] Medium beam distribution, symmetric
 [EE] Very narrow beam distribution, symmetric



20-70W [ECG] with ECG control gear
 70-150W [HPF] with HPF control gear



150W [ECG] with remote ECG control gear

[M]	Part ID	Light source	lm	cd/klm	C ₀ C ₁₈₀	kg
FLC230	139-1196 [ECG]	HIT-TC-CE 20W PGJ5	1650	1685	16°/16°	2.7
	139-1198 [ECG]	HIT-TC-CE 35W PGJ5	3000	1496	17°/17°	2.7
FLC240	139-0659 [HPF]	HIT-CE 70W G12	7300	1648	20°/20°	9.0
	139-1200 [ECG]	HIT-CE 70W G12	7300	1643	20°/20°	7.9
	139-0662 [HPF]	HIT-CE 150W G12	15000	1280	23°/23°	9.5
FLC240*	139-0793 [ECG]	HIT-CE 150W G12	15000	1280	23°/23°	8.4

[EE]	Part ID	Light source	lm	cd/klm	C ₀ C ₁₈₀	kg
FLC230	139-1197 [ECG]	HIT-TC-CE 20W PGJ5	1650	29856	3°/3°	2.7
	139-1199 [ECG]	HIT-TC-CE 35W PGJ5	3000	18240	4°/4°	2.7
FLC240	139-0671 [HPF]	HIT-CE 70W G12	7300	1648	3°/3°	9.0
	139-1201 [ECG]	HIT-CE 70W G12	7300	29929	3°/3°	7.9
	139-0674 [HPF]	HIT-CE 150W G12	15000	18752	4°/4°	9.5
FLC240*	139-0812 [ECG]	HIT-CE 150W G12	15000	18752	4°/4°	8.4

* Thermally separated control gear

FLC230

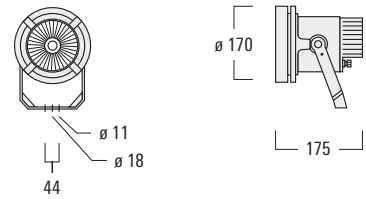

FLC240

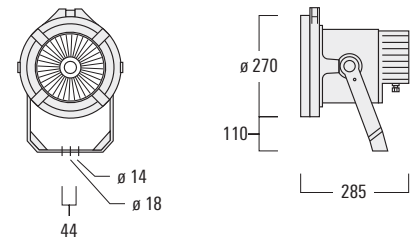

20-70W [ECG] with ECG control gear
 70-150W [HPF] with HPF control gear

FLC240

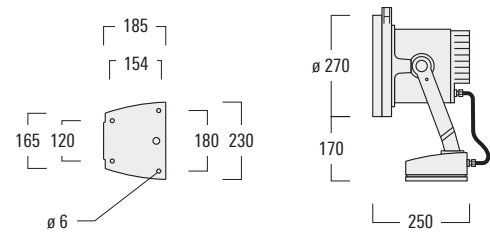

150W [ECG] with remote ECG control gear

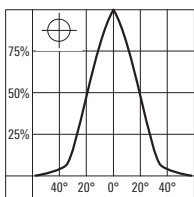

[M]

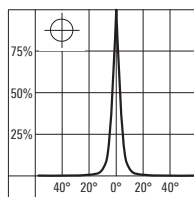

[EE]

FLC200 SERIES

Projector, medium or very narrow beam distribution, symmetric.

IP66, Class I, IK07. Marine-grade die-cast aluminium alloy. 5CE superior corrosion protection including PCS hardware. Powdercoat finish in RAL 9004, RAL 9006, RAL 9007 or RAL 9016. Silicone rubber gasket. Safety glass lens, hinged. Anodised aluminium reflector. One cable gland. Second gland for through wiring on request.

HPF control gear, thermally separated.

Light source
HIT 250-400 W

Light distributions
[M] [EE]

Accessories

- Mounting, page 322
- Electrical, page 323
- Optical, page 324

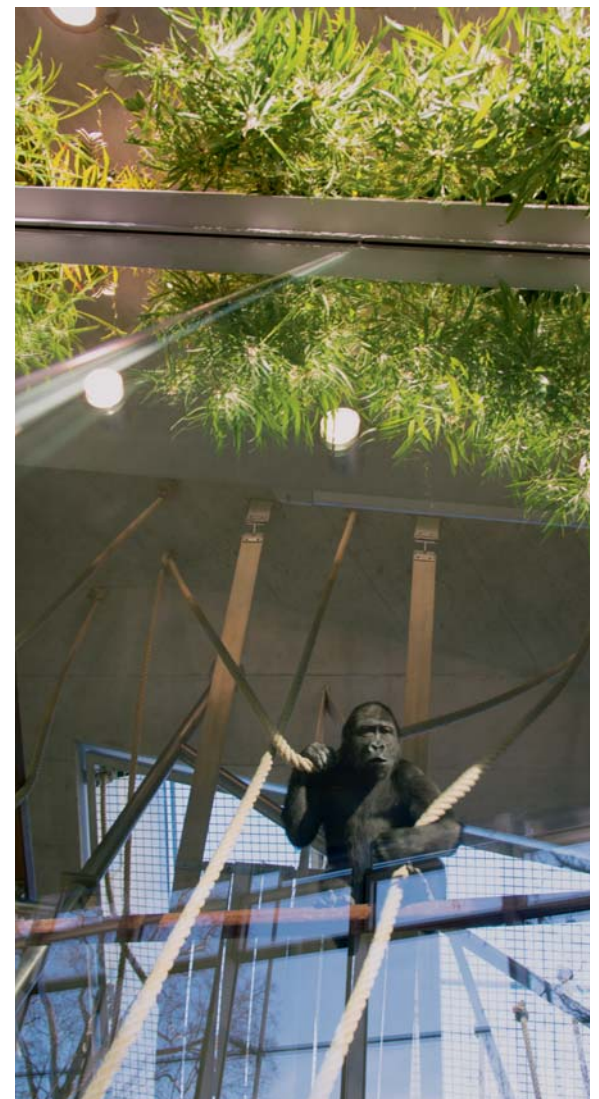
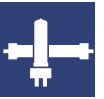

Gorilla House, Wilhelma Zoo, Stuttgart (D). Architect: Hascher Jehle Architektur, Berlin.

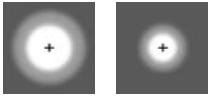

[M] [EE]

[M] Medium beam distribution, symmetric

[EE] Very narrow beam distribution, symmetric



[M]	Part ID	Light source	lm	cd/klm	C ₀ C ₁₈₀	C ₉₀ C ₂₇₀	kg
FLC250	139-0680 [HPF]	HIT-DE 250W Fc2	20000	1757	17°/17°	13°/13°	13,4
	139-0682 [HPF]	HIT-DE 400W Fc2	36000	1444	20°/20°	17°/17°	15,6

[EE]	Part ID	Light source	lm	cd/klm	C ₀ C ₁₈₀	C ₉₀ C ₂₇₀	kg
FLC250	139-0690 [HPF]	HIT-DE 250W Fc2	20000	17463	3°/3°	4°/4°	13,4
	139-0692 [HPF]	HIT-DE 400W Fc2	36000	12843	3°/3°	4°/4°	15,6

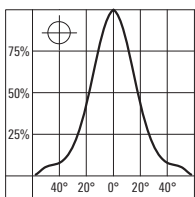
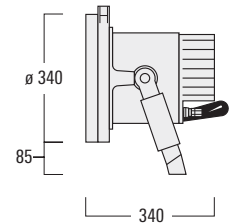
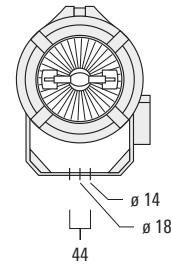

[M]

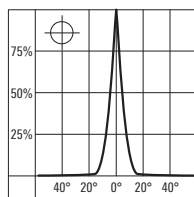

[EE]

FLC200 SERIES

Projector, medium or very narrow beam distribution, symmetric.

IP66, Class I, IK07. Marine-grade die-cast aluminium alloy. 5CE superior corrosion protection including PCS hardware. Powdercoat finish in RAL 9004, RAL 9006, RAL 9007 or RAL 9016. Silicone rubber gasket. High temperature ceramic glass with wire mesh.

Anodised aluminium reflector, hinged, with circuit breaker.

One cable gland. Second gland for through wiring on request.

Remote HPF gear box made from marine-grade die-cast aluminium alloy or in pole HPF gear tray, to be ordered separately.

Light source
HIT 1000-2000 W

Light distributions
[M] [EE]

Accessories

- Mounting, page 322
- Electrical, page 323
- Optical, page 324



The Auckland Sky Tower. Auckland (NZ). Architect: Gordon Moeller. Lighting design: Modus Lighting, Auckland.

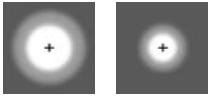

[M] [EE]

[M] Medium beam distribution, symmetric
 [EE] Very narrow beam distribution, symmetric



[M]	Part ID	Light source	lm	cd/klm	C ₀ C ₁₈₀	C ₉₀ C ₂₇₀	kg
FLC280*	139-1204 [IGN]	HIT-SA-DE 1000W K12s-36/Cable	90000	4653	4°/4°	13°/13°	17.2
	139-1205 [IGN]	HIT-SA-DE 2000W K12s-36/Cable	200000	4163	5°/5°	11°/11°	17.2

[EE]	Part ID	Light source	lm	cd/klm	C ₀ C ₁₈₀	C ₉₀ C ₂₇₀	kg
FLC280*	139-1206 [IGN]	HIT-SA-DE 1000W K12s-36/Cable	90000	10782	4°/4°	6°/6°	17.2
	139-1207 [IGN]	HIT-SA-DE 2000W K12s-36/Cable	200000	9696	4°/4°	5°/5°	17.2

* Ignitor version. Remote HPF gear box made from marine-grade die-cast aluminium alloy or in pole HPF gear tray, to be ordered separately.

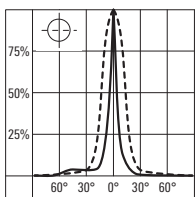
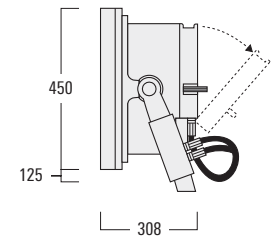
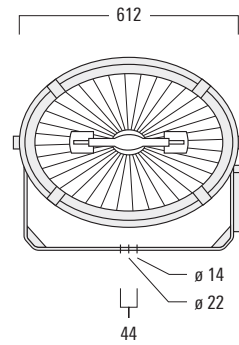

[M]

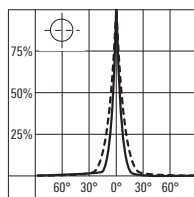

[EE]

FLC200 COLOUR CHANGER SERIES

CMY Colour changer, wide, medium or narrow beam distribution, symmetric.

IP66, Class I. IK07. Marine-grade die-cast aluminium alloy. 5CE superior corrosion protection including PCS hardware. Powdercoat finish in RAL 9004, RAL 9006, RAL 9007 or RAL 9016. Silicone rubber gasket. Safety glass lens, hinged. Anodised aluminium reflector. Integral ECG control gear.

- CMY dichroic colour filters for subtractive colour mixing
- Reset function and test program
- Storage of up to 99 scenes and 99 sequences, storage of up to 7 daily programs or 1 weekly program
- Stand alone function and master slave function
- 4 cross fading sequences
- Integrated calendar with timer function and integrated operation hour counter
- DMX in- and output and RJ45 interface
- WE-EF CONTROL® CMY-DMX PC based software supplied

Light source
HIT 150 W

Light distributions
[B] [M] [E]

Accessories

- Mounting, page 322
- Electrical, page 323
- Optical, page 324



La Croisette. Cannes (F). Lighting design: Citelum - ALC-Sogreah.

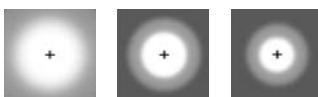

[B]

[M]

[E]

[B] Wide beam distribution, symmetric

[M] Medium beam distribution, symmetric

[E] Narrow beam distribution, symmetric



[B]	Part ID	Light source	lm	cd/klm	C ₀ C ₁₈₀	kg
FLC254-CC	139-1246 [ECG.DMX]	HIT-CE 150W G12	15000	527	29°/29°	20.5

[M]	Part ID	Light source	lm	cd/klm	C ₀ C ₁₈₀	kg
FLC254-CC	139-1181 [ECG.DMX]	HIT-CE 150W G12	15000	858	19°/19°	20.5

[E]	Part ID	Light source	lm	cd/klm	C ₀ C ₁₈₀	kg
FLC254-CC	139-1202 [ECG.DMX]	HIT-CE 150W G12	15000	2241	10°/10°	20.5

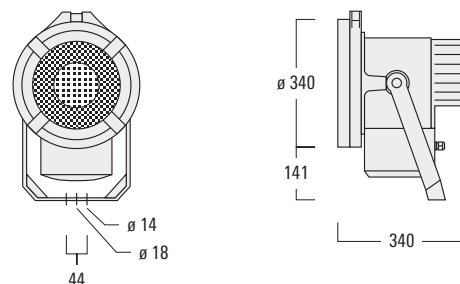

Individual programming via PC or the optional available WE-EF HH1 handheld programmer:

139-1218 [DMX] HH1 handheld programmer including RS232 serial cable

- RS232 serial cable supplied with HH1 handheld
- Storage of up to 999 scenes and 999 sequences
- Storage of up to 99 daily, weekly, monthly or special day programs
- DMX interface

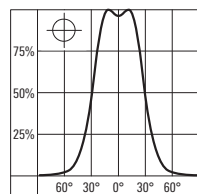

[B]

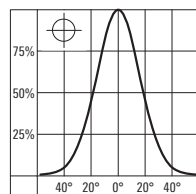

[M]

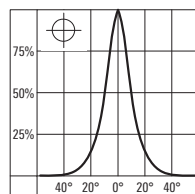

[E]

[B]

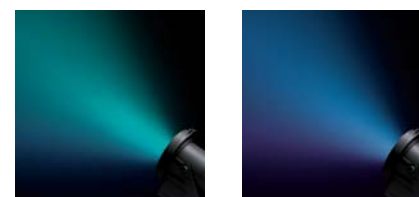

[M]

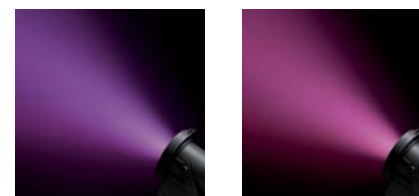

[E]

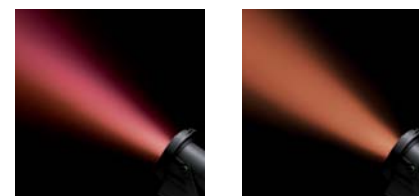

FLC200 GOBO SERIES

Projector, twin aspheric convex lens system including Profile Projector.

IP66, Class I. IK09. Marine-grade die-cast aluminium alloy. 5CE superior corrosion protection including PCS hardware. Powdercoat finish in RAL 9004, RAL 9006, RAL 9007 or RAL 9016. Silicone rubber gasket. Safety glass lens, hinged. Anodised aluminium reflector. Twin aspheric, convex lens system for spot distribution.

One cable gland. Second gland for through wiring on request.

Integral HPF control gear.

Light source

HIT 150 W

Light distribution

[BL]

Accessories

■ Mounting, page 322



Harpa Concert- and Congress hall, Reykjavik (IS). Architect: Henning Larsen Architects HLA, Copenhagen (DK) & Batteriid Architects, Hafnarfjordur (IS).
Lighting design: Hnit Verkis Consulting Engineers, Reykjavik (IS)



[BL] – ZP [BL] – GP [BL] – FP

Profile Projector for Zoom, Gobo or Framing applications

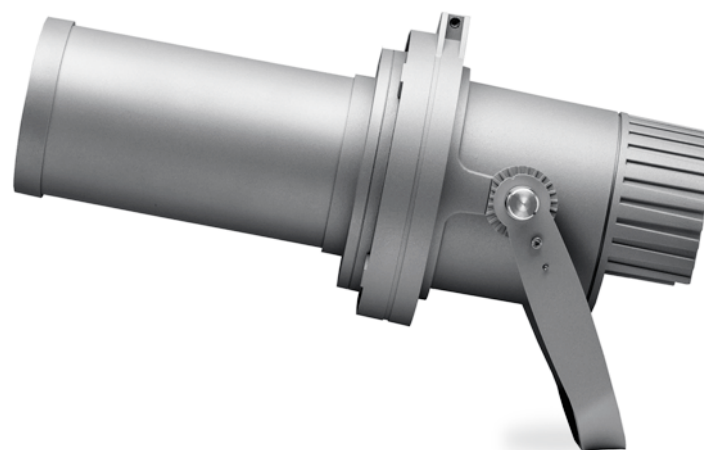

[BL] – ZP	Part ID	Light source	lm	kg
FLC240	139-1412 [HPF]	HIT-CE 150W G12	15000	13.4

Profile Projector for zoom spot

[BL] – GP	Part ID	Light source	lm	kg
FLC240	139-1414 [HPF]	HIT-CE 150W G12	15000	13.4

Profile Projector for projection of Gobos on to a surface, Gobo (D = 86 mm) steel or glass on request

[BL] – FP	Part ID	Light source	lm	kg
FLC240	139-1416 [HPF]	HIT-CE 150W G12	15000	13.4

Profile Projector for framing applications, polygon shape

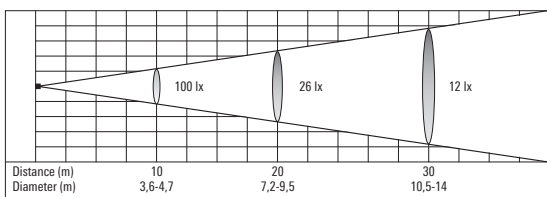
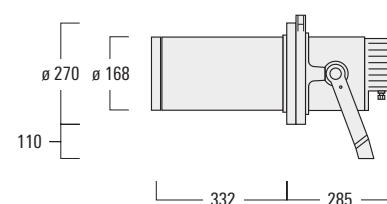
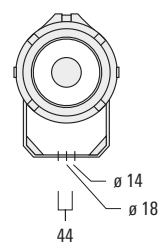

FLC200 COLOUR CHANGER + GOBO SERIES

CMY Colour Changer with Profile Projector.

IP66, Class I, IK09. Marine-grade die-cast aluminium alloy. 5CE superior corrosion protection including PCS hardware. Powdercoat finish in RAL 9004, RAL 9006, RAL 9007 or RAL 9016. Silicone rubber gasket. Safety glass lens, hinged. Anodised aluminium reflector. Integral ECG control gear.

- CMY dichroic colour filters for subtractive colour mixing
- Reset function and test program
- Storage of up to 99 scenes and 99 sequences, storage of up to 7 daily programs or 1 weekly program
- Stand alone function and master slave function
- 4 cross fading sequences
- Integrated calendar with timer function and integrated operation hour counter
- DMX in- and output and RJ45 interface
- WE-EF CONTROL® CMY-DMX PC based software supplied

Light source

HIT 150 W

Light distribution

[E]

Accessories

■ Mounting, page 322





[E] – ZP [E] – GP [E] – FP

[E] Narrow beam distribution, symmetric
Profile Projector for Zoom, Gobo or Framing applications

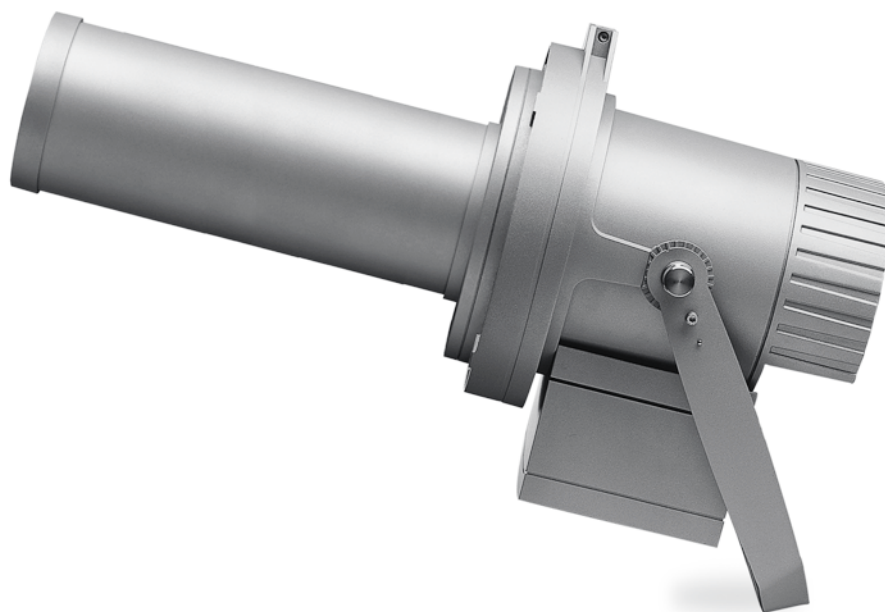

[E] – ZP	Part ID	Light source	lm	kg
FLC254-CC	139-1463 [ECG.DMX]	HIT-CE 150W G12	15000	24.9

Profile Projector for zoom spot

[E] – GP	Part ID	Light source	lm	kg
FLC254-CC [E]-GP	139-1464 [ECG.DMX]	HIT-CE 150W G12	15000	24.9

Profile Projector for projection of Gobos on to a surface, Gobo (D = 86 mm) steel or glass on request

[E] – FP	Part ID	Light source	lm	kg
FLC254-CC [E]-FP	139-1465 [ECG.DMX]	HIT-CE 150W G12	15000	24.9

Profile Projector for framing applications, polygon shape

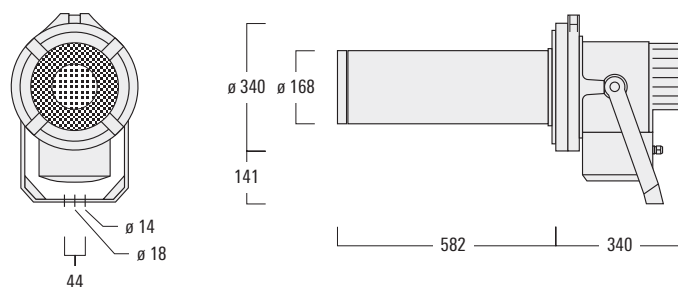

Individual programming via PC or the optional available WE-EF HH1 handheld programmer:

Part ID	
139-1218 [DMX]	HH1 handheld programmer including RS232 serial cable

- RS232 serial cable supplied with HH1 handheld
- Storage of up to 999 scenes and 999 sequences
- Storage of up to 99 daily, weekly, monthly or special day programs
- DMX interface

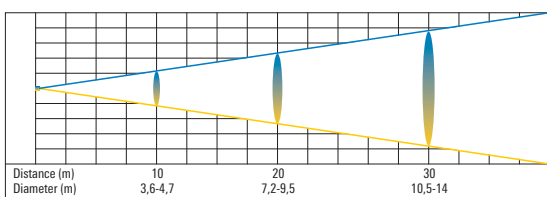

MOUNTING ACCESSORIES – FLC200 SERIES

Marine-grade aluminium construction. 5CE superior corrosion protection including PCS hardware. Powdercoat finish in RAL 9004, RAL 9006, RAL 9007 or RAL 9016.

Short post					kg
for FLC220 – FLC260	270-9038	EM1-M16	Short post		2.2
for FLC280	270-9039	EM1-M20	Short post		2.2

Matching planted root to be ordered separately:

Planted root for short post					kg
for FLC200 Series	300-0461	ESV4	Planted root		4.4

Galvanised steel

Ground spike					kg
for FLC210	139-1603	EF1	Ground spike		0.2

Stainless steel, including 5 m of flexible cable and plug

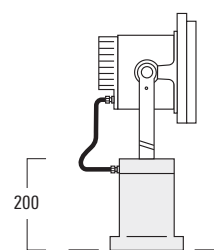

Short post EM1

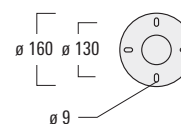

Planted root ESV4

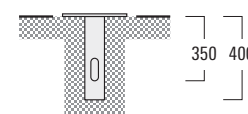

Ground spike EF1

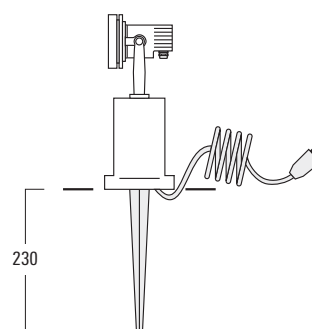

Pole clamps TS Series					D	kg
for FLC230	147-0371	TS1-2/M10	Pole clamp	ø 76-89	1.4	
	147-0372	TS1-2/M10	Pole clamp	ø 102-114	1.5	
	147-0373	TS2-2/M10	Pole clamp	ø 76-89	1.4	
	147-0374	TS2-2/M10	Pole clamp	ø 102-114	1.6	

for FLC220, FLC240–FLC260	147-0543	TS1-2/M12	Pole clamp	ø 76-89	1.4
	147-0526	TS1-2/M12	Pole clamp	ø 102-114	1.5
	147-0544	TS1-2/M12	Pole clamp	ø 114-133	1.7
	147-0545	TS2-2/M12	Pole clamp	ø 76-89	1.4
	147-0527	TS2-2/M12	Pole clamp	ø 102-114	1.5
	147-0546	TS2-2/M12	Pole clamp	ø 114-133	1.6

for FLC280	147-0547	TS1-2/M12	Pole clamp	ø 76-89	1.5
	147-0551	TS1-2/M12	Pole clamp	ø 102-114	1.6
	147-0548	TS1-2/M12	Pole clamp	ø 114-133	1.8
	147-0549	TS2-2/M12	Pole clamp	ø 76-89	1.5
	147-0552	TS2-2/M12	Pole clamp	ø 102-114	1.6
	147-0550	TS2-2/M12	Pole clamp	ø 114-133	1.7

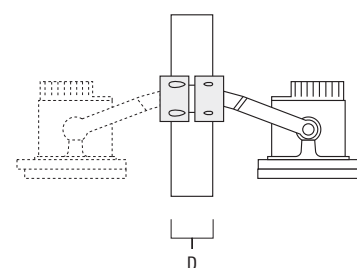

Pole clamps TS1/TS2

Hot dipped galvanised steel. Powdercoat finish in RAL 9004, RAL 9006, RAL 9007 or RAL 9016.

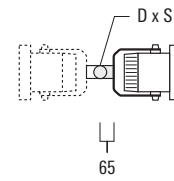

Mounting bracket TA1/TA2

Mounting brackets TA Series				D x S	kg
for FLC220 – 280	147-0023	TA1*	Mounting bracket	∅ 76 x 200	1.9
	147-0024	TA2*	Mounting bracket	∅ 76 x 200	1.9
	147-0105	TA2-L	Mounting bracket	∅ 76 x 200	16.1
	147-0025	TA3	Mounting bracket	∅ 89 x 200	20.8
	147-0099	TA4	Mounting bracket	∅ 89 x 200	20.8

*Mounting brackets TA1 und TA2 made from marine-grade aluminium.

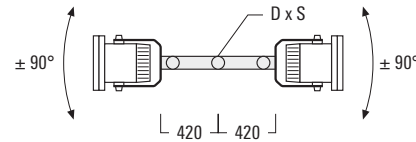

Mounting bracket TA2-L

for FLC220 – 280	147-0096	TA1	Mounting bracket	∅ 108 x 200	7.5
	147-0097	TA2	Mounting bracket	∅ 108 x 200	7.5
	147-0148	TA2-L	Mounting bracket	∅ 108 x 200	20.2
	147-0098	TA3	Mounting bracket	∅ 108 x 200	24.2
	147-0100	TA4	Mounting bracket	∅ 108 x 200	24.2

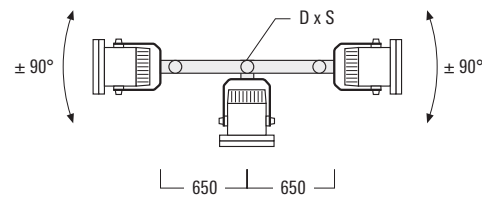

Mounting bracket TA3

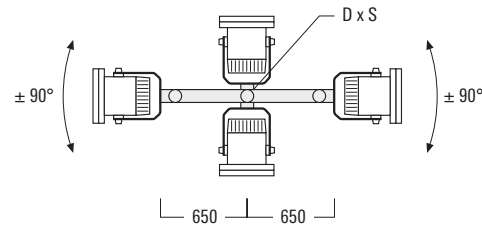

Mounting bracket TA4

ELECTRICAL ACCESSORIES – FLC200 SERIES

Gear boxes				kg
for HI 1000W	400-0121 [HPF]	DK5A	~ 230V / 9.30-9.60A	13.0
for HI 2000W	400-0271 [HPF]	DK6A	~ 400V / 9.60-11.30A	18.4

In pole gear trays				kg
for HI 1000W	400-0301 [HPF]	PT110 with 1 fuse E14	~ 230V / 9.30-9.60A	16.6
for HI 2000W	400-0180 [HPF]	PT110 with 2 fuses E14	~ 400V / 9.60-11.30A	16.6

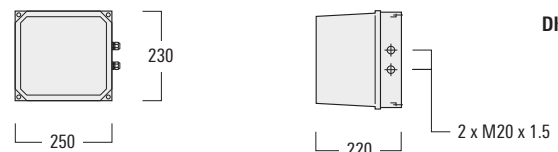

DK5A

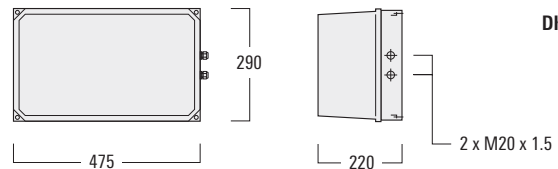

DK6A

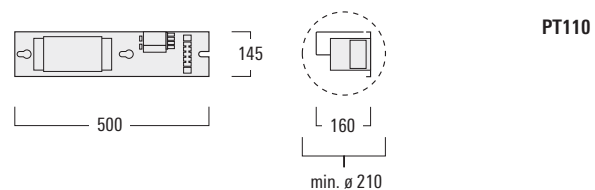

PT110

OPTICAL ACCESSORIES – FLC200 SERIES



Internal Accessories

A maximum of one internal optical accessory.

Flood lens IO-360

for FLC220	139-1850
for FLC240	139-1856
for FLC260	139-1862

Linear spread lens IO-180

for FLC220	139-1849
for FLC240	139-1855
for FLC260	139-1861

Wallwash lens IO-20*

for FLC220	139-1848
for FLC240	139-1854
for FLC260	139-1860

Honeycomb louvre IW

for FLC220	139-1851
for FLC240	139-1857
for FLC260	139-1863

* ideal for uniform wall washing applications

External Accessories

A maximum of one external optical accessory.

Glare shield ES

for FLC220	139-1852
for FLC240	139-1858
for FLC260	139-1864

Snoot ET

for FLC220	139-1853
for FLC240	139-1859
for FLC260	139-1865

OPTICAL ACCESSORIES – FLC200 SERIES

Internal Accessories

FLC210: A maximum of one internal optical accessory..

FLC230: A maximum of two internal optical accessories.

FLC240/250: A maximum of two internal optical accessories.

FLC280: A maximum of one internal optical accessory.

Flood lens IO-360

for FLC210	139-0837
for FLC230	139-1115
for FLC240	139-0861
for FLC250	139-0862

Linear spread lens IO-180

for FLC210	139-0836
for FLC230	139-1114
for FLC240	139-0863
for FLC250	139-0864

Colour filter IF	red	green	blue	yellow
for FLC210	139-0832	139-0833	139-0834	139-0835
for FLC230	139-1116	139-1117	139-1118	139-1119
for FLC240	139-0865	139-0866	139-0867	139-0868
for FLC250	139-0869	139-0870	139-0871	139-0872

Circular louvre IR

for FLC240	139-0726
for FLC250	139-0715
for FLC280	139-1228

Source shield IQ – only for versions with single-ended HID lamps

for FLC230 [EE]	139-1219
for FLC240 [EE]	139-0714
for FLC250 [EE]	139-1242

External Accessories

FLC210/230/240/250/254-CC: A maximum of one external optical accessory.

FLC280: A maximum of one optical accessory such as colour filter, flood or spread lens, wire guard, glare shield or snoot (combinations available on request).

Optical adaptor to be ordered separately.

Flood lens EO-360*

for FLC280	139-1227
------------	----------

Linear spread lens EO-180*

for FLC280	139-1226
------------	----------

Colour filter EF*	red	green	blue	yellow
for FLC280	139-1238	139-1239	139-1240	139-1241

External optical Adaptor EA

for FLC280	139-1233
------------	----------

Wire guard EG

for FLC230	139-1222
for FLC240	139-0707
for FLC250 / FLC254-CC	139-0708
for FLC280	139-1229

Glare shield ES

for FLC210	139-1008
for FLC230	139-1221
for FLC240	139-0709
for FLC250 / FLC254-CC	139-0710
for FLC280	139-1230

Snoot ET

for FLC230	139-1223
for FLC240	139-0711
for FLC250 / FLC254-CC	139-0712
for FLC280	139-1231

* external optical adaptor EA required, to be ordered separately

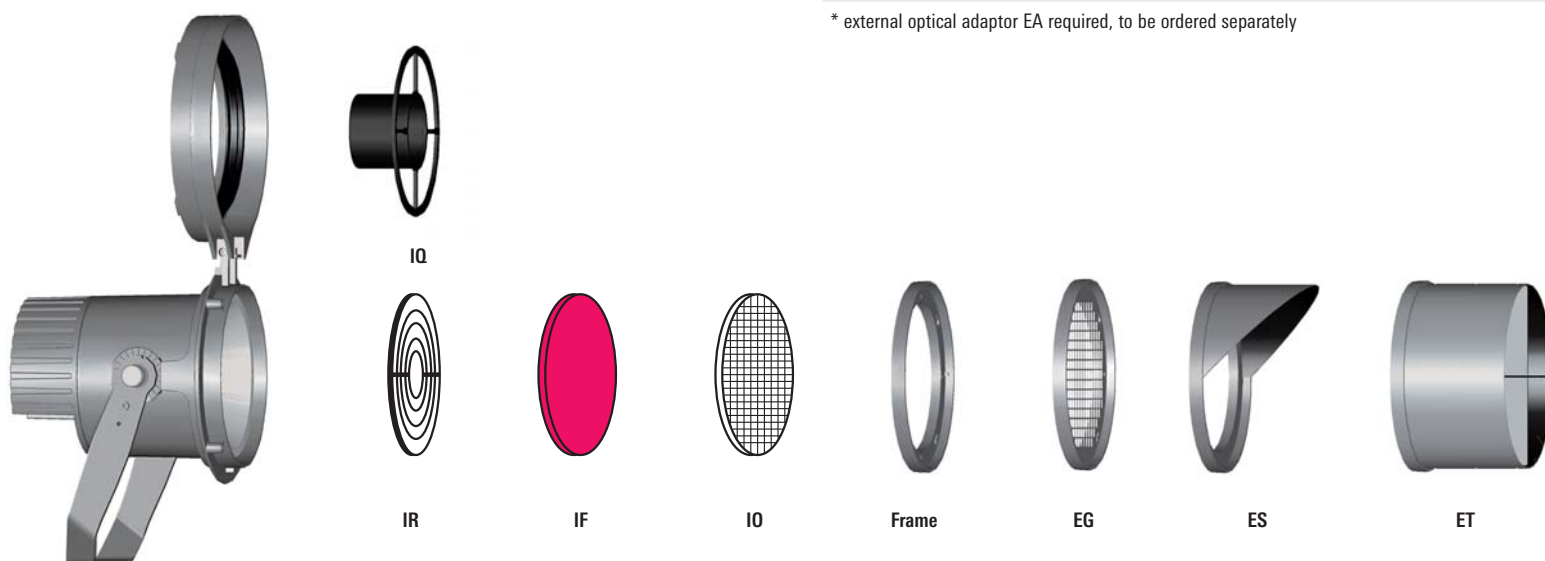

IOS® Beam distributions for floodlights

- [B] wide beam, bi-symmetric
- [M] medium beam, bi-symmetric
- [E] narrow beam, bi-symmetric
- [E10] narrow beam, 10° asymmetric
- [A45] wide beam, 45° asymmetric

Floodlights



FLB100

328



FLB400

330



ACCESSORIES

■ Mounting	336
■ Electrical	337
■ Optical	338

FLB100 SERIES

Bracket mounted floodlight, narrow or wide beam distribution, asymmetric.

IP55, Class I, IK08. Marine-grade die-cast aluminium alloy except outreach arm which is extruded. 5CE superior corrosion protection including PCS hardware. Powdercoat finish in RAL 9004, RAL 9006, RAL 9007 or RAL 9016. Silicone rubber gaskets. Safety glass lens, hinged. Anodised aluminium reflector. Two cable entries.

ECG control gear, thermally separated.

Knuckle permits 350° horizontal and 90° vertical aiming of optics.

Light source
HIT 70-150 W

Light distributions
[E10] [A45]

Accessories
■ Optical, page 338

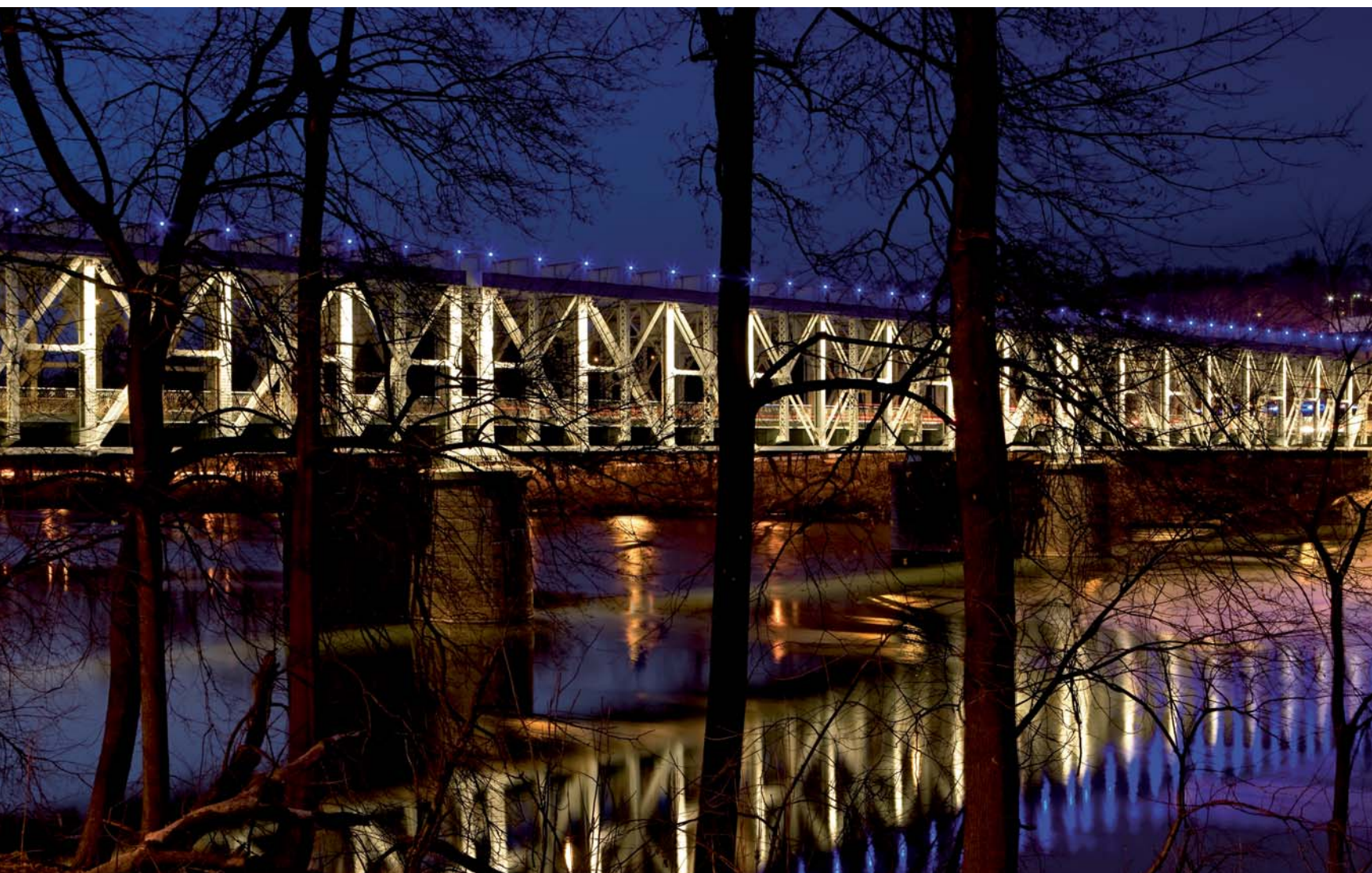

East Falls Bridge. Philadelphia, PA (USA). Lighting design: Grenald Waldraon Associates, Narberth, PA.

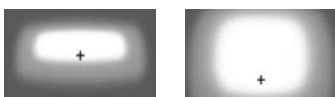

[E10]

[A45]

[E10] Narrow beam distribution, 10° asymmetric

[A45] Wide beam distribution, 45° asymmetric



[E10]	Part ID	Light source	lm	Factor*	kg
FLB141	161-9162 [ECG]	HIT-DE-CE 70W RX7s	6800	1.00	7.7
	161-9166 [ECG]	HIT-DE-CE 150W RX7s	14500	2.13	7.9

[A45]	Part ID	Light source	lm	Factor*	kg
FLB141	161-9284 [ECG]	HIT-DE-CE 70W RX7s	6800	1.00	7.7
	161-9288 [ECG]	HIT-DE-CE 150W RX7s	14500	2.13	7.9

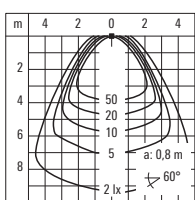
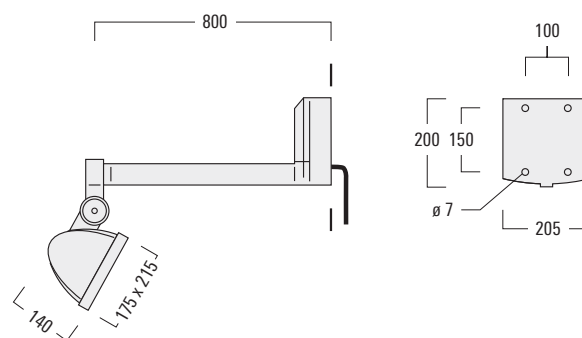

[E10]

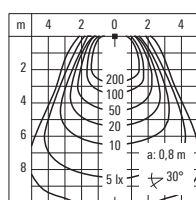

[A45]

* Multiplier for Isolux value

FLB400 SERIES

Floodlight, wide, medium, narrow beam distribution, bi-symmetric or narrow, wide beam distribution, asymmetric.

IP66, Class I. IK08. Marine-grade die-cast aluminium alloy. 5CE superior corrosion protection including PCS hardware. Powdercoat finish in RAL 9004, RAL 9006, RAL 9007 or RAL 9016. Silicone rubber gaskets. Safety glass lens, hinged. Anodised aluminium reflector.

HPF or ECG control gear (70-400 W), thermally separated up to 1000 W.

For 2000 W, remote HPF gear box made from marine-grade die-cast aluminium alloy or in pole HPF gear tray, to be ordered separately.

Light source
HIT 70-2000 W
HST 70-1000 W

Light distributions
[B] [M] [E] [E10] [A45]

Accessories

- Mounting, page 336
- Electrical, page 337
- Optical, page 338

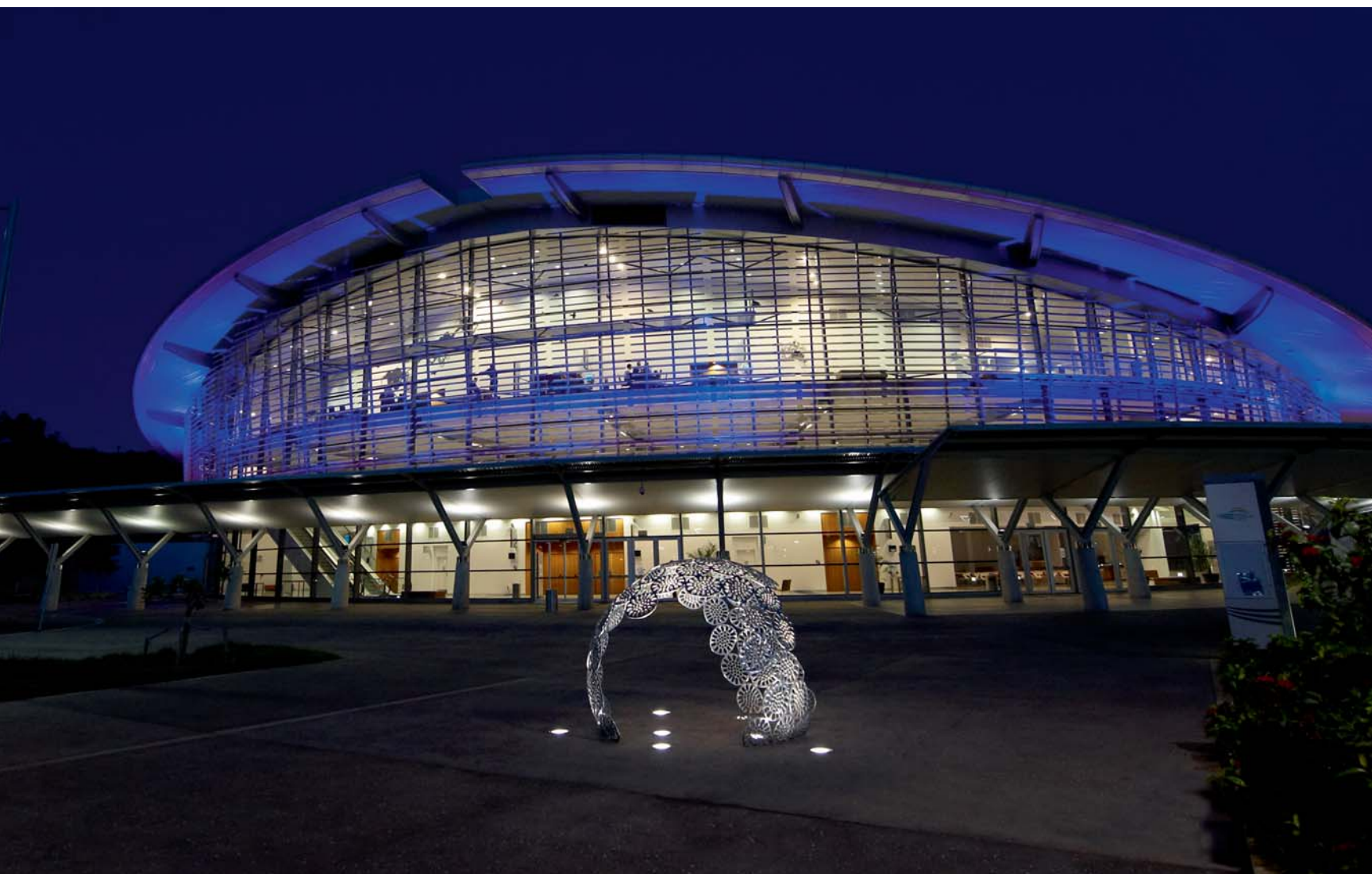

Darwin Convention Centre. Darwin (AUS)



[B] Wide beam distribution, bi-symmetric



[B]	Part ID	Light source	lm	cd/klm	C ₀ C ₁₈₀	C ₉₀ C ₂₇₀	kg
FLB440	161-9252 [HPF]	HIT-DE-CE 70W RX7s	6800	638	26°/26°	32°/32°	6.1
	161-9748 [ECG]	HIT-DE-CE 70W RX7s	6800	638	26°/26°	32°/32°	5.0
	161-9255 [HPF]	HIT-DE-CE 150W RX7s	14500	665	25°/25°	32°/32°	6.6
	161-9258 [HPF]	HST-DE-X4 70W RX7s	6800	675	26°/26°	31°/31°	6.2
	161-9261 [HPF]	HST-DE-X4 150W RX7s	15000	622	25°/25°	31°/31°	6.1
FLB460	161-9832 [HPF]	HIT-CE 250W E40	26000	642	22°/35°	37°/37°	14.1
	161-9835 [HPF]	HIT 400W E40	35000	566	24°/39°	36°/36°	16.3
	161-9861 [HPF]	HST-X4 250W E40	33200	533	29°/34°	39°/39°	14.1
	161-9864 [HPF]	HST-X4 400W E40	56500	562	28°/33°	36°/36°	16.3
FLB480	148-9018 [IGN]*	HIT-LA-DE 1000W K12s-36/Cable	100000	693	20°/18°	41°/41°	16.4
	148-9020 [IGN]*	HIT-LA-DE 2000W K12s-36/Cable	220000	628	23°/25°	42°/42°	16.4
	148-9022 [IGN]*	HST 1000W E40	130000	648	21°/19°	39°/39°	14.9

* Remote HPF gear box made from marine-grade die-cast aluminium alloy or in pole HPF gear tray, to be ordered separately.

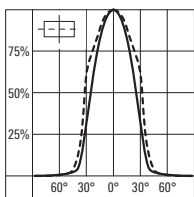

[B]

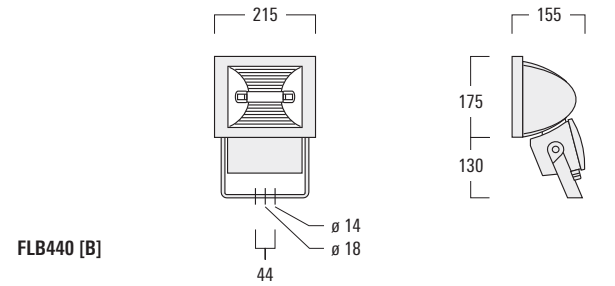

FLB440 [B]

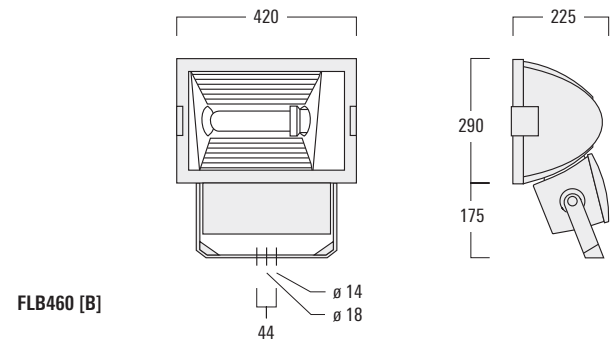

FLB460 [B]

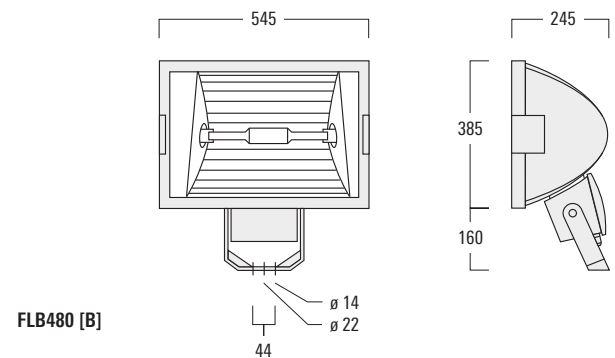

FLB480 [B]

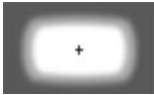

[M] Medium beam distribution, bi-symmetric

[M]	Part ID	Light source	lm	cd/klm	C ₀ C ₁₈₀	C ₉₀ C ₂₇₀	kg
FLB440	161-9183 [HPF]	HIT-DE-CE 70W RX7s	6800	1011	15°/15°	32°/32°	6.1
	161-9239 [ECG]	HIT-DE-CE 70W RX7s	6800	1011	15°/15°	32°/32°	5.0
	161-9186 [HPF]	HIT-DE-CE 150W RX7s	14500	926	16°/16°	32°/32°	6.6
	161-9192 [HPF]	HST-DE-X4 70W RX7s	6800	971	14°/14°	31°/31°	6.1
	161-9195 [HPF]	HST-DE-X4 150W RX7s	15000	897	15°/15°	31°/31°	6.6
FLB460	161-9323 [HPF]	HIT-CE 250W E40	26000	786	27°/10°	37°/37°	14.1
	161-9326 [HPF]	HIT 400W E40	35000	781	15°/23°	37°/37°	16.3
	161-9350 [HPF]	HST-X4 250W E40	33200	829	13°/21°	36°/36°	14.1
	161-9353 [HPF]	HST-X4 400W E40	56500	854	14°/18°	36°/36°	16.3
FLB480	148-9048 [IGN]*	HIT-LA-DE 1000W K12s-36/Cable	100000	842	16°/15°	40°/40°	16.4
	148-9050 [IGN]*	HIT-LA-DE 2000W K12s-36/Cable	220000	791	18°/15°	41°/41°	16.4
	148-9052 [IGN]*	HST 1000W E40	130000	828	15°/13°	38°/38°	16.4

* Remote HPF gear box made from marine-grade die-cast aluminium alloy or in pole HPF gear tray, to be ordered separately.

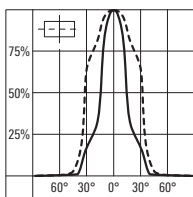

[M]

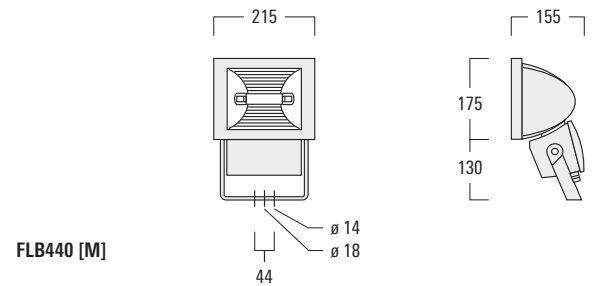

FLB440 [M]

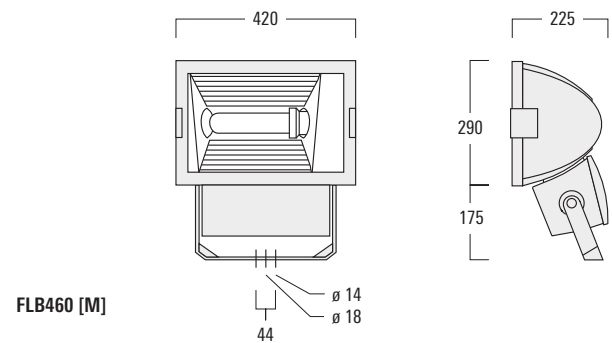

FLB460 [M]

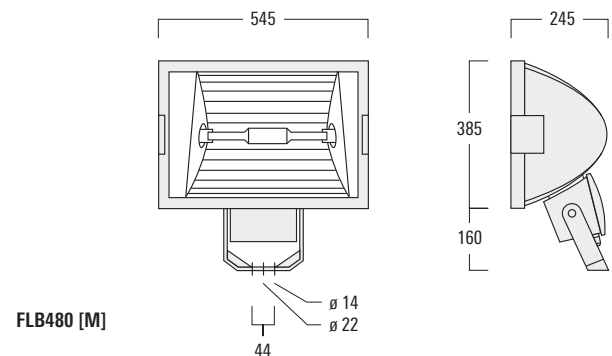

FLB480 [M]

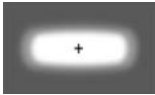

[E] Narrow beam distribution, bi-symmetric



[E]	Part ID	Light source	lm	cd/klm	C ₀ C ₁₈₀	C ₉₀ C ₂₇₀	kg
FLB440	161-9201 [HPF]	HIT-DE-CE 70W RX7s	6800	1716	7°/7°	33°/33°	6.1
	161-9243 [ECG]	HIT-DE-CE 70W RX7s	6800	1716	7°/7°	33°/33°	5.0
	161-9204 [HPF]	HIT-DE-CE 150W RX7s	14500	1426	9°/9°	33°/33°	6.6
	161-9210 [HPF]	HST-DE-X4 70W RX7s	6800	1770	6°/6°	32°/32°	6.1
	161-9213 [HPF]	HST-DE-X4 150W RX7s	15000	1564	7°/7°	32°/32°	6.6
FLB460	161-9392 [HPF]	HIT-CE 250W E40	26000	1168	7°/5°	38°/38°	14.1
	161-9395 [HPF]	HIT 400W E40	35000	1132	6°/7°	36°/36°	16.3
	161-9419 [HPF]	HST-X4 250W E40	33200	1272	6°/6°	40°/40°	14.1
	161-9422 [HPF]	HST-X4 400W E40	56500	1028	9°/6°	34°/34°	16.3
FLB480	148-9078 [IGN]*	HIT-LA-DE 1000W K12s-36/Cable	100000	1360	6°/6°	41°/41°	16.4
	148-9080 [IGN]*	HIT-LA-DE 2000W K12s-36/Cable	220000	1820	5°/4°	41°/41°	16.4
	148-9082 [IGN]*	HST 1000W E40	130000	1905	4°/4°	38°/38°	14.9

* Remote HPF gear box made from marine-grade die-cast aluminium alloy or in pole HPF gear tray, to be ordered separately.

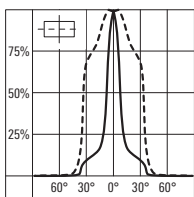

[E]

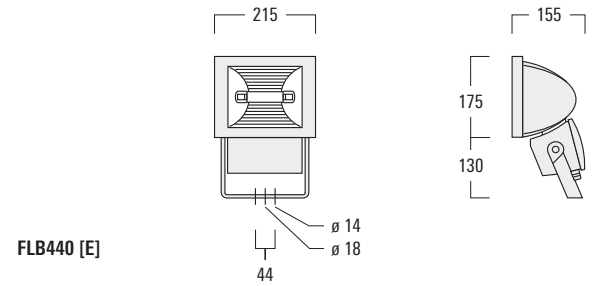

FLB440 [E]

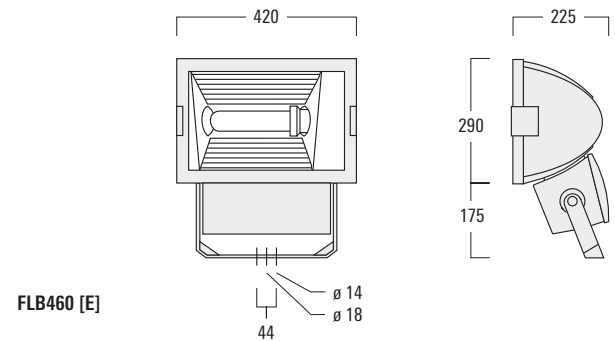

FLB460 [E]

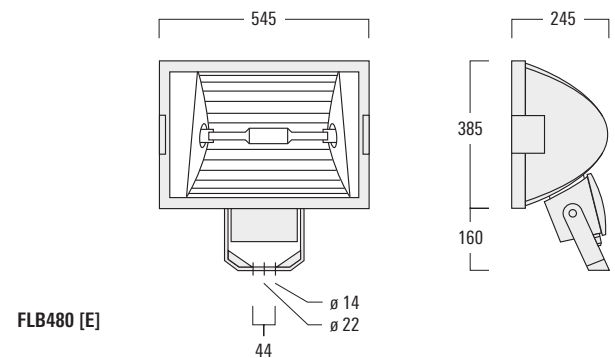

FLB480 [E]



[E10] Narrow beam distribution, 10° asymmetric

[E10]	Part ID	Light source	lm	cd/klm	C ₀ C ₁₈₀	C ₉₀ C ₂₇₀	kg
FLB440	161-9219 [HPF]	HIT-DE-CE 70W RX7s	6800	1645	5°/9°	34°/34°	6.1
	161-9726 [ECG]	HIT-DE-CE 70W RX7s	6800	1645	5°/9°	34°/34°	5.0
	161-9222 [HPF]	HIT-DE-CE 150W RX7s	14500	1128	8°/12°	34°/34°	6.6
	161-9228 [HPF]	HST-DE-X4 70W RX7s	6800	1492	4°/9°	32°/32°	6.1
	161-9231 [HPF]	HST-DE-X4 150W RX7s	15000	1392	6°/10°	33°/33°	6.6
FLB460	161-9440 [HPF]	HIT-DE 250W Fc2	20000	1801	7°/6°	44°/44°	14.1
	161-9443 [HPF]	HIT-DE 400W Fc2	36000	1591	7°/7°	44°/44°	16.3
	161-9452 [HPF]	HST-DE 250W Fc2	25500	1583	6°/6°	45°/45°	14.1
	161-9455 [HPF]	HST-DE 400W Fc2	48000	1683	6°/6°	45°/45°	16.3
FLB480	148-9096 [IGN]*	HIT-LA-DE 1000W K12s-36/Cable	100000	1801	7°/6°	44°/44°	16.4
	148-9098 [IGN]*	HIT-LA-DE 2000W K12s-36/Cable	220000	1591	7°/7°	44°/44°	16.4

* Remote HPF gear box made from marine-grade die-cast aluminium alloy or in pole HPF gear tray, to be ordered separately.

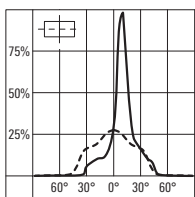

[E10]

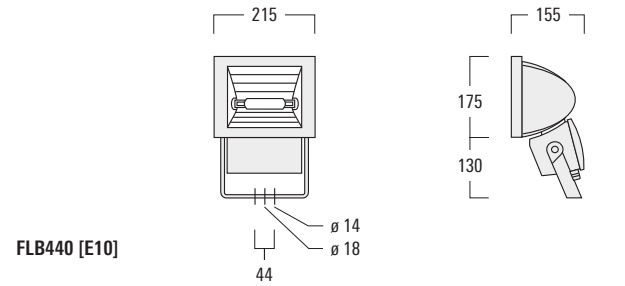

FLB440 [E10]

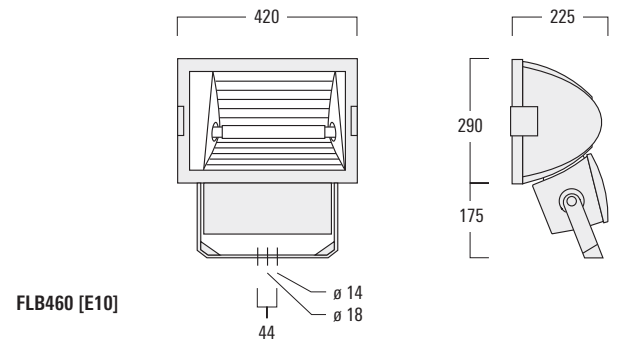

FLB460 [E10]

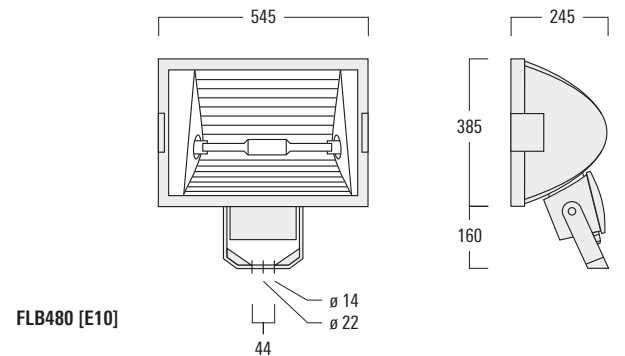

FLB480 [E10]

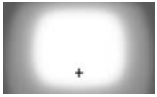

[A45] Wide beam distribution, 45° asymmetric



[A45]	Part ID	Light source	lm	cd/klm	C ₀ C ₁₈₀	C ₉₀ C ₂₇₀	kg
FLB440	161-9732 [HPF]	HIT-DE-CE 70W RX7s	6800	478	30°/22°	38°/38°	6.1
	161-9745 [ECG]	HIT-DE-CE 70W RX7s	6800	478	30°/22°	38°/38°	5.0
	161-9735 [HPF]	HIT-DE-CE 150W RX7s	14500	442	25°/26°	40°/40°	6.6
	161-9738 [HPF]	HST-DE-X4 70W RX7s	6800	518	27°/25°	40°/40°	6.1
	161-9741 [HPF]	HST-DE-X4 150W RX7s	15000	501	28°/22°	38°/38°	6.6
FLB460	161-9461 [HPF]	HIT-DE 250W Fc2	20000	381	37°/31°	53°/53°	14.1
	161-9464 [HPF]	HIT-DE 400W Fc2	36000	392	35°/33°	48°/48°	16.3
	161-9470 [HPF]	HST-DE 250W Fc2	25500	407	42°/27°	46°/46°	14.1
	161-9473 [HPF]	HST-DE 400W Fc2	48000	408	47°/22°	46°/46°	16.3
FLB480	148-9106 [IGN]*	HIT-LA-DE 1000W K12s-36/Cable	100000	381	27°/31°	53°/53°	16.4
	148-9108 [IGN]*	HIT-LA-DE 2000W K12s-36/Cable	220000	392	35°/33°	48°/48°	16.4

* Remote HPF gear box made from marine-grade die-cast aluminium alloy or in pole HPF gear tray, to be ordered separately.

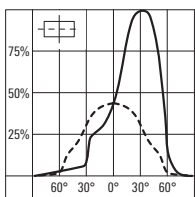

[A45]

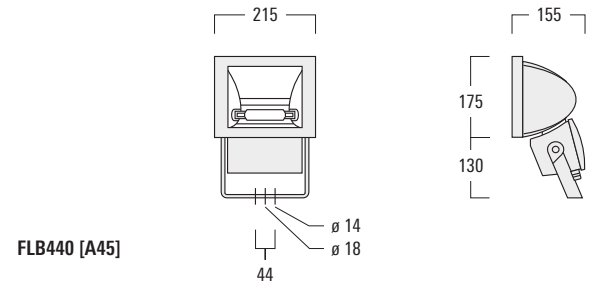

FLB440 [A45]

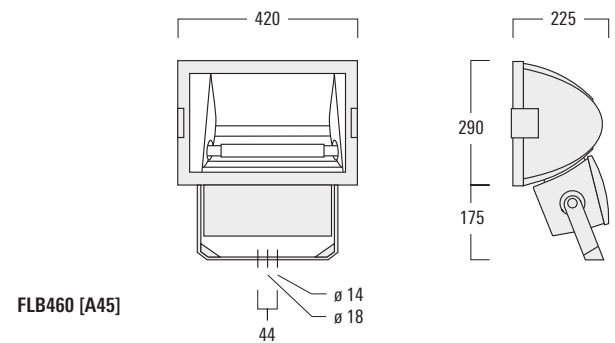

FLB460 [A45]

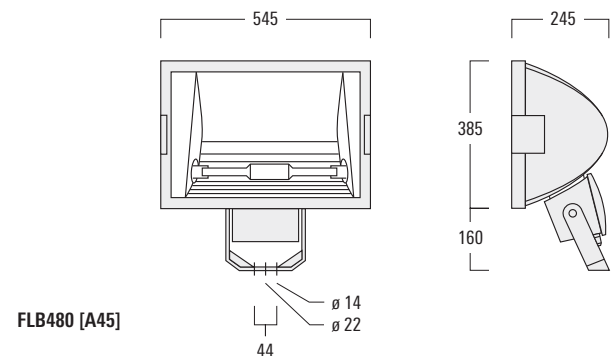

FLB480 [A45]

MOUNTING ACCESSORIES – FLB400 SERIES

Marine-grade aluminium construction. 5CE superior corrosion protection including PCS hardware. Powdercoat finish in RAL 9004, RAL 9006, RAL 9007 or RAL 9016.

Short post					kg
for FLB440 / 460	270-9038	EM1-M16	Short post		2.0
for FLB480	270-9039	EM1-M20	Short post		2.0

Matching planted root to be ordered separately:

Planted root for short post					kg
for FLB400 Series	300-0461	ESV4	Planted root		4.4

Galvanised steel

Pole clamps					D	kg
for FLB440 / 460	147-0543	TS1-2/M12	Pole clamp	76-89	1.4	
	147-0526	TS1-2/M12	Pole clamp	102-114	1.5	
	147-0544	TS1-2/M12	Pole clamp	114-133	1.7	
	147-0545	TS2-2/M12	Pole clamp	76-89	1.4	
	147-0527	TS2-2/M1	Pole clamp	102-114	1.5	
for FLB480	147-0546	TS2-2/M12	Pole clamp	114-133	1.6	
	147-0547	TS1-2/M12	Pole clamp	76-89	1.5	
	147-0551	TS1-2/M12	Pole clamp	102-114	1.6	
	147-0548	TS1-2/M12	Pole clamp	114-133	1.8	
	147-0549	TS2-2/M12	Pole clamp	76-89	1.5	
147-0552	TS2-2/M12	Pole clamp	102-114	1.6		
147-0550	TS2-2/M12	Pole clamp	114-133	1.7		

Spigot caps					D	kg
for FLB440 / 460	300-0198	KF1-M16	Spigot cap	60	0.5	
	300-0201	KF1-M16	Spigot cap	76	0.5	
	300-0203	KF1-M16	Spigot cap	89	0.5	
	300-0207	KF1-M16	Spigot cap	108	0.5	

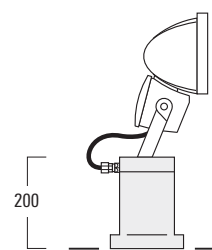

Short post EM1

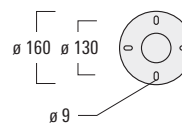

Planted root ESV4

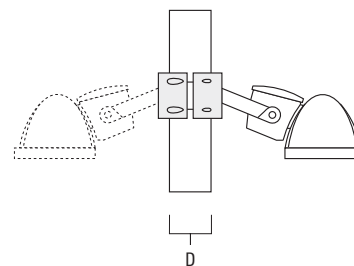
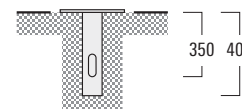

Pole clamp TS1/TS2

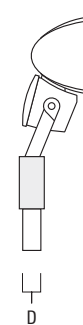

Spigot cap KF1

ELECTRICAL ACCESSORIES – FLB400 SERIES

Gear boxes				kg
for HI 1000W	400-0121 [HPF]	DK5A	~ 230V / 9.30-9.60A	13.0
for HS 1000W	400-0126 [HPF]	DK5A	~ 230V / 10.30A	13.0
for HI 2000W	400-0271 [HPF]	DK6A	~ 400V / 9.60-11.30A	18.4

In pole gear trays				kg
for HI 1000W	400-0301 [HPF]	PT110 with 1 fuse D01	~ 230V / 9.30-9.60A	16.6
for HS 1000W	400-0173 [HPF]	PT110 with 1 fuse D01	~ 230V / 10.30A	16.6
for HI 2000W	400-0180 [HPF]	PT110 with 2 fuses D01	~ 400V / 9.60-11.30A	16.6

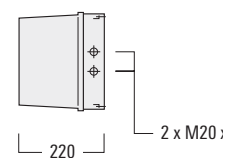
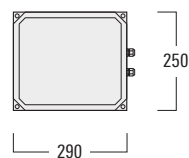

DK5A

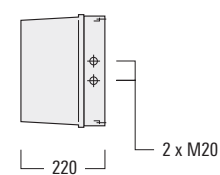
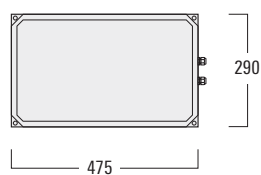

DK6A

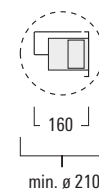
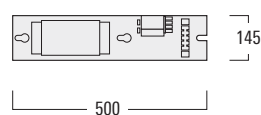

PT110

OPTICAL ACCESSORIES

Internal

FLB141 / FLB440 / FLB460: A maximum of two internal optical accessories.

The optical adaptor IA has to be ordered separately. Refer to accessories as marked* to determine need for optical adaptor.

FLB480: A maximum of one internal optical accessory.

Flood lens IO-360*

for FLB141 [E10]	161-9127
for FLB440 [M] [E] [E10]	161-9127
for FLB460 [M] [E] [E10]	161-9548

Wallwash lens IO*

for FLB141 [E10]	161-9126
for FLB440 [M] [E] [E10]	161-9126
for FLB460 [M] [E] [E10]	161-9547

Colour filter IF**/**	red	green	blue	yellow
for FLB141	161-9131	161-9129	161-9128	161-9130
for FLB440	161-9131	161-9129	161-9128	161-9130
for FLB460	161-9552	161-9550	161-9549	161-9551

Horizontal louvre IL

for FLB440 [B] [M]	161-9116*
for FLB460 [B] [M]	161-9563
for FLB480 [B] [M]	148-9230

for FLB440 [E]	161-9113*
for FLB460 [E]	161-9544
for FLB480 [E]	148-9231

Linear source shield IQ

for FLB440 [E]	161-9117*
for FLB460 [E]	161-9555
for FLB480 [E]	148-9226

Internal optical adaptor IA

for FLB141	161-9115
for FLB440	161-9115
for FLB460	161-9546

External

FLB141 / FLB440 / FLB460: A maximum of one external optical accessory.

FLB480: A maximum of three external accessories.

Flood lens EO-360

for FLB480 [M] [E] [E10]	148-9237
--------------------------	----------

Wallwash lens EO

for FLB480 [M] [E] [E10]	148-9236
--------------------------	----------

Colour filter EF**	red	green	blue	yellow
for FLB480	148-9240	148-9241	148-9242	148-9243

Wire guard EG

for FLB141	161-9118
for FLB440	161-9118
for FLB460	161-9556
for FLB480	148-9260

Glare shield ES

for FLB141	161-9121
for FLB440 [B] [M] [E]	161-9121
for FLB460 [B] [M] [E]	161-9558
for FLB480 [B] [M] [E]	148-9262

Barn doors ED

for FLB141	161-9119
for FLB440	161-9119
for FLB460	161-9557
for FLB480	148-9266

* Requires optical adaptor IA which has to be ordered separately.

** Dichroic colour filters, in combination with bi-symmetric or asymmetric reflectors, exhibit a pronounced 'rainbow effect'.

If this is not suitable, contact your local WE-EF representative for optional absorption colour filters.

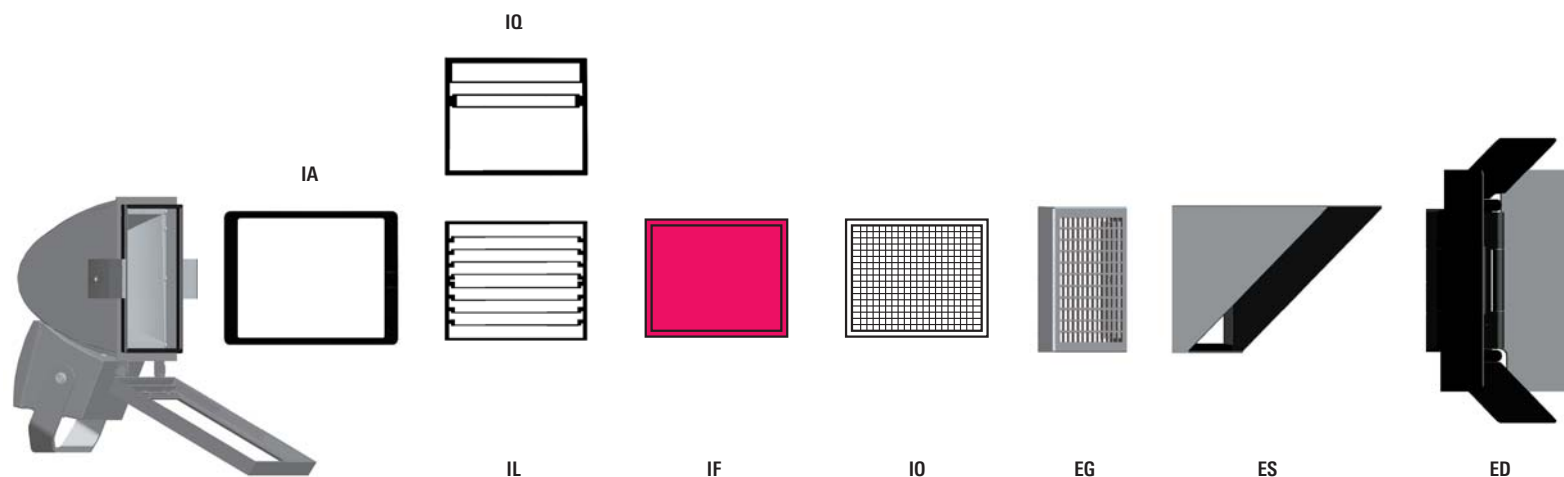



Darwin Convention Centre. Darwin (AUS)

IOS® Beam distributions for area floodlights

[S60] streetlighting

[S65] streetlighting

[A60] forward throw, asymmetric

[R65] rectangular forward throw

Area floodlights



FLA700 LED 342



FLA700 344



ACCESSORIES FLA700

- Mounting 352
- Electrical 352
- Optical 356



FLA400 LED 358

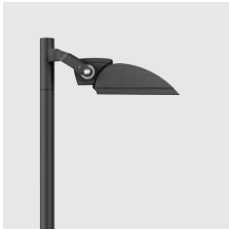

FLA400 360



ACCESSORIES FLA400

- Mounting 364
- Optical 368

FLA700 SERIES

Floodlight, side or forward throw distribution, asymmetric.

IP66, Class I. IK08. Marine-grade die-cast aluminium alloy. 5CE superior corrosion protection including PCS hardware. Powdercoat finish in RAL 9004, RAL 9006, RAL 9007 or RAL 9016. Silicone rubber gaskets. Safety glass lens, hinged.

Protractor scale for accurate aiming from 0° to 15° above horizontal.

Integral EC electronic converter.

Factory installed LED circuit board. LED boards can be easily removed for upgrading. PMMA OLC® LED lenses for superior illumination and glare control.

Recommended mounting height 2.5-12.0 m, depending on lamp type selected.

Light source

LED 24-72 W, 4000 K,
for 3000 K refer to www.we-ef.com

Light distributions

[S65] [A60] [R65]

Accessories

■ Mounting, page 352



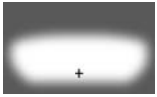

[S65] Streetlighting distribution



[S65]	Part ID	Light source	K	lm*	Factor**	kg
FLA730	147-0686	12 LED 24W / 700 mA	4000	2951	1.00	7.4
	147-0716	18 LED 36W / 700 mA	4000	4427	1.50	7.4
	147-0704	12 LED 36W / 1050mA	4000	5400	1.83	7.4
	147-0692	18 LED 54W / 1050 mA	4000	8100	2.75	7.4
FLA740	147-0710	18 LED 36W / 700 mA	4000	4427	1.50	9.6
	147-0722	24 LED 48W / 700 mA	4000	5903	2.00	9.6
	147-0698	18 LED 54W / 1050 mA	4000	8100	2.75	9.6
	147-0680	24 LED 72W / 1050 mA	4000	10800	3.66	9.6

FLA730

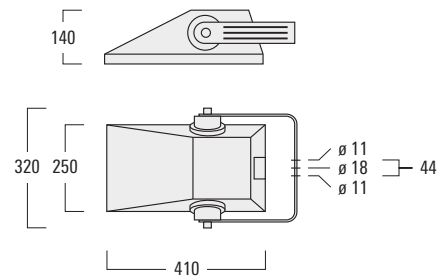

FLA740

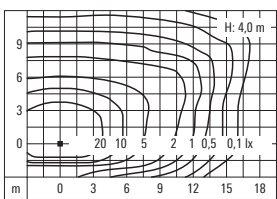
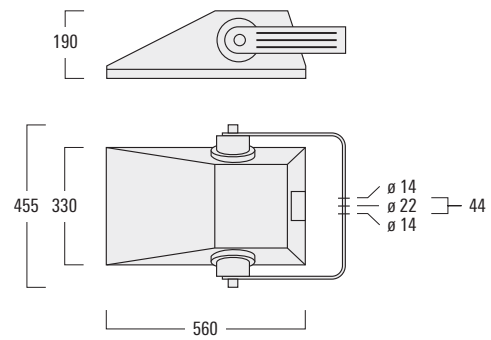

[S65]

* Nominal lumen output based on LED manufacturers data at 85°C T_J. For rated lumens at 25°C T_q and latest data refer to www.we-ef.com.
 ** Multiplier for Isolux value

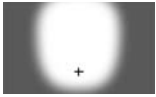

[A60] Forward throw distribution, asymmetric

[A60]	Part ID	Light source	K	lm*	Factor**	kg
FLA730	147-0690	12 LED 24W / 700 mA	4000	2951	1.00	7.4
	147-0720	18 LED 36W / 700 mA	4000	4427	1.50	7.4
	147-0708	12 LED 36W / 1050mA	4000	5400	1.83	7.4
FLA740	147-0696	18 LED 54W / 1050 mA	4000	8100	2.75	7.4
	147-0714	18 LED 36W / 700 mA	4000	4427	1.50	9.6
	147-0726	24 LED 48W / 700 mA	4000	5903	2.00	9.6
	147-0702	18 LED 54W / 1050 mA	4000	8100	2.75	9.6
	147-0684	24 LED 72W / 1050 mA	4000	10800	3.66	9.6



FLA730

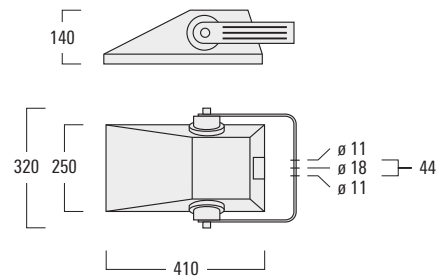

FLA740

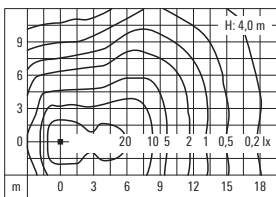
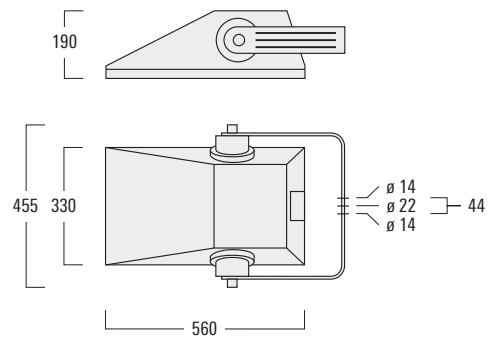

[A60]

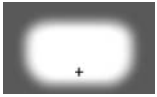

[R65] Rectangular forward throw distribution



[R65]	Part ID	Light source	K	lm*	Factor**	kg
FLA730	147-0688	12 LED 24W / 700 mA	4000	2951	1.00	7.4
	147-0718	18 LED 36W / 700 mA	4000	4427	1.50	7.4
	147-0706	12 LED 36W / 1050mA	4000	5400	1.83	7.4
	147-0694	18 LED 54W / 1050 mA	4000	8100	2.75	7.4
FLA740	147-0712	18 LED 36W / 700 mA	4000	4427	1.50	9.6
	147-0724	24 LED 48W / 700 mA	4000	5903	2.00	9.6
	147-0700	18 LED 54W / 1050 mA	4000	8100	2.75	9.6
	147-0682	24 LED 72W / 1050 mA	4000	10800	3.66	9.6

FLA730

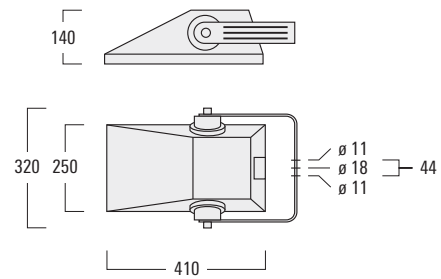

FLA740

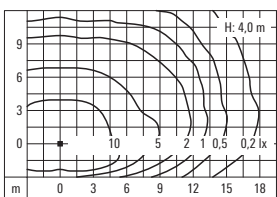
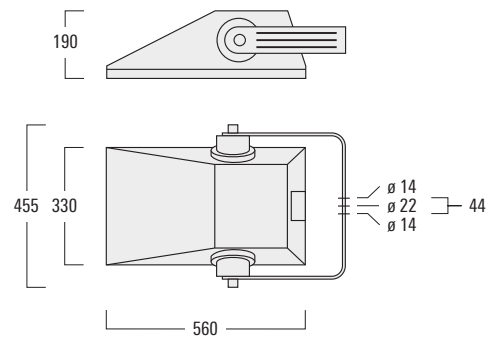

[R65]

* Nominal lumen output based on LED manufacturers data at 85°C T_J. For rated lumens at 25°C T_q and latest data refer to www.we-ef.com.

** Multiplier for Isolux value

FLA700 SERIES

Floodlight, side or forward throw distribution, asymmetric.

IP66, Class I, IK08. Marine-grade die-cast aluminium alloy. 5CE superior corrosion protection including PCS hardware. Powdercoat finish in RAL 9004, RAL 9006, RAL 9007 or RAL 9016. Silicone rubber gaskets. Safety glass lens, hinged. Anodised aluminium reflector.

Protractor scale for accurate aiming from 0° to 15° above horizontal.

Integral HPF or ECG control gear on hinged and 'no tool' removable gear tray.

Recommended mounting height 2.5-12.0 m, depending on lamp type selected.

Light source

TC 32-57 W

HIT 45-400 W

HST 70-400 W

Light distribution

[S60] [A60]

Accessories

■ Mounting, page 352

■ Electrical, page 352

■ Optical, page 356

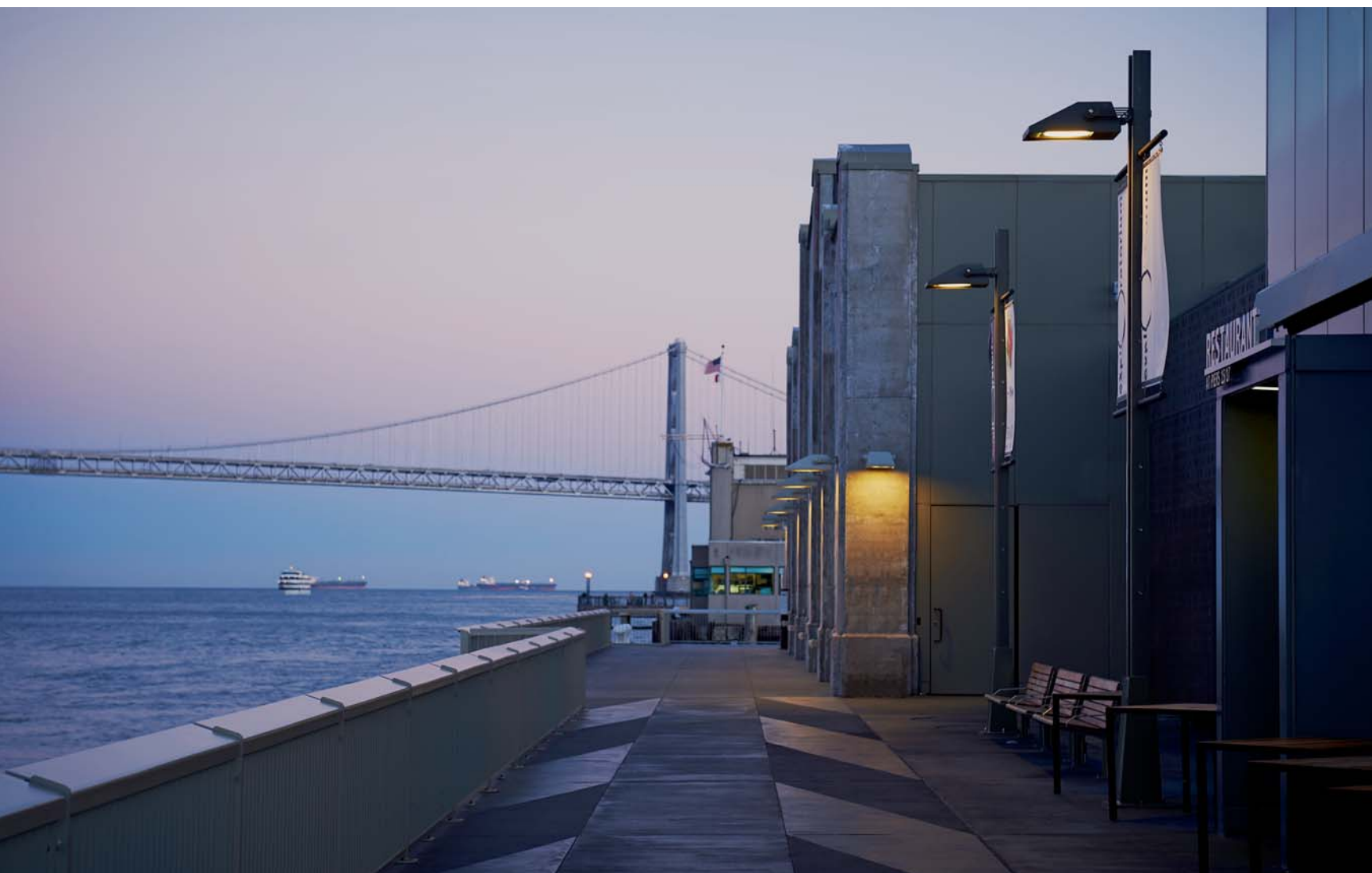

Exploratorium. San Francisco, California (USA). Architect: EHDD. Lighting design: David Nelsen & Associates.

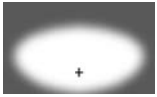

[S60]

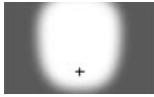

[A60]

[S60] Side throw distribution, asymmetric

[A60] Forward throw distribution, asymmetric



[S60]	Part ID	Light source	lm	Factor*	kg
FLA730	147-0334 [ECG]	TC-TELI 32W GX24q-3	2400	0.56	7.4
	147-0504 [ECG]	HIT-CE 20W G12	1650	0.38	7.4
	147-0335 [ECG]	HIT-CE 35W G12	3600	0.84	7.4
	147-0336 [ECG]	HIT-CE 70W G12	7300	1.70	7.4

[A60]	Part ID	Light source	lm	Factor*	kg
FLA730	147-0337 [ECG]	TC-TELI 32W GX24q-3	2400	0.56	7.4
	147-0510 [ECG]	HIT-CE 20W G12	1650	0.38	7.4
	147-0338 [ECG]	HIT-CE 35W G12	3600	0.84	7.4
	147-0339 [ECG]	HIT-CE 70W G12	7300	1.70	7.4

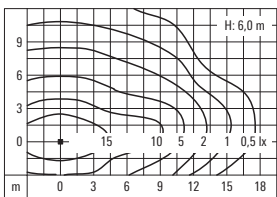
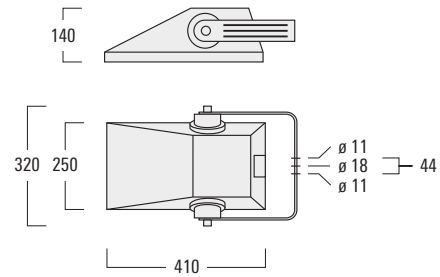

[S60]

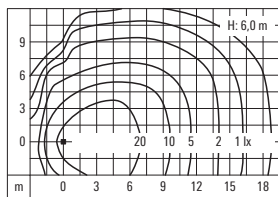

[A60]

* Multiplier for Isolux value

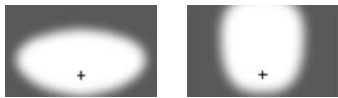

[S60]

[A60]

[S60] Side throw distribution, asymmetric

[A60] Forward throw distribution, asymmetric



[S60]	Part ID	Light source	lm	Factor*	kg
FLA740	147-0268 [ECG]	TC-TELI 42W GX24q-4	3200	0.46	9.1
	147-0228 [ECG]	TC-TELI 57W GX24q-5	4300	0.61	9.1
	147-0481 [ECG]	HIT-COS 90W PGZ12	10450	1.49	9.6
	147-0511 [ECG]	HIT-COS 140W PGZ12	16500	2.36	9.6
	147-0187 [HPF]	HIT-CE 70W E27	7000	1.00	14.7
	147-0229 [ECG]	HIT-CE 70W E27	7000	1.00	13.6
	147-0164 [HPF]	HIT-CE 150W E40	14500	2.07	15.2
	147-0347 [ECG]	HIT-CE 150W E40	14500	2.07	14.1
	147-0231 [HPF]	HST-X4 70W E27	6600	0.94	14.7
	147-0376 [ECG]	HST-X4 70W E27	6600	0.94	13.6
	147-0233 [HPF]	HST-X4 100W E40	10700	1.53	15.1
	147-0507 [ECG]	HST-X4 100W E40	10700	1.53	14.0
	147-0177 [HPF]	HST-X4 150W E40	17500	2.50	15.2
	147-0508 [ECG]	HST-X4 150W E40	17500	2.50	14.1

[A60]	Part ID	Light source	lm	Factor*	kg
FLA740	147-0485 [ECG]	HIT-COS 90W PGZ12	10450	1.49	9.6
	147-0513 [ECG]	HIT-COS 140W PGZ12	16500	2.36	9.6
	147-0001 [HPF]	HIT-CE 70W E27	7000	1.00	14.7
	147-0183 [ECG]	HIT-CE 70W E27	7000	1.00	13.6
	147-0002 [HPF]	HIT-CE 150W E40	14500	2.07	15.2
	147-0352 [ECG]	HIT-CE 150W E40	14500	2.07	14.1
	147-0176 [HPF]	HST-X4 70W E27	6600	0.94	14.7
	147-0346 [ECG]	HST-X4 70W E27	6600	0.94	13.6
	147-0004 [HPF]	HST-X4 100W E40	10700	1.53	15.1
	147-0516 [ECG]	HST-X4 100W E40	10700	1.53	14.0
	147-0005 [HPF]	HST-X4 150W E40	17500	2.50	15.2
	147-0517 [ECG]	HST-X4 150W E40	17500	2.50	14.1

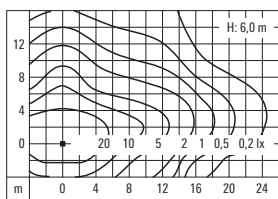
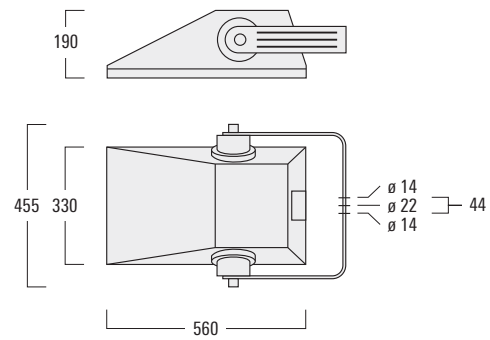

[S60]

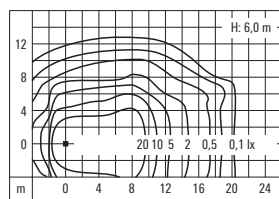

[A60]

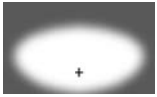

[S60]

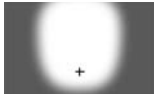

[A60]

[S60] Side throw distribution, asymmetric

[A60] Forward throw distribution, asymmetric



[S60]	Part ID	Light source	lm	Factor*	kg
FLA760	147-0483 [ECG]	HIT-COS 140W PGZ12	16500	0.64	17.7
	147-0173 [HPF]	HIT-CE 250W E40	26000	1.00	20.4
	147-0235 [HPF]	HIT 400W E40	35000	1.35	22.6
	147-0224 [HPF]	HST-X4 250W E40	33200	1.28	20.4
	147-0240 [HPF]	HST-X4 400W E40	56500	2.17	22.6

[A60]	Part ID	Light source	lm	Factor*	kg
FLA760	147-0487 [ECG]	HIT-COS 140W PGZ12	16500	0.64	17.7
	147-0011 [HPF]	HIT-CE 250W E40	26000	1.00	20.4
	147-0013 [HPF]	HIT 400W E40	35000	1.35	22.6
	147-0019 [HPF]	HST-X4 250W E40	33200	1.28	20.4
	147-0022 [HPF]	HST-X4 400W E40	56500	2.17	22.6

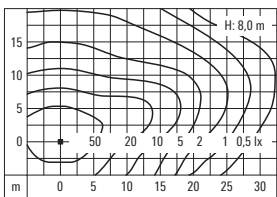
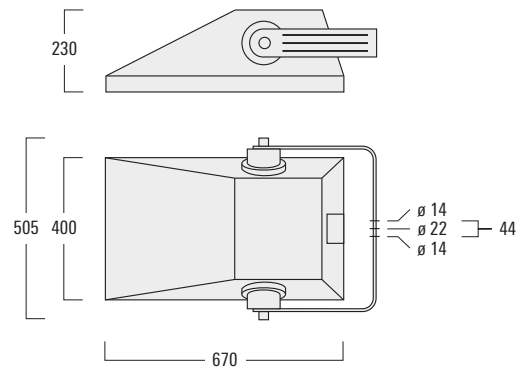

[S60]

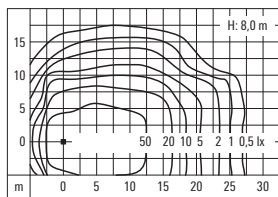

[A60]

* Multiplier for Isolux value

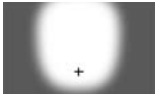

[A60] Forward throw distribution, asymmetric



[A60]	Part ID	Light source	lm	Factor*	kg
FLA780	147-0489 [IGN]	2 x HIT 400W E40	2 x 35000	1.00	34.0
	147-0490 [IGN]	2 x HST-X4 400W E40	2 x 56500	1.61	34.0
	147-0365 [HPF]	HST-X4 600W E40	90000	1.28	40.0
	147-0367 [HPF]	HST 1000W E40	130000	1.86	43.0
	147-0360 [HPF]	HIT-LA-DE 1000W Cable	100000	1.43	43.0

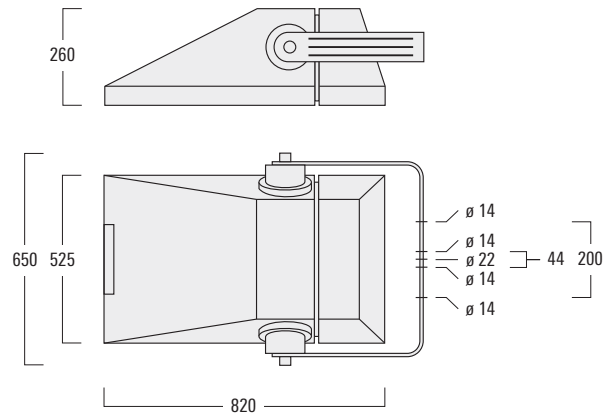

1 lamp

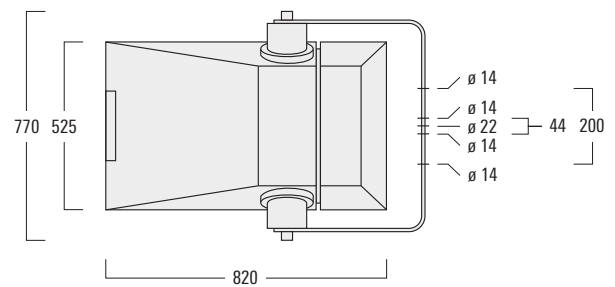

2 lamps

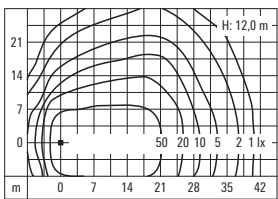

[A60]

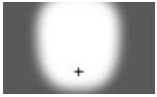

[A60] Forward throw distribution, asymmetric



[A60]	Part ID	Light source	lm	Factor*	kg
FLA780	147-0361 [IGN]**	HIT-LA-DE 2000W Cable	220000	1.00	27.0

** Remote HPF gear box made from marine-grade die-cast aluminium alloy or in pole HPF gear tray, to be ordered separately.

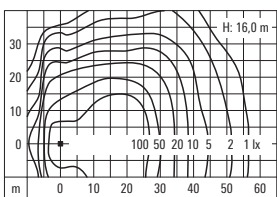
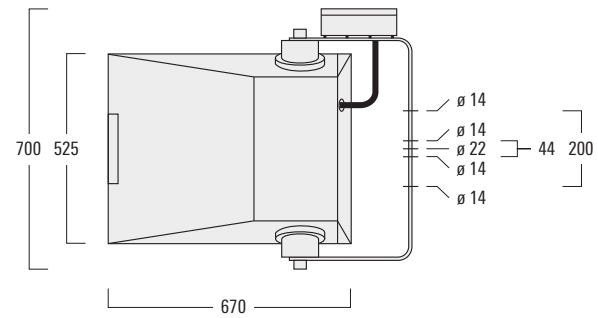
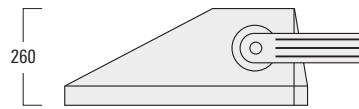

[A60]

* Multiplier for Isolux value

MOUNTING ACCESSORIES – FLA700 SERIES

Marine-grade aluminium construction. 5CE superior corrosion protection including PCS hardware. Powdercoat finish in RAL 9004, RAL 9006, RAL 9007 or RAL 9016.

Short post				kg
for FLA730	270-9038	EM1-M16	Short post	2.0

Matching planted root to be ordered separately:

Planted root for short post				kg
for FLA730	300-0461	ESV4	Planted root	4.4

Galvanised steel

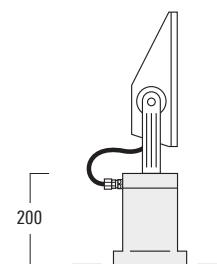

Short post EM1

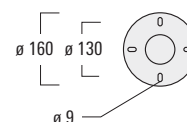

Planted root ESV4

Pole clamps TS Series				D	kg
for FLA730	147-0371	TS1-2/M10	Pole clamp	ø 76-89	1.3
	147-0372	TS1-2/M10	Pole clamp	ø 102-114	1.4
	147-0373	TS2-2/M10	Pole clamp	ø 76-89	1.3
	147-0374	TS2-2/M10	Pole clamp	ø 102-114	1.4

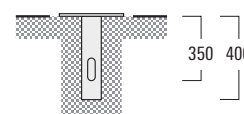

for FLA740	147-0543	TS1-2/M12	Pole clamp	ø 76-89	1.4
	147-0526	TS1-2/M12	Pole clamp	ø 102-114	1.5
	147-0544	TS1-2/M12	Pole clamp	ø 114-133	1.7
	147-0545	TS2-2/M12	Pole clamp	ø 76-89	1.4
	147-0527	TS2-2/M12	Pole clamp	ø 102-114	1.5
	147-0546	TS2-2/M12	Pole clamp	ø 114-133	1.7

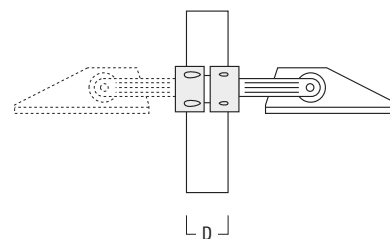

Pole clamp TS1/TS2

for FLA760	147-0547	TS1-2/M12	Pole clamp	ø 76-89	1.7
	147-0551	TS1-2/M12	Pole clamp	ø 102-114	1.8
	147-0548	TS1-2/M12	Pole clamp	ø 114-133	1.9
	147-0549	TS2-2/M12	Pole clamp	ø 76-89	1.7
	147-0552	TS2-2/M12	Pole clamp	ø 102-114	1.8
	147-0550	TS2-2/M12	Pole clamp	ø 114-133	1.9

ELECTRICAL ACCESSORIES – FLA700 SERIES

				kg
for HI 2000W	400-0271 [HPF]	DK6A	~ 400V / 9.60-11.30A	17.5
for HI 2000W	400-0180 [HPF]	PT110 with 2 fuses E14	~ 400V / 9.60-11.30A	16.6

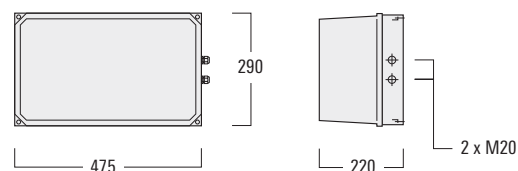

DK6A

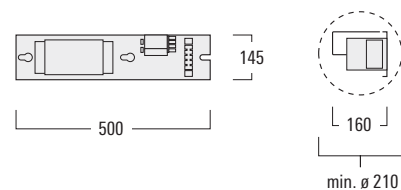

PT110



Airport Carpark. Melbourne (AUS)

MOUNTING ACCESSORIES – FLA700 SERIES

Hot dipped galvanised steel. Powdercoat finish in RAL 9004, RAL 9006, RAL 9007 or RAL 9016.

Floodlight mounting brackets TA Series				D x S	kg
for FLA730	147-0397	TA1	Mounting bracket	∅ 76 x 200	1.7
	147-0398	TA2	Mounting bracket	∅ 76 x 200	1.8
	147-0404	TA3	Mounting bracket	∅ 76 x 200	17.9

for FLA740 / 760	147-0023	TA1*	Mounting bracket	∅ 76 x 200	1.9
	147-0024	TA2*	Mounting bracket	∅ 76 x 200	2.0
	147-0105	TA2-L	Mounting bracket	∅ 76 x 200	16.1
	147-0557	TA3-L	Mounting bracket	∅ 89 x 200	20.8
	147-0465	TA4-L	Mounting bracket	∅ 89 x 200	22.6

*Mounting brackets TA1 and TA2 made from marine-grade aluminium.

for FLA760 / 780	147-0096	TA1	Mounting bracket	∅ 108 x 200	7.5
	147-0097	TA2	Mounting bracket	∅ 108 x 200	7.6
	147-0148	TA2-L	Mounting bracket	∅ 108 x 200	20.2
	147-0556	TA3-L	Mounting bracket	∅ 108 x 200	24.2
	147-0213	TA4-L	Mounting bracket	∅ 108 x 200	26.0

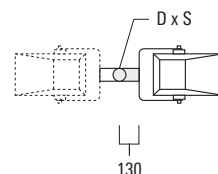

Mounting bracket TA1/TA2

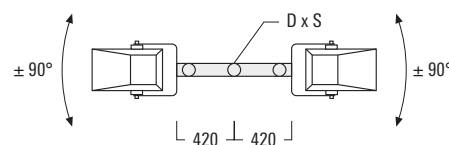

Mounting bracket TA2-L

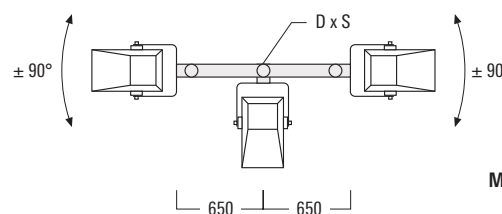

Mounting bracket TA3

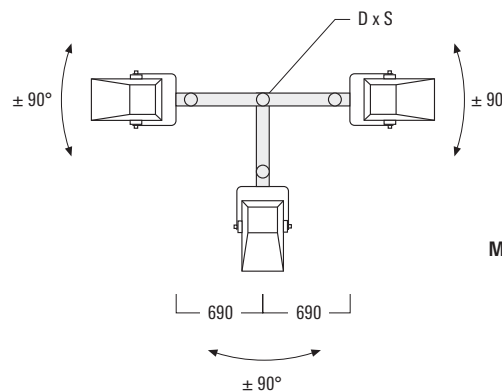

Mounting bracket TA3-L

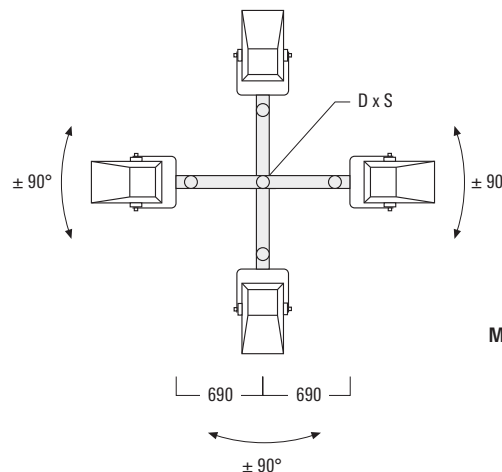

Mounting bracket TA4-L



OPTICAL ACCESSORIES – FLA700 SERIES

A maximum of one internal optical accessory.



Rearward cut-off shield

for [S] version, with side throw distribution.

for FLA730	108-0427
for FLA740	108-0469
for FLA760	108-0040



Rearward cut-off shield

for [A] version, with forward throw distribution.

for FLA730	147-0655
for FLA740	147-0656
for FLA760	147-0410
for FLA780	147-0657



Sideways cut-off shield

for [A] version, with forward throw distribution.

for FLA730	108-0428
for FLA740	108-0470
for FLA760	108-0041

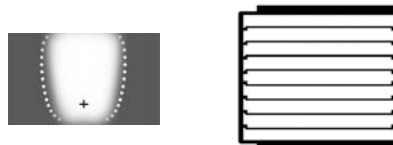

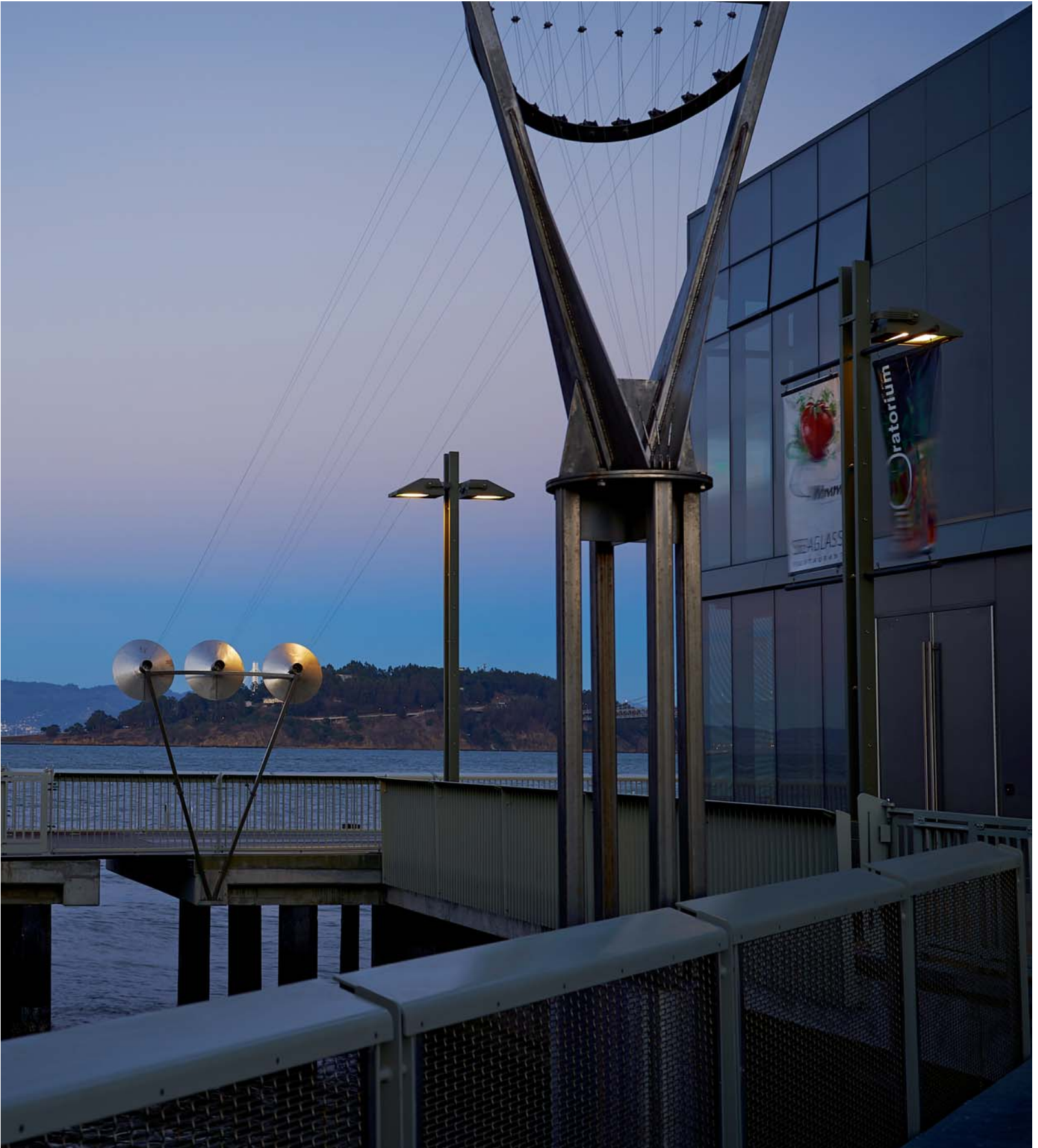

Exploratorium. San Francisco, California (USA). Architect: EHDD. Lighting design: David Nelsen & Associates.

FLA400 SERIES

Floodlight, side or forward throw distribution, asymmetric.

IP66, Class I. IK08. Marine-grade die-cast aluminium alloy. 5CE superior corrosion protection including PCS hardware. Powdercoat finish in RAL 9004, RAL 9006, RAL 9007 or RAL 9016. Silicone rubber gaskets. Safety glass lens, hinged.

Protractor scale incorporating locking pin for accurate and permanent aiming.

Integral EC electronic converter on hinged and 'no tool' removable gear tray.

Factory installed LED circuit board. LED boards can be easily removed for upgrading. PMMA OLC® LED lenses for superior illumination and glare control.

Recommended mounting height 6.0-12.0 m, depending on lamp type selected.

Light source

LED 36-108 W, 4000 K,
for 3000 K refer to www.we-ef.com

Light distributions

[S65] [A60] [R65]

Accessories

■ Mounting, page 364



Hossegor (F). Lighting design: Sydec 40.



[S65]

[A60]

[R65]

[S65] Streetlighting distribution

[A60] Forward throw distribution, asymmetric

[R65] Rectangular forward throw distribution



[S65]	Part ID	Light source	K	lm*	Factor**	kg
FLA440	108-7702	18 LED 36W / 700 mA	4000	4427	0.55	9.7
	108-7712	18 LED 54W / 1050 mA	4000	8100	1.00	9.7
FLA460	108-7723	36 LED 72W / 700 mA	4000	8854	1.09	28.3
	108-7333	36 LED 108W / 1050 mA	4000	16200	2.00	28.3

[A60]	Part ID	Light source	K	lm*	Factor**	kg
FLA440	108-7708	18 LED 36W / 700 mA	4000	4427	0.55	9.7
	108-7718	18 LED 54W / 1050 mA	4000	8100	1.00	9.7
FLA460	108-7729	36 LED 72W / 700 mA	4000	8854	1.09	28.3
	108-7339	36 LED 108W / 1050 mA	4000	16200	2.00	28.3

[R65]	Part ID	Light source	K	lm*	Factor**	kg
FLA440	108-7706	18 LED 36W / 700 mA	4000	4427	0.55	9.7
	108-7716	18 LED 54W / 1050 mA	4000	8100	1.00	9.7
FLA460	108-7727	36 LED 72W / 700 mA	4000	8854	1.09	28.3
	108-7337	36 LED 108W / 1050 mA	4000	16200	2.00	28.3

FLA440

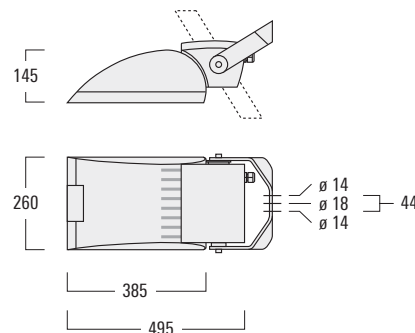

FLA460

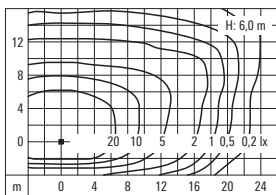
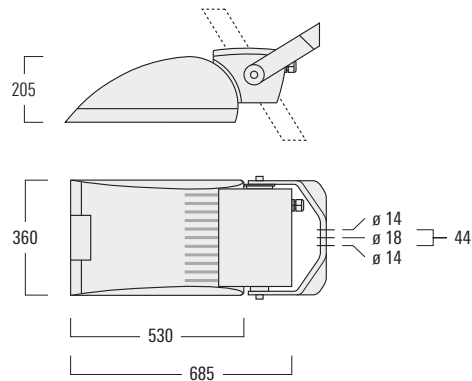

[S65]

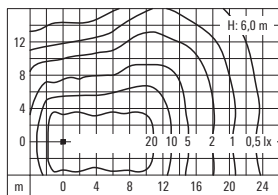

[A60]

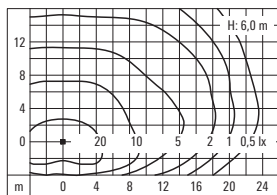

[R65]

* Nominal lumen output based on LED manufacturers data at 85°C T_J. For rated lumens at 25°C T_q and latest data refer to www.we-ef.com.

** Multiplier for Isolux value

FLA400 SERIES

Floodlight, side throw distribution, asymmetric.

IP66, Class I. IK08. Marine-grade die-cast aluminium alloy. 5CE superior corrosion protection including PCS hardware. Powdercoat finish in RAL 9004, RAL 9006, RAL 9007 or RAL 9016. Silicone rubber gaskets. Safety glass lens, hinged.

Integral HPF or ECG control gear, thermally separated. Anodised aluminium reflector.

'No tool' lamp replacement.

Recommended mounting height 6.0-12.0 m, depending on lamp type selected.

Light source

HIT 90-400 W

HST 250-400 W

Light distribution

[S60]

Accessories

■ Mounting, page 364

■ Optical, page 368



Goodwill Bridge. Brisbane (AUS). Architect: Cox Rayner Architects. Lighting design: Webbs Australia.

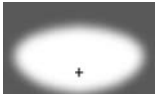

[S60] Side throw distribution, asymmetric



[S60]	Part ID	Light source	lm	Factor*	kg
FLA440	108-9164 [ECG]	HIT-COS 90W PGZ12	10450	0.70	9.7
	108-9168 [ECG]	HIT-COS 140W PGZ12	16500	1.10	9.7
	108-7019 [HPF]	HIT-CE 150W G12	15000	1.00	10.6
	108-7021 [ECG]	HIT-CE 150W G12	15000	1.00	9.5
	108-7024 [HPF]	HIT-CE 250W G12	23000	1.53	11.3
FLA460	108-7107 [HPF]	HIT-CE 250W E40	26000	1.00	28.3
	108-7157 [HPF]	HIT 400W E40	35000	1.35	30.5
	108-7110 [HPF]	HST-X4 250W E40	33200	2.21	28.3
	108-7160 [HPF]	HST-X4 400W E40	56500	3.77	30.5

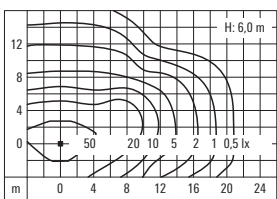
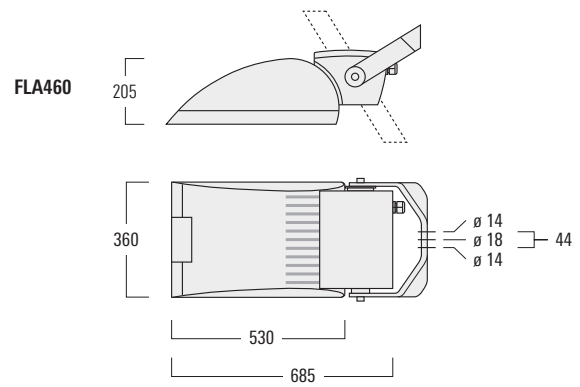
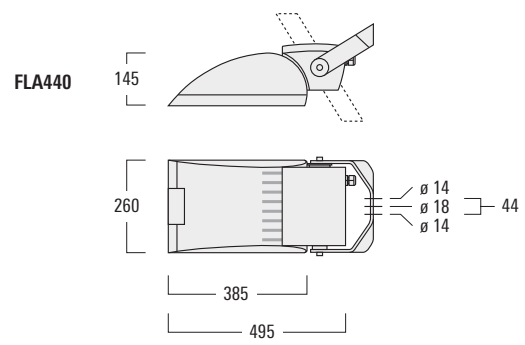

[S60]

* Multiplier for Isolux value

FLA400 SERIES

Floodlight, forward throw distribution, asymmetric.

IP66, Class I. IK08. Marine-grade die-cast aluminium alloy. 5CE superior corrosion protection including PCS hardware. Powdercoat finish in RAL 9004, RAL 9006, RAL 9007 or RAL 9016. Silicone rubber gaskets. Safety glass lens, hinged.

Integral HPF or ECG control gear, thermally separated. Anodised aluminium reflector.

'No tool' lamp replacement.

Recommended mounting height 6.0-12.0 m, depending on lamp type selected.

Light source

HIT 90-400 W

HST 250-400 W

Light distribution

[A60]

Accessories

■ Mounting, page 364

■ Optical, page 368



Goodwill Bridge. Brisbane (AUS). Architect: Cox Rayner Architects. Lighting design: Webbs Australia.



[A60] Forward throw distribution, asymmetric



[A60]	Part ID	Light source	lm	Factor*	kg
FLA440	108-7688 [ECG]	HIT-COS 90W PGZ12	10450	0.70	9.2
	108-7690 [ECG]	HIT-COS 140W PGZ12	16500	1.10	9.2
	108-7048 [HPF]	HIT-DE-CE 150W RX7s	14500	1.00	10.6
	108-7050 [ECG]	HIT-DE-CE 150W RX7s	14500	1.00	9.5
FLA460	108-7088 [HPF]	HIT-DE 250W Fc2	20000	1.53	11.3
	108-7118 [HPF]	HIT-DE 250W Fc2	20000	1.00	28.3
	108-7168 [HPF]	HIT-DE 400W Fc2	36000	1.35	30.5
	108-7121 [HPF]	HST-DE 250W Fc2	25500	2.21	28.3
	108-7171 [HPF]	HST-DE 400W Fc2	48000	3.77	30.5

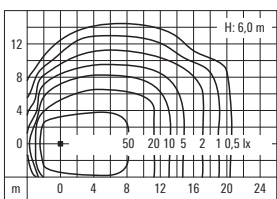
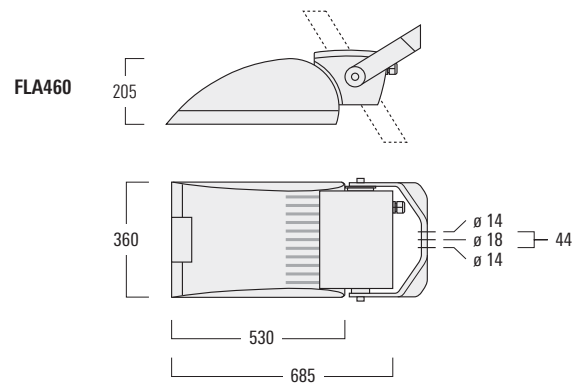
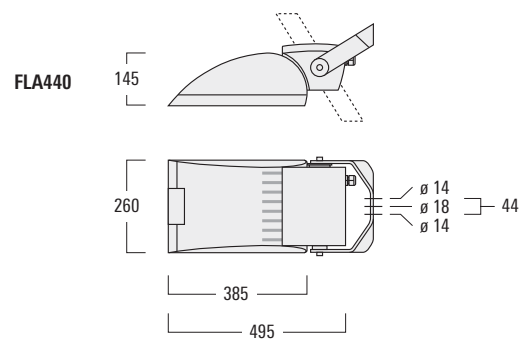

[A60]

* Multiplier for Isolux value

MOUNTING ACCESSORIES – FLA400 SERIES

Marine-grade aluminium construction. 5CE superior corrosion protection including PCS hardware. Powdercoat finish in RAL 9004, RAL 9006, RAL 9007 or RAL 9016.

Short post					kg
for FLA440 / 460	270-9038	EM1-M16	Short post		2.0

Matching planted root to be ordered separately:

Planted root for short post					kg
for FLA440 / 460	300-0461	ESV4	Planted root		4.4

Galvanised steel

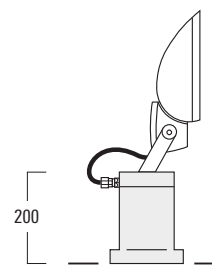

Short post EM1

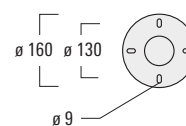

Planted root ESV4

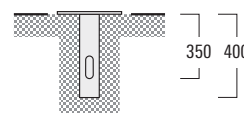

Pipe clamps SP Series				D	kg
for FLA440 / 460	146-0241	SP1-M16	Pipe clamp	∅ 38-60	1.3
	146-0242	SP1-M16	Pipe clamp	∅ 76-89	1.3
	146-0243	SP2-M16	Pipe clamp	∅ 38-60	1.6
	146-0244	SP2-M16	Pipe clamp	∅ 76-89	1.6

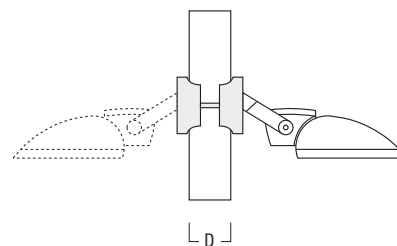

Pipe clamp SP1/SP2

Pole clamps TS Series				D	kg
for FLA440	147-0543	TS1-2/M12	Pole clamp	∅ 76-89	1.4
	147-0526	TS1-2/M12	Pole clamp	∅ 102-114	1.5
	147-0544	TS1-2/M12	Pole clamp	∅ 114-133	1.7
	147-0545	TS2-2/M12	Pole clamp	∅ 76-89	1.4
	147-0527	TS2-2/M12	Pole clamp	∅ 102-114	1.5
	147-0546	TS2-2/M12	Pole clamp	∅ 114-133	1.7

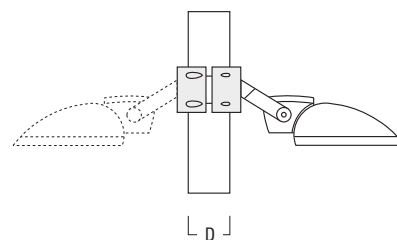

Pole clamp TS1/TS2

for FLA460	147-0547	TS1-2/M12	Pole clamp	∅ 76-89	1.7
	147-0551	TS1-2/M12	Pole clamp	∅ 102-114	1.8
	147-0548	TS1-2/M12	Pole clamp	∅ 114-133	1.9
	147-0549	TS2-2/M12	Pole clamp	∅ 76-89	1.7
	147-0552	TS2-2/M12	Pole clamp	∅ 102-114	1.8
	147-0550	TS2-2/M12	Pole clamp	∅ 114-133	1.9



Hossegor (F). Lighting design: Sydec 40.

MOUNTING ACCESSORIES – FLA400 SERIES

Hot dipped galvanised steel. Powdercoat finish in RAL 9004, RAL 9006, RAL 9007 or RAL 9016.

Floodlight mounting brackets TA Series				D x S	kg
for FLA440 / 460	147-0023	TA1*	Mounting bracket	∅ 76 x 200	1.9
	147-0024	TA2*	Mounting bracket	∅ 76 x 200	2.0
	147-0105	TA2-L	Mounting bracket	∅ 76 x 200	16.1
	147-0025	TA3	Mounting bracket	∅ 89 x 200	17.9
	147-0557	TA3-L	Mounting bracket	∅ 89 x 200	20.8
	147-0465	TA4-L	Mounting bracket	∅ 89 x 200	22.6

*Mounting brackets TA1 and TA2 made from marine-grade aluminium.

for FLA460	147-0096	TA1	Mounting bracket	∅ 108 x 200	7.5
	147-0097	TA2	Mounting bracket	∅ 108 x 200	7.6
	147-0148	TA2-L	Mounting bracket	∅ 108 x 200	20.2
	147-0556	TA3-L	Mounting bracket	∅ 108 x 200	24.2
	147-0213	TA4-L	Mounting bracket	∅ 108 x 200	26.0

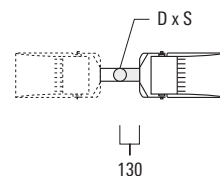

Mounting bracket TA1/TA2

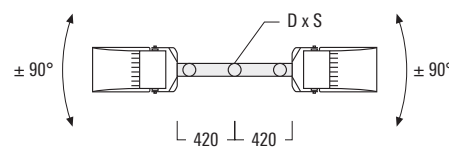

Mounting bracket TA2-L

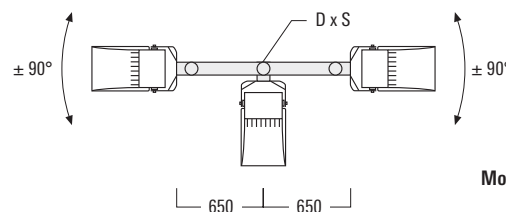

Mounting bracket TA3

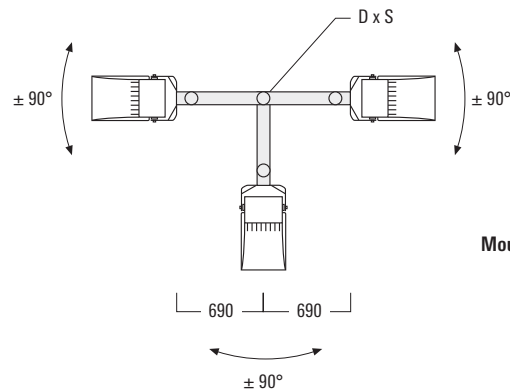

Mounting bracket TA3-L

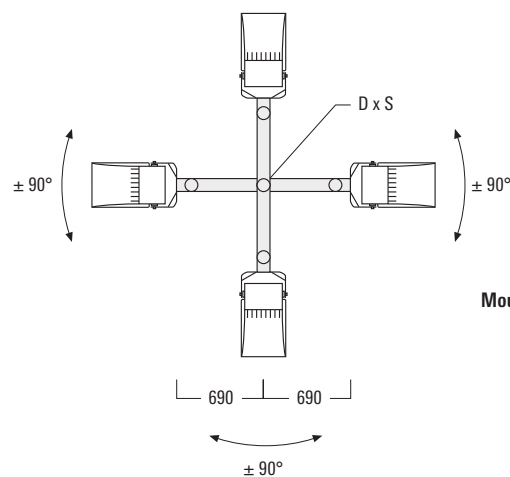

Mounting bracket TA4-L

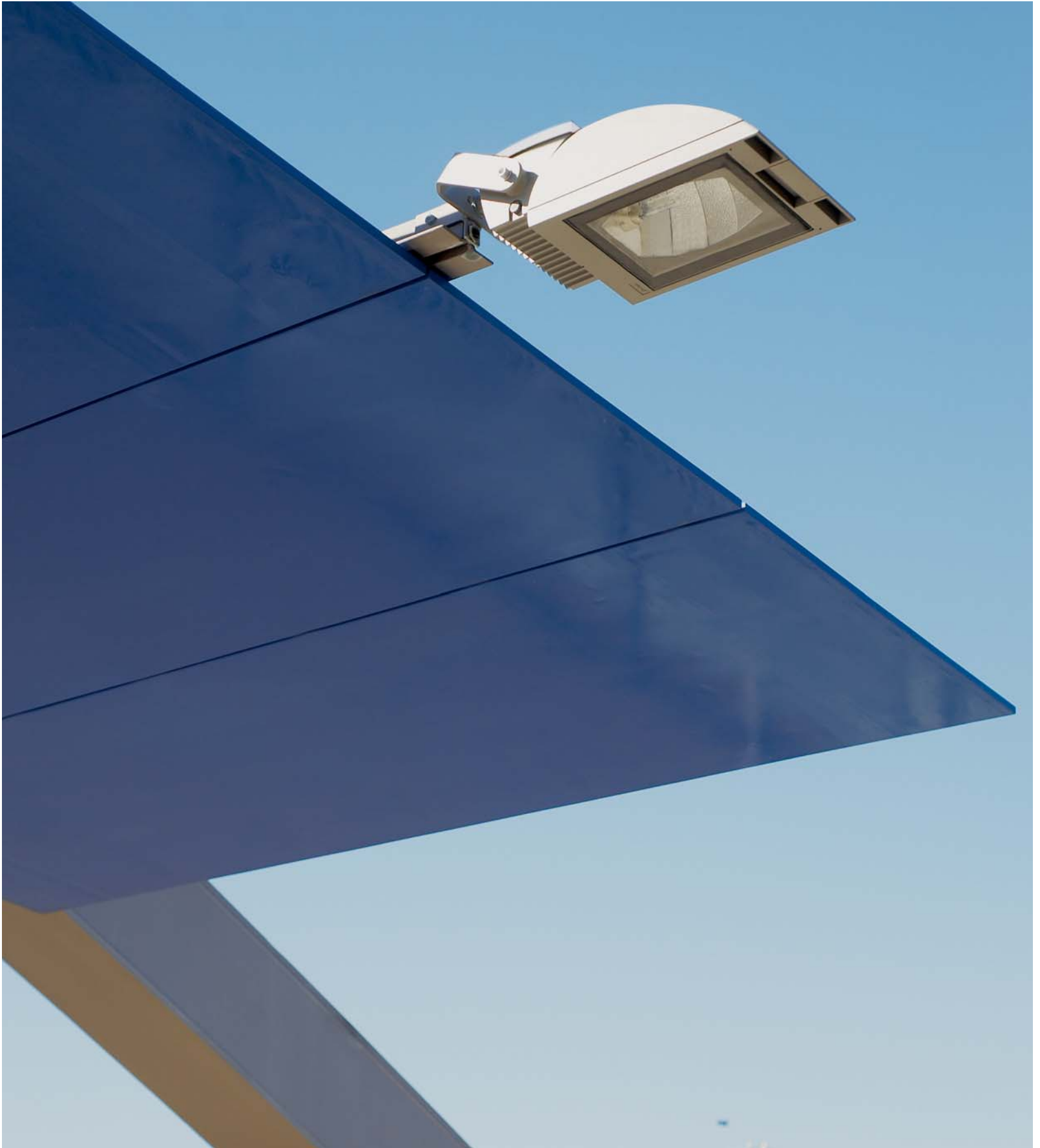

Goodwill Bridge. Brisbane (AUS). Architect: Cox Rayner Architects. Lighting design: Webbs Australia.

OPTICAL ACCESSORIES – FLA400 SERIES

A maximum of one internal optical accessory.



Rearward cut-off shield

for [S] version, with side throw distribution.

for FLA440	108-9264
------------	----------

for FLA460	108-9810
------------	----------



Rearward cut-off shield

for [A] version, with forward throw distribution.

included in product



Sideways cut-off shield

for [A] version, with forward throw distribution.

for FLA440	108-9268
------------	----------

for FLA460	108-9808
------------	----------



Flood lens

for [S] version, side throw, asymmetric distribution and

for [A] version with forward throw distribution, asymmetric.

for FLA440	108-9260
------------	----------

for FLA460	108-9802
------------	----------

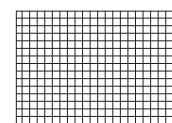

Linear spread lens

for [A] version, forward throw, asymmetric distribution.

for FLA440	108-9262
------------	----------

for FLA460	108-9800
------------	----------

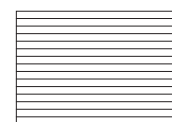

Absorption colour filter

in red, green, blue, yellow.

on request



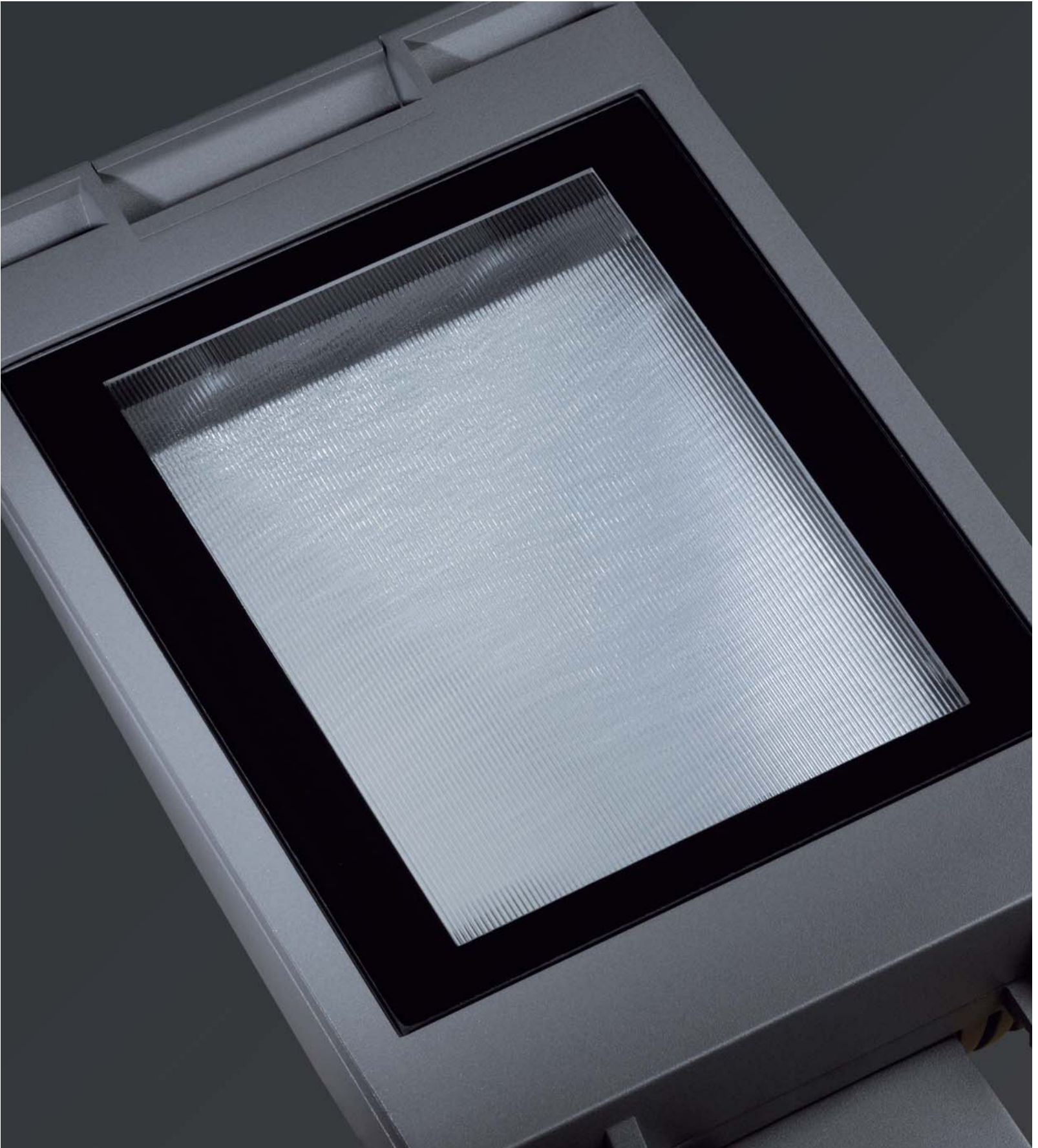

Accessories



ELECTRICAL
■ Gear boxes 372
■ Gear trays 373



ELECTRICAL
■ Surge protection 374



ELECTRICAL
■ Pole accessories 376



ELECTRICAL
■ Cable connecting boxes 377

ELECTRICAL ACCESSORIES

Gear boxes

IP65, Class I. Marine-grade die-cast aluminium alloy. 5CE superior corrosion protection including PCS hardware. Powdercoat finish in RAL 9004, RAL 9006, RAL 9007 or RAL 9016. Two cable glands. Additional cable glands on request.

Enclosure only		A	B	C	kg
400-0003	DK1A	180	125	110	1.2
400-0021	DK2A	230	160	140	1.8
400-0065	DK4A	250	230	170	2.9
400-0080	DK5	290	250	140	3.4
400-0092	DK5A	290	250	220	3.9
400-0140	DK6A	475	290	220	7.0

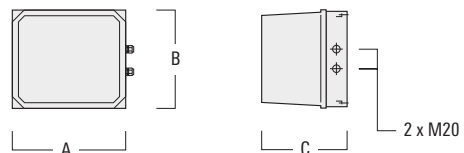

High power factor (HPF)		A	B	C	kg	
400-0033	DK1A for HI 70 W*	~ 230V / 1.00A	180	125	110	2.7
400-0259	DK1A for HS-I 70 W	~ 230V / 1.00A	180	125	110	2.7
400-0261	DK1A for HS-E 70 W*	~ 230V / 1.00A	180	125	110	2.6
400-0018	DK2A for HI 100 W*	~ 230V / 1.10A	230	160	140	3.3
400-0053	DK2A for HS 100 W*	~ 230V / 1.10A	230	160	140	3.3
400-0035	DK2A for HI 150 W*	~ 230V / 1.80A	230	160	140	3.9
400-0056	DK2A for HS 150 W*	~ 230V / 1.80A	230	160	140	3.9
400-0037	DK4A for HI 250 W*	~ 230V / 3.00A	250	230	170	6.2
400-0075	DK4A for HS 250 W*	~ 230V / 3.00A	250	230	170	6.2
400-0042	DK4A for HI/HS 400 W*	~ 230V / 4.00-4.40A	250	230	170	9.1
400-0046	DK5A for 2 HI/HS 400 W*	~ 230V / 2 x 4.00-4.40A	290	250	22	13.0
400-0058	DK5A for HS 600 W*	~ 230V / 6.20A	290	250	220	11.1
400-0121	DK5A for HI 1000 W*	~ 230V / 9.30-9.60A	290	250	22	13.4
400-0126	DK5A for HS 1000 W*	~ 230V / 10.30A	290	250	22	13.
400-0271	DK6A for HI 2000 W*	~ 400V / 9.60-11.30A	475	290	220	19.1



DK5A



* Lamp requires ignitor

Gear trays

IP20, Class I. Gear tray, made from galvanised steel, for mounting in poles.

Pre-wired excluding ignitor with 1 or 2 fuses D01 16A.

High power factor (HPF)				A	B	kg
400-0301	PT110	for HI 1000 W*	~ 230V / 9.30-9.60A	500	145	10.9
400-0319	PT110	for HS 600 W*	~ 230V / 6.20A	500	145	8.4
400-0173	PT110	for HS 1000 W*	~ 230V / 10.30A	500	145	11.0

with 1 fuse D01

400-0180	PT110	for HI 2000 W*	~ 400V / 9.60-11.30A	500	145	13.6
----------	-------	----------------	----------------------	-----	-----	------

with 2 fuses D01

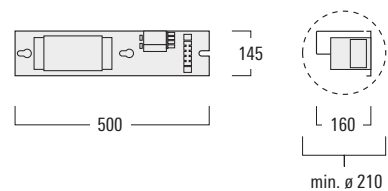

* Lamp requires ignitor

ELECTRICAL ACCESSORIES

Surge protection

WE-EF LED street & area lighting luminaires are fitted with electronic converters featuring 6/6 kV surge protection in accordance with EN 61000-4-5. For comprehensive protection of the luminaire against lightning and electrical surges (high risk areas), primary (type 1) and secondary (type 2) surge arrestors, like the WE-EF SP20, must be installed into the power supply (sub-distributor/switch board). For installations in such high-risk areas, the optional WE-EF SP10 (type 3, 10 kV) surge protection accessory is recommended. If the surge protector has been triggered, the luminaire is automatically disconnected from the mains.

The technical planner/installer is responsible for the proper selection, sizing and installation of the surge protection modules that must be provided on site.

430-0020	SP10 Integral	for installation in luminaire
405-0124	SP10 Remote	for Eco Step Dim® versions (300 mm access door)
405-0136	SP10 Remote	for Eco Step Dim® versions (400 mm access door)
405-0143	SP20 Remote	for installation in switch board (3xL+N)
405-0144	SP20 Remote	for installation in switch board (1xL+N)



Photo: SP20

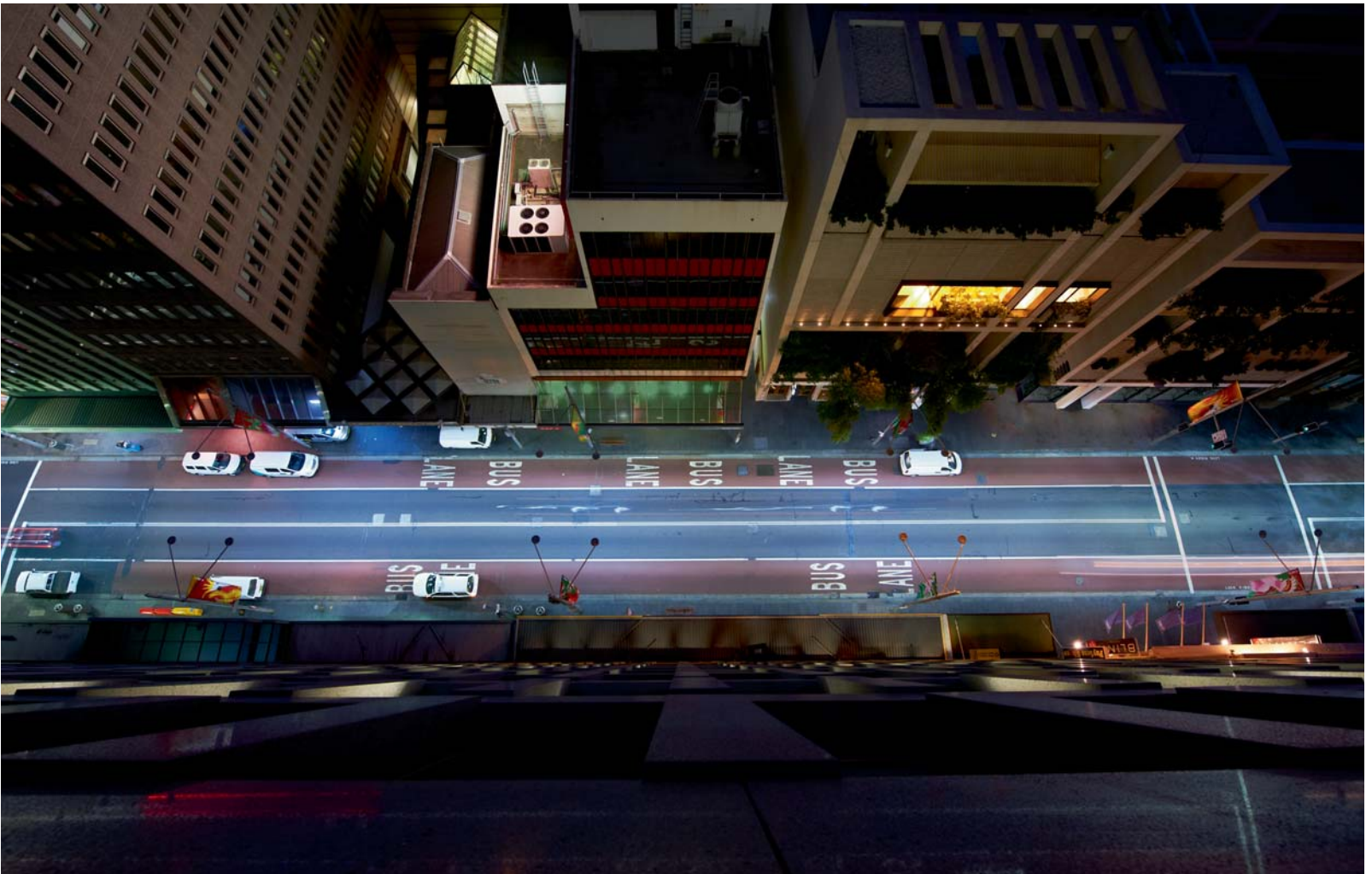

George Street, Sydney (AUS). Planning: Sydney City Council.

ELECTRICAL ACCESSORIES

Pole accessories

IP54. Class I. Recessed socket for poles, made from marine-grade die-cast aluminium alloy. Suitable for bollards and poles. Specify installation requirements when ordering.

Schuko			A	B	D	kg
405-0025	SD1	~ 230V / 16.00A	95	70	∅ 76	0.35
405-0026	SD1	~ 230V / 16.00A	95	70	∅ 89	0.35
405-0028	SD1	~ 230V / 16.00A	95	70	∅ 108	0.35
405-0033	SD1	~ 230V / 16.00A	95	70	∅ 133	0.35
405-0035	SD1	~ 230V / 16.00A	95	70	∅ 160	0.35

C E E

405-0032	SD10	~ 230V / 16.00A	95	70	∅ 108	0.35
405-0088	SD10	~ 230V / 16.00A	95	70	∅ 160	0.35

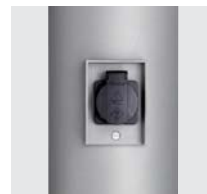

SD1

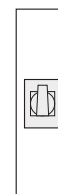
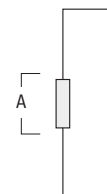

┌ B ┐
└ D ┘

Pole accessories

IP54. Class I. Recessed switch for poles, made from marine-grade die-cast aluminium alloy. Suitable for bollards and poles. Specify installation requirements when ordering.

Schuko			A	B	D	kg
405-0039	SA1	~ 230V / 16.00A	95	70	∅ 76	0.35
405-0040	SA1	~ 230V / 16.00A	95	70	∅ 89	0.35
405-0041	SA1	~ 230V / 16.00A	95	70	∅ 108	0.35
405-0042	SA1	~ 230V / 16.00A	95	70	∅ 133	0.35
405-0043	SA1	~ 230V / 16.00A	95	70	∅ 160	0.35



SA1

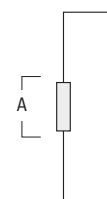

┌ B ┐
└ D ┘

Cable connecting boxes

EK70: IP55, Class II.

EK80 / EK82 / EK93: IP54, Class II.

Cable connecting box for installation inside poles to DIN VDE 0660 and DIN 43628.

Made from fibreglass and UV stabilized polycarbonate. Flame retardent to UL 94-V2 and UL94-V0. Terminal clamps made from corrosion-resistant non-ferrous materials, one level and lockable. Cable grip and finger touch protection.

Incoming max. 2 cables 5 x 6 mm², outgoing max. 1 cable 3 x 2.5 mm², 1 fuse D01, internal pole diameter 70 mm.

405-0078 EK70 Access door min. 85 x 150

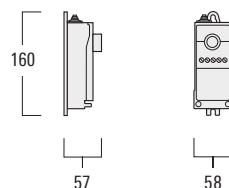

Cable connecting box EK70

Incoming max. 3 cables 5 x 10 mm² or 2 cables 5 x 16 mm², outgoing max. 2 cables 5 x 2.5 mm², 2 fuses D01, internal pole diameter 89 mm.

405-0112 EK80 Access door min. 85 x 300

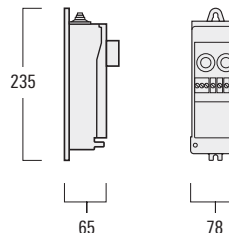

Cable connecting box EK80

Incoming max. 3 cables 5 x 16 mm², outgoing max. 2 cables 5 x 2.5 mm², 2 fuses D01, internal pole diameter 89 mm.

405-0113 EK82 Access door min. 90 x 300

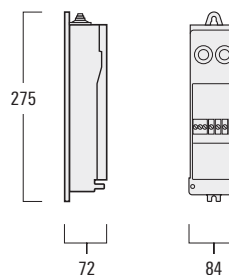

Cable connecting box EK82

Incoming max. 3 cables 5 x 16 mm², outgoing max. 2 cables 5 x 2.5 mm², 3 fuses D01, internal pole diameter 89 mm.

405-0142 EK93 Access door min. 85 x 400

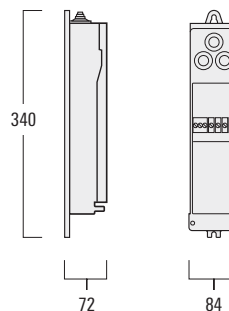

Cable connecting box EK93

Poles

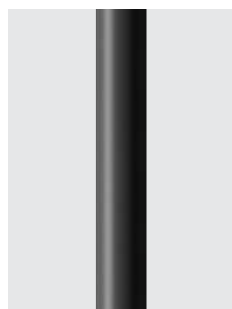

Poles
Galvanised steel,
constant section

■ AM-Z 380



Poles
Wood and galvanised steel,
constant section

■ AMW-Z 382



Poles
Galvanised steel,
tubular, formed stepped

■ AM-R 384



Poles
Galvanised steel,
tubular, stepped

■ AM-S 386
■ AM-S-B 387

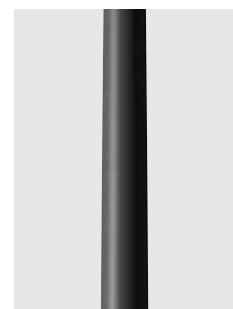

Poles
Galvanised steel,
tapered, seamless

■ AM-K 388
■ AM-K-K 389



Poles
Aluminium,
tapered

■ AML-K 390



Poles
Galvanised steel,
tapered, curved

■ AM-V 392



Floodlighting Poles
Galvanised steel,
tapered

■ FM-K 394

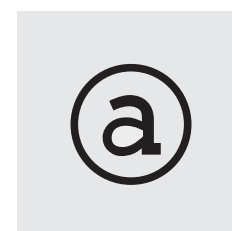

Accessories
■ Mounting

396

AM-Z POLE SERIES

Tubular steel, constant section. Hot dipped galvanised inside and out.

Chrome-free conversion coating with superior powdercoat finish in RAL colour.

Including spigot.

Service door with stainless locking screw. Suitable for one cable connecting box.

Please specify RAL colour reference number according to the WE-EF RAL Colour Chart.

Standard version with planted root and cable entry hole with cable protection.

Special version with surface mounting flange plate is available on request.

For mounting bracket (ø 76 x 80)

		T	H	E	D2	kg
AM-Z 30	250-0089	85 x 300	3000	600	102	28.0
AM-Z 35	250-0099	85 x 300	3500	700	102	34.0
AM-Z 40	250-0091	85 x 300	4000	800	102	39.0
AM-Z 50	250-0628	85 x 300	5000	800	102	48.0

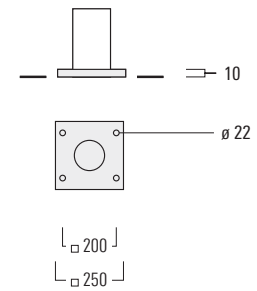
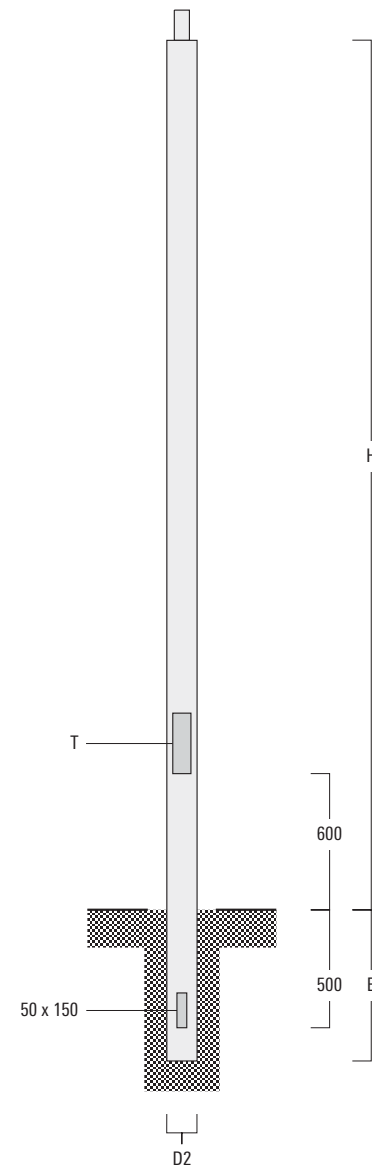

Special version with surface mounting flange plate for H: ≤ 5000 on request

For mounting bracket (ø 76 x 80) and spigot (ø 76 x 80 or ø 102 x 80)

		T	H	E	D2	kg
AM-Z 25	250-0543	90 x 400	2500	600	152	47.8
AM-Z 35	250-0545	90 x 400	3500	700	152	63.8
AM-Z 45	250-0547	90 x 400	4500	700	152	79.9
AM-Z 55	250-0549	90 x 400	5500	800	152	94.4
AM-Z 65	250-0551	90 x 400	6500	1000	152	112.0
AM-Z 75	250-0553	90 x 400	7500	1200	152	129.0

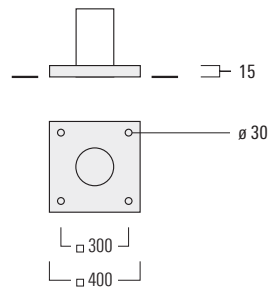
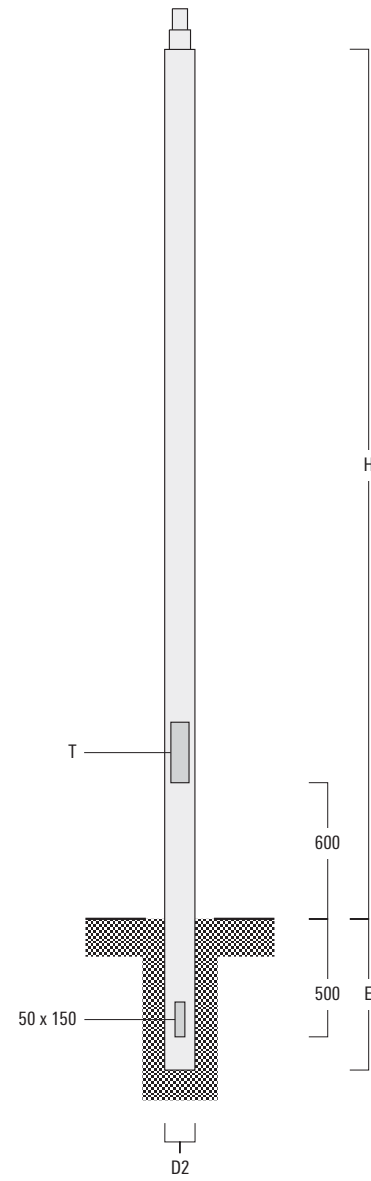

Special version with
surface mounting flange plate
for H: > 5000
on request

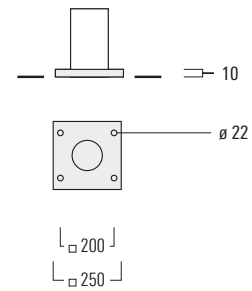

Special version with
surface mounting flange plate
for H: ≤ 5000
on request

AMW-Z POLE SERIES

Mahogany veneer, natural finish and oil-impregnated. Base and inner section tubular steel, hot dipped galvanised inside and out. Chrome-free conversion coating with superior powdercoat finish in RAL colour. Including spigot.

Service door with stainless locking screw. Suitable for one cable connecting box.

Standard version with planted root and cable entry hole. Special version with surface mounting flange plate is available on request.

Please specify RAL colour reference number according to the WE-EF RAL Colour Chart.

Wood is a natural material and therefore susceptible to higher colour and texture variations. Natural ageing is part of the product. We recommend to use a suitable wood stain every 12 months for maintenance and protection.

Special version with surface mounting flange plate on request.

For mounting bracket (ø 76 x 130)

		T	H	E	D2	kg
AMW-Z 25	250-0641	90 x 400	2500	600	152	57.7
AMW-Z 35	250-0642	90 x 400	3500	700	152	76.4
AMW-Z 45	250-0643	90 x 400	4500	700	152	95.0
AMW-Z 55	250-0644	90 x 400	5500	800	152	112.9
AMW-Z 65	250-0645	90 x 400	6500	1000	152	130.0
AMW-Z 75	250-0646	90 x 400	7500	1200	152	145.3

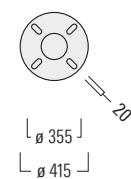
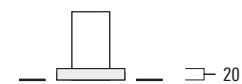
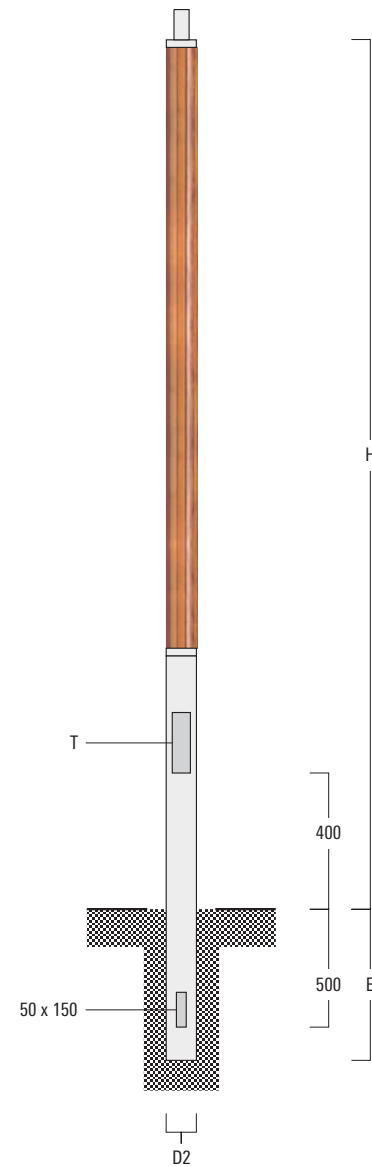

Special version with surface mounting flange plate on request

For mounting bracket (ø 76 x 80) and spigot (ø 76 x 80 or ø 102 x 80)

		T	H	E	D2	kg
AMW-Z 25	250-0488	90 x 400	2500	600	152	57.7
AMW-Z 35	250-0489	90 x 400	3500	700	152	76.4
AMW-Z 45	250-0490	90 x 400	4500	700	152	95.0
AMW-Z 55	250-0491	90 x 400	5500	800	152	112.9
AMW-Z 65	250-0492	90 x 400	6500	1000	152	130.0
AMW-Z 75	250-0513	90 x 400	7500	1200	152	145.3

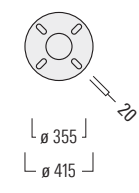
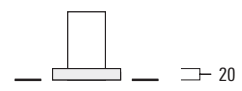
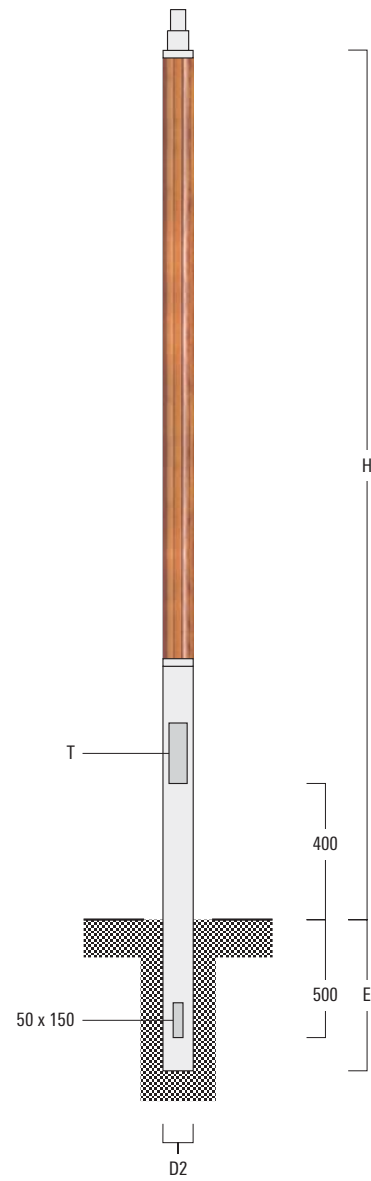

Special version with surface mounting flange plate on request

AM-R POLE SERIES

Tubular steel, one or two formed step. Hot dipped galvanised inside and out.

Chrome-free conversion coating superior powdercoat finish in RAL colour is available up to a maximum length of $H + E < 9.3$ m.

Service door with stainless locking screw. Suitable for one cable connecting box.

Standard version with planted root and cable entry hole.

Please specify RAL colour reference number according to the WE-EF RAL Colour Chart.

Special version with surface mounting flange plate is available on request.

For mounting bracket ($\varnothing 76 \times 80$) and ($\varnothing 76 \times 130$)

		T	H	E	D1	D2	kg
AM-R 30	240-0667	85 x 300	3000	600	76	108	22.0
AM-R 35	240-0381	85 x 300	3500	700	76	108	26.0
AM-R 40	240-0395	85 x 300	4000	700	76	108	30.0
AM-R 45	240-0394	85 x 300	4500	700	76	108	31.0
AM-R 50	240-0696	85 x 300	5000	800	76	108	35.0
AM-R 55	240-0498	85 x 300	5500	800 </td <td>76</td> <td>108</td> <td>40.0</td>	76	108	40.0
AM-R 60	240-0481	85 x 300	6000	800	76	108	43.0

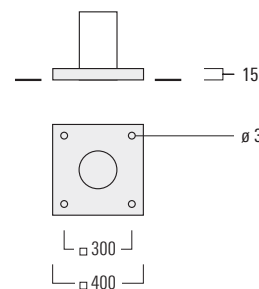
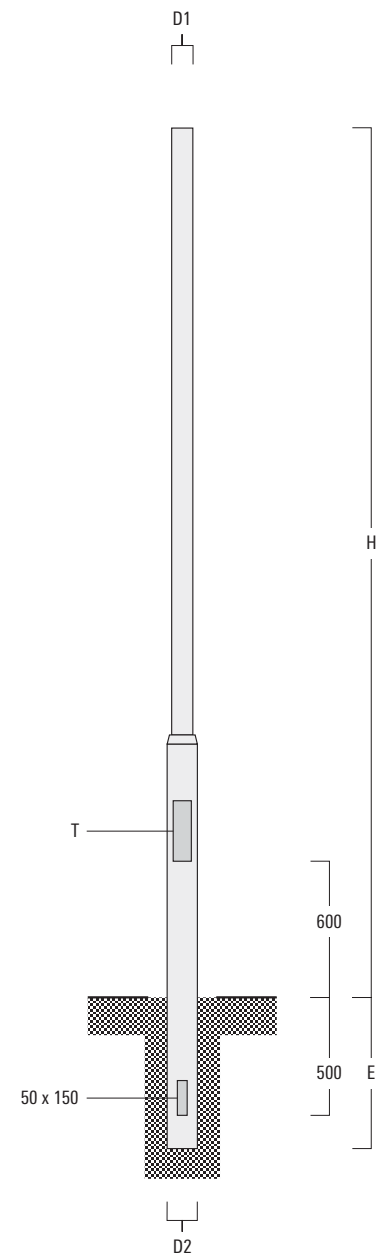

Special version with surface mounting flange plate for $H > 5000$ on request

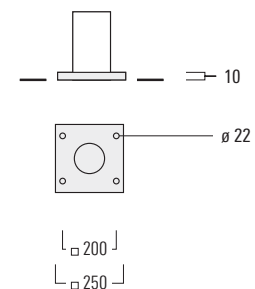

Special version with surface mounting flange plate for $H \leq 5000$ on request

For mounting bracket (ø 76 x 80) and (ø 76 x 130)

		T	H	E	D1	D2	kg
AM-R 65	240-0949	85 x 300	6500	800	76	108	48.0
AM-R 70	240-0731	90 x 400	7000	1000	76	133	65.0
AM-R 75	240-0528	90 x 400	7500	1200	76	133	73.0
AM-R 80	240-0679	90 x 400	8000	1200	76	133	75.0
AM-R 90	240-0104	90 x 400	9000	1400	76	133	88.0
AM-R 100	240-1097	90 x 400	10000	76	133	98.0	

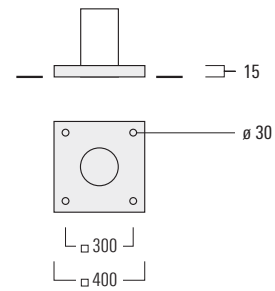
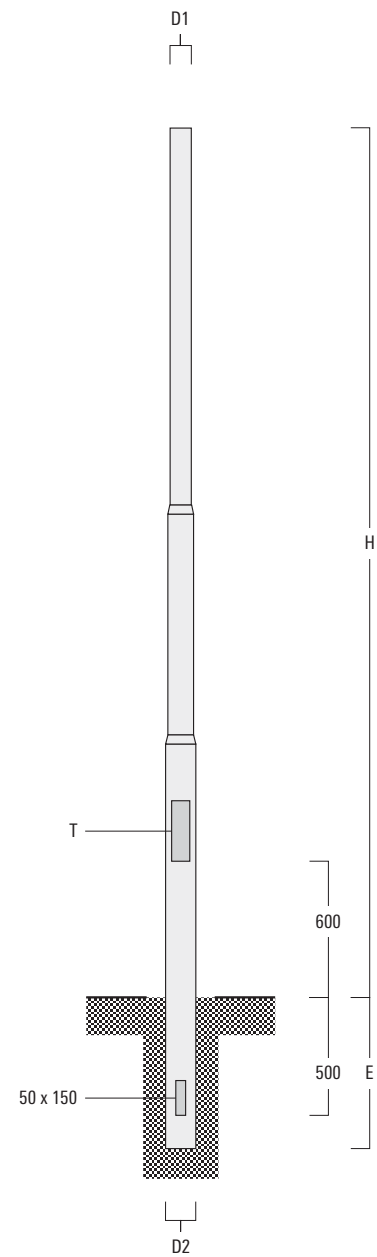

Special version with
surface mounting flange plate
for H: > 5000
on request

AM-S / AM-S-B POLE SERIES

Tubular steel, one step. Hot dipped galvanised inside and out.

Chrome-free conversion coating with superior powdercoat finish in RAL colour.

Service door with stainless locking screw. Suitable for one cable connecting box.

Standard version with planted root and cable entry hole.

Please specify RAL colour reference number according to the WE-EF RAL Colour Chart.

Special version with surface mounting flange plate is available on request.

For mounting bracket (ø 76 x 80) and (ø 76 x 130)

		T	H	E	D1	D2	kg
AM-S 30	240-0584	85 x 300	3000	600	76	108	22.6
AM-S 35	240-0585	85 x 300	3500	700	76	108	26.0
AM-S 40	240-0586	85 x 300	4000	700	76	108	30.0
AM-S 45	240-0587	85 x 300	4500	700	76	108	33.4
AM-S 50	240-0588	85 x 300	5000	800	76	108	37.0
AM-S 55	240-0589	85 x 300	5500	800 </td <td>76</td> <td>108</td> <td>41.0</td>	76	108	41.0
AM-S 60	240-0590	85 x 300	6000	800	76	108	45.0

For mounting bracket (ø 76 x 80)

		T	H	E	D1	D2	kg
AM-S 30	240-1450	90 x 400	3000	600	89	152	29.0
AM-S 35	240-1451	90 x 400	3500	700	89	152	32.0
AM-S 40	240-1452	90 x 400	4000	700	89	152	35.0
AM-S 45	240-1459	90 x 400	4500	700	89	152	38.0
AM-S 45	240-1453	90 x 400	4500	700	102	152	38.0
AM-S 50	240-1454	90 x 400	5000	800	102	152	46.0
AM-S 55	240-1455	90 x 400	5500	800	102	152	55.0
AM-S 60	240-1456	90 x 400	6000	800	102	152	64.0

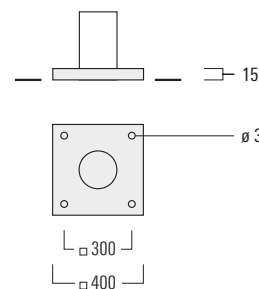
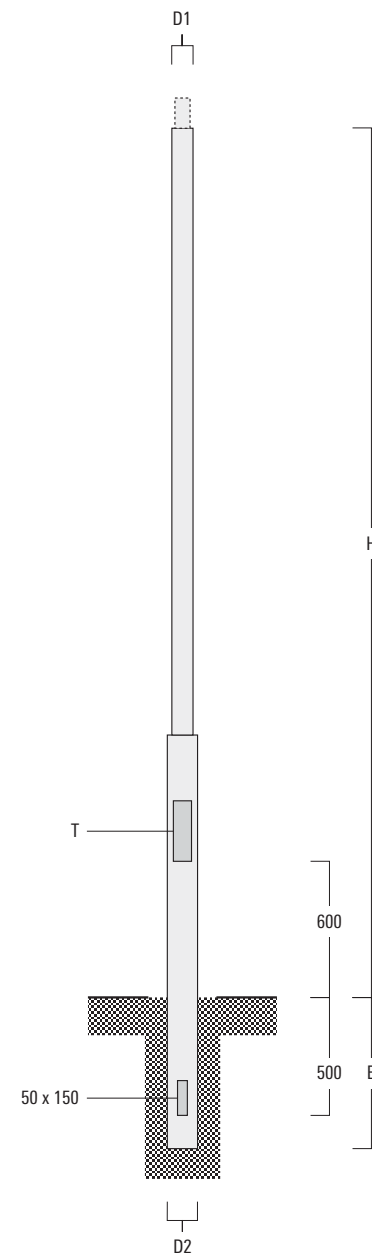

Special version with surface mounting flange plate for H: > 5000 on request

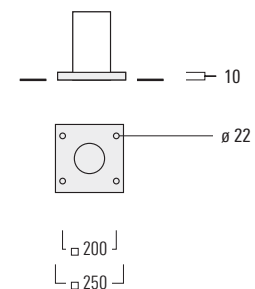

Special version with surface mounting flange plate for H: ≤ 5000 on request

For mounting bracket BC1

		T	H	E	D1	D2	kg
AM-S-B1 30	240-0594	85 x 300	3000	600	76	108	22.6
AM-S-B1 35	240-0596	85 x 300	3500	700	76	108	26.0
AM-S-B1 40	240-0598	85 x 300	4000	700	76	108	30.0
AM-S-B1 45	240-0600	85 x 300	4500	700	76	108	33.4
AM-S-B1 50	240-0602	85 x 300	5000	800	76	108	37.0
AM-S-B1 60	240-0606	85 x 300	6000	800	76	108	45.0

For mounting bracket BC2

		T	H	E	D1	D2	kg
AM-S-B2 30	240-0595	85 x 300	3000	600	76	108	22.6
AM-S-B2 35	240-0597	85 x 300	3500	700	76	108	26.0
AM-S-B2 40	240-0599	85 x 300	4000	700	76	108	30.0
AM-S-B2 45	240-0601	85 x 300	4500	700	76	108	33.4
AM-S-B2 50	240-0603	85 x 300	5000	800	76	108	37.0
AM-S-B2 60	240-0607	85 x 300	6000	800	76	108	45.0

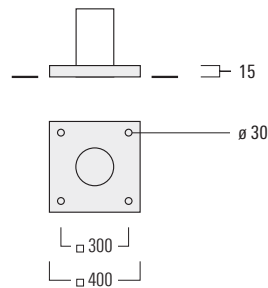
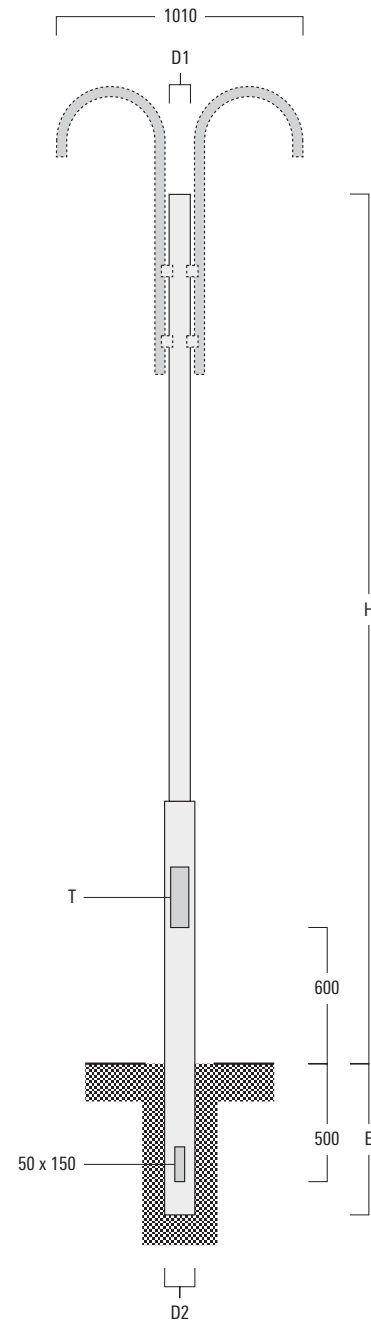

Special version with
surface mounting flange plate
for H: > 5000
on request

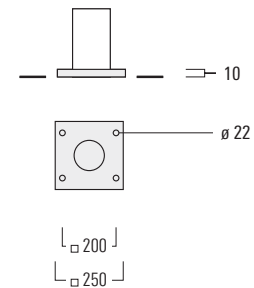

Special version with
surface mounting flange plate
for H: ≤ 5000
on request

AM-K / AM-K-K POLE SERIES

Tubular steel, tapered, seamless. Hot dipped galvanised inside and out.

Chrome-free conversion coating superior powdercoat finish in RAL colour is available up to a maximum length of $H + E < 9.3$ m.

Service door with stainless locking screw. Suitable for one cable connecting box.

Standard version with planted root and cable entry hole.

Please specify RAL colour reference number according to the WE-EF RAL Colour Chart.

Special version with surface mounting flange plate is available on request.

For mounting bracket ($\varnothing 76 \times 80$) and ($\varnothing 76 \times 130$)

		T	H	E	D1	D2	kg
AM-K 30	240-0699	85 x 300	3000	600	76	108	26.0
AM-K 35	240-0484	85 x 300	3500	700	76	108	31.0
AM-K 40	240-0345	85 x 300	4000	800	76	108	35.0
AM-K 45	240-0536	85 x 300	4500	800	76	114	38.0
AM-K 50	240-0659	85 x 300	5000	800	76	114	43.0
AM-K 60	240-0561	90 x 400	6000	1000	76	121	58.0
AM-K 70	240-0627	90 x 400	7000	1200	76	133	79.0
AM-K 75	240-0186	90 x 400	7500	1300	76	133	84.0
AM-K 80	240-0511	90 x 400	8000	1300	76	168	119.0
AM-K 90	240-0200	90 x 400	9000	1400	76	168	135.0
AM-K 100	240-0206	90 x 400	10000	1500	76	168	186.0

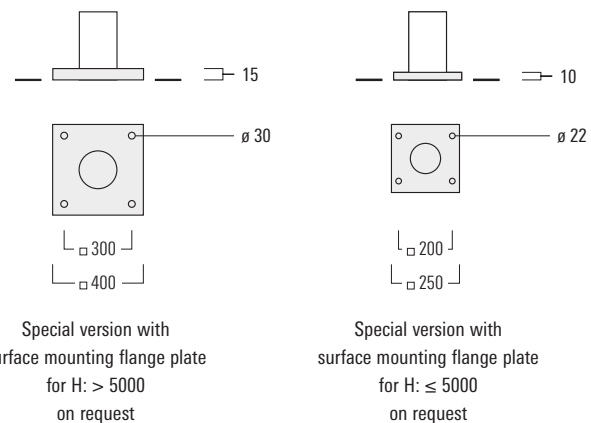
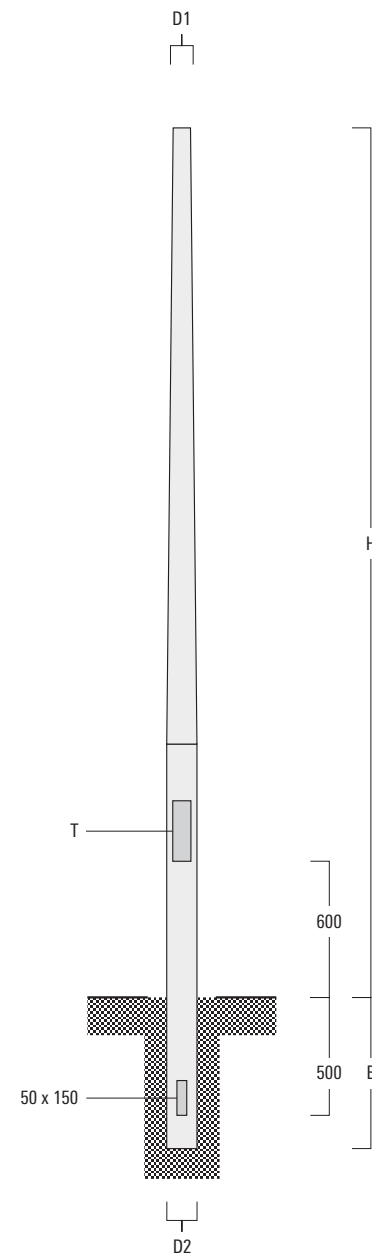

For mounting bracket (ø 76 x 130)

Poles for increased load capacity

		T	H	E	D2	kg													
AM-K-K 40	240-0628	90 x 400	4000	800	133	44.0													
AM-K-K 45	240-0629	90 x 400	4500	800	133	49.0													
AM-K-K 50	240-0630	90 x 400	5000	800	168	75.0													
AM-K-K 60	240-0631	90 x 400	6000	1000	168	91.0													
AM-K-K 70	240-0632	90 x 400	7000	1200	168	105.0													
AM-K-K 75	240-0633	90 x 400	7500	1200	168	113.0													
AM-K-K 80	240-0634	90 x 400	8000	1200	168 </tr <tr> <td>AM-K-K 90</td> <td>240-0635</td> <td>90 x 400</td> <td>9000</td> <td>1400</td> <td>168</td> <td>135.0</td> </tr> <tr> <td>AM-K-K 100</td> <td>240-0636</td> <td>90 x 400</td> <td>10000</td> <td>1500</td> <td>168</td> <td>186.0</td> </tr>	AM-K-K 90	240-0635	90 x 400	9000	1400	168	135.0	AM-K-K 100	240-0636	90 x 400	10000	1500	168	186.0
AM-K-K 90	240-0635	90 x 400	9000	1400	168	135.0													
AM-K-K 100	240-0636	90 x 400	10000	1500	168	186.0													

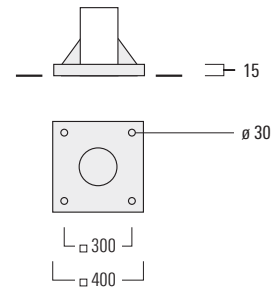
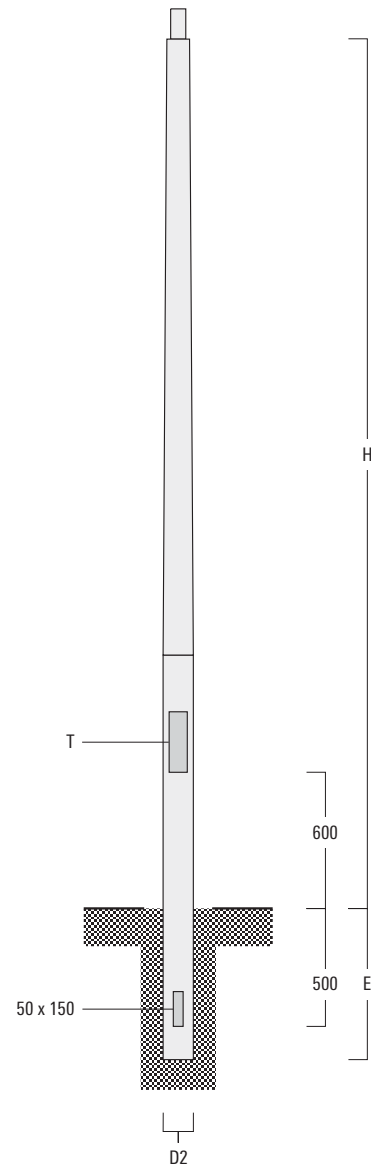

Special version with
surface mounting flange plate
on request

AML-K POLE SERIES

Tubular aluminium, tapered.

Chrome-free conversion coating with superior powdercoat finish in RAL colour.

Specify required spigot dimensions when ordering.

Service door with stainless locking screw. Suitable for one cable connecting box.

Standard version with planted root and cable entry hole with cable protection.

Please specify RAL colour reference number according to the WE-EF RAL Colour Chart.

Special version with surface mounting cast base, for installation to a concrete foundation or to a separate planted root, is available on request.

For mounting bracket (\varnothing 76 x 80) and (\varnothing 76 x 130)

		T	H	E	D1	D2	kg
AML-K 30	240-0221	85 x 400	3000	800	76	114	10.0
AML-K 35	240-0226	85 x 400	3500	800	76	114	11.0
AML-K 40	240-0233	85 x 400	4000	800	76	114	12.0
AML-K 45	240-0238	85 x 400	4500	800	76	114	13.0
AML-K 50	240-0242	85 x 400	5000	900	76	114	15.0
AML-K 60	240-0248	85 x 400	6000	900	76	120	21.0

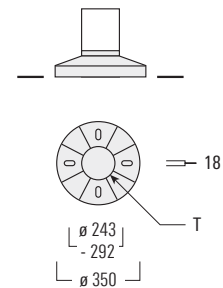
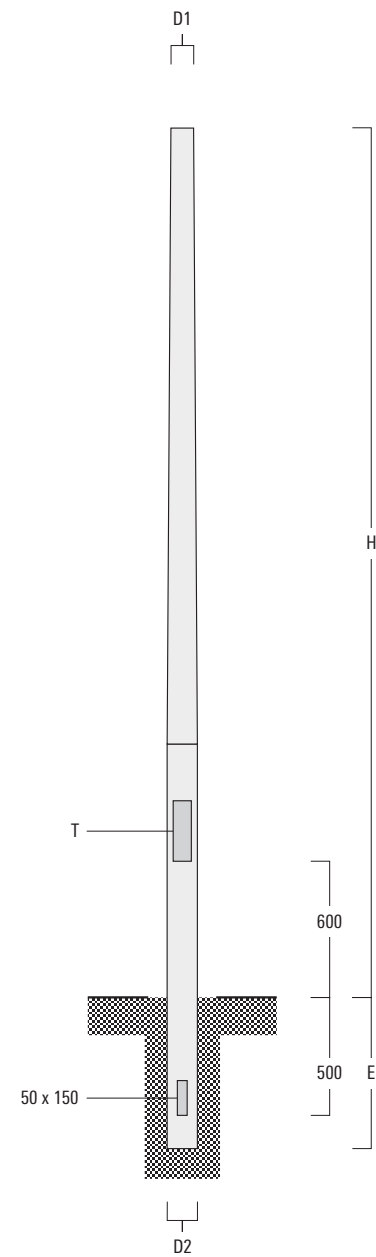

Special version
with cast base
on request



BMW car dealer Riller & Schnauck am Hindenburgdamm, Berlin (D). Planning: Uwe Nüßer, Gebäudemanagement Riller & Schnauck.

AM-V POLE SERIES

Tubular steel, tapered, curved. Hot dipped galvanised inside and out.

Chrome-free conversion coating superior powdercoat finish in RAL colour is available.

Service door with stainless locking screw. Suitable for one cable connecting box.

Standard version with planted root and cable entry hole.

Please specify RAL colour reference number according to the WE-EF RAL Colour Chart.

Special version with surface mounting flange plate is available on request.

For spigot mounted luminaires (ø 42 x 100) or (ø 60 x 100)

		D x L	T	H	E	D2	kg
AM-V 40	240-1149	ø 42 x 100	90 x 400	4000	800	157	83.6
AM-V 40	240-1150	ø 60 x 100	90 x 400	4000	800	157	83.6
AM-V 60	240-1151	ø 42 x 100	90 x 400	6000	1000	191	118.7
AM-V 60	240-1152	ø 60 x 100	90 x 400	6000	1000	191	118.7
AM-V 80	240-1153	ø 42 x 100	90 x 400	8000	1300	223	162.0
AM-V 80	240-1154	ø 60 x 100	90 x 400	8000	1300	223	162.0

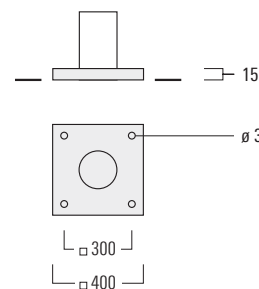
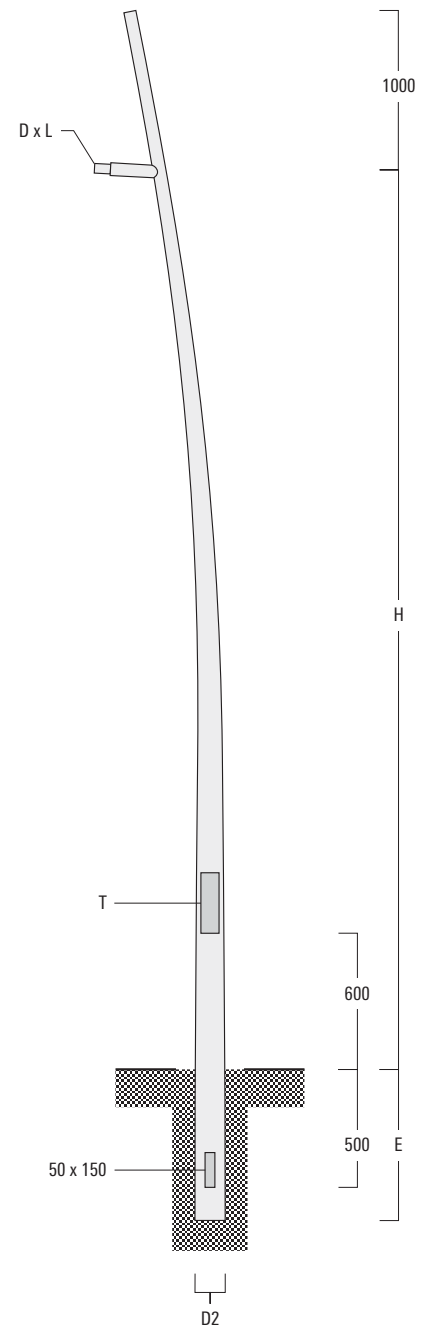

Special version with surface mounting flange plate for H: ≥ 6000 on request

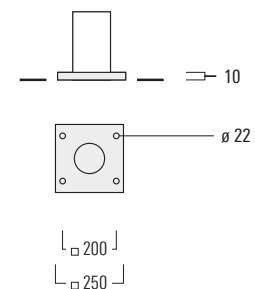

Special version with surface mounting flange plate for H: ≤ 4000 on request



Aller bridge. Celle (D). Lighting design: SSP - Schmitz Schiminski Partner, Hildesheim.

FM-K FLOODLIGHTING POLE SERIES

Tubular steel, tapered. Hot dipped galvanised inside and out.

Standard version with planted root and cable entry hole.

One, two or three service doors, depending on application.

Poles are supplied in two sections for nominal heights of 16 m or above.

Optional climbing rungs from 3 m above ground are available at additional charge.

The maximum windage area is dependant on location.

The maximum permissible number of floodlights require individual calculations.

For mounting brackets (ø 76), (ø 89) or (ø 108)

			T	H	E	D1	D2	kg
FM-K 10	260-0001	1 door	90 x 400	10000	1500	108	223	189.0
FM-K 10	260-0003	2 doors	90 x 400	10000	1500	108	223	189.0
FM-K 12	260-0055	1 door	90 x 400	12000	1500	76	211	198.0
FM-K 12	260-0056	1 door	90 x 400	12000	1500	89	223	221.0
FM-K 12	260-0004	1 door	90 x 400	12000	1500	108	243	247.0
FM-K 12	260-0008	2 doors	90 x 400	12000	1500	108	243	247.0
FM-K 16	260-0013	1 door	140 x 600	16000	1500	108	272	380.0
FM-K 16	260-0015	2 doors	140 x 600	16000	1500	108	272	380.0
FM-K 18	260-0018	1 door	140 x 600	18000	1500	108	292	462.0
FM-K 18	260-0019	2 doors	140 x 600	18000	1500	108	292	462.0
FM-K 18	260-0021	3 doors	140 x 600	18000	1500	108	292	462.0

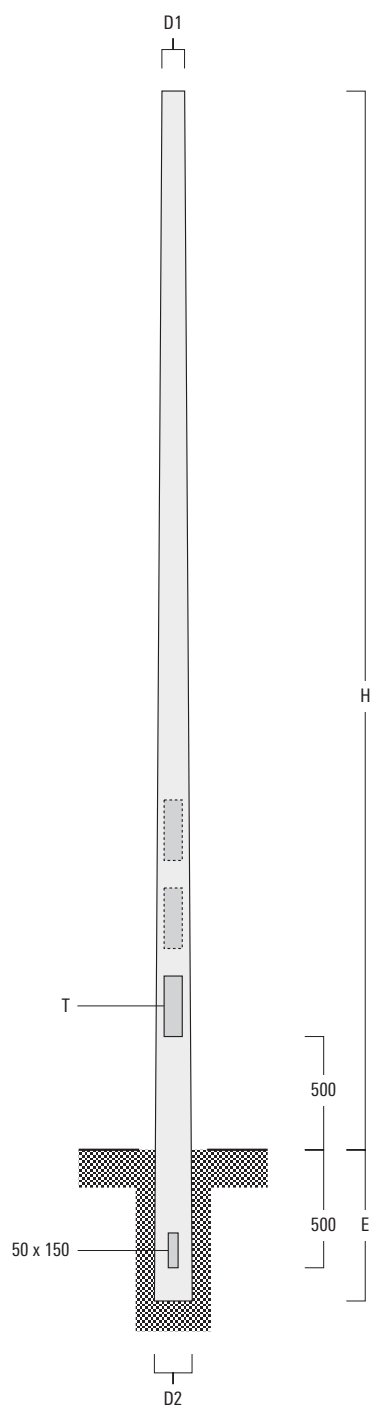

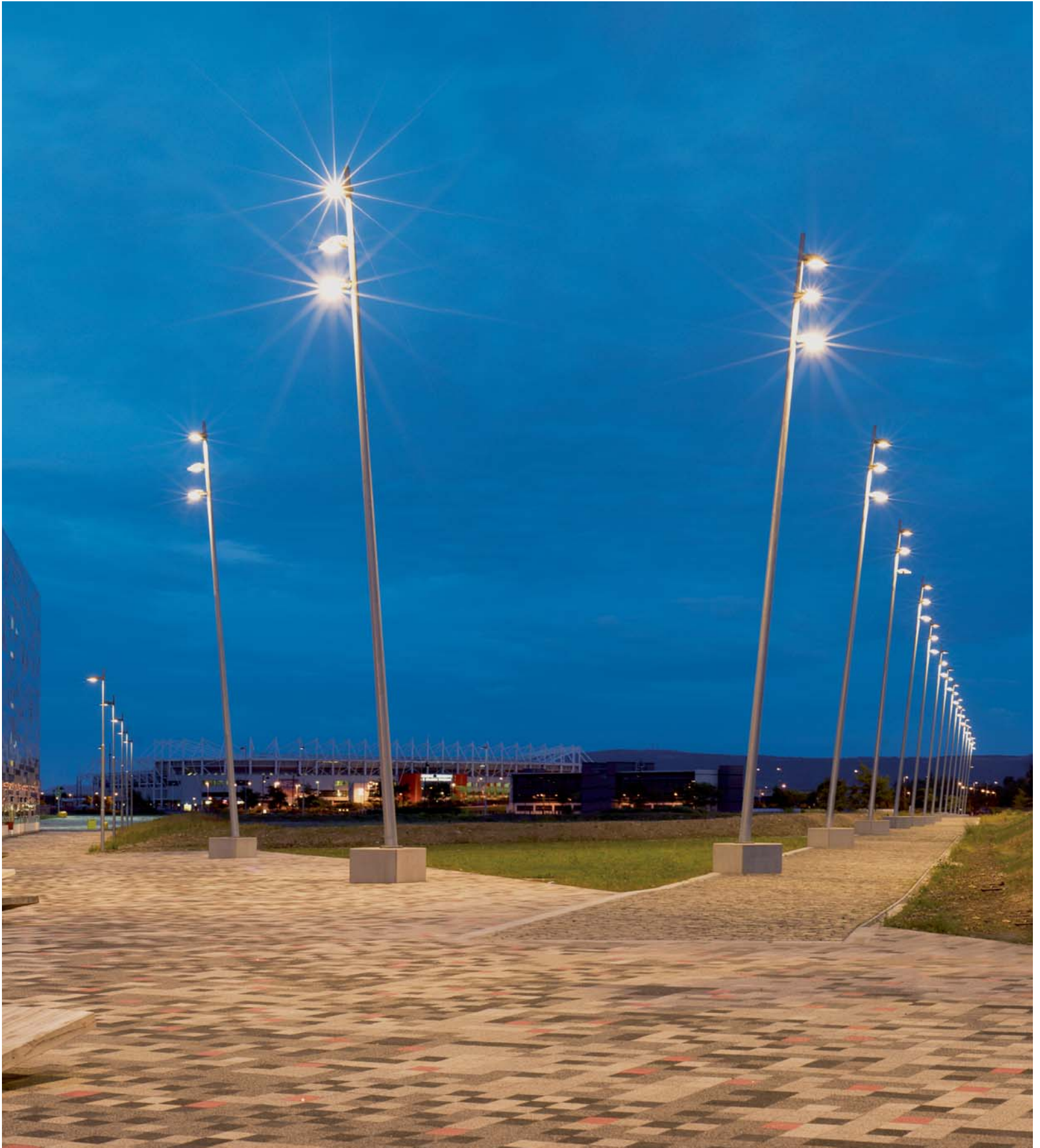

Middlehaven. Middlesbrough (UK). Architect: SMC Alsop/Studio Egret West/FAT. Landscape architect: Grant Associates.

MOUNTING ACCESSORIES

Planted root

for mounting of poles with cast base. Tubular steel, hot dipped galvanised inside and out. Stainless steel hardware.

			kg
ESV6	300-0457	for poles AML-K with D2: > 100	11.2

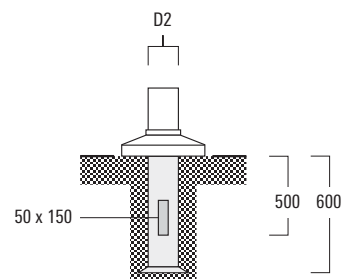

Anti corrosion sleeve

Made from Polyethylene (HDPE), to protect against corrosion of the pole's inground section.

Factory installed component.

KSM100	300-0790	for poles with D2 = 89-114
KSM115	300-0321	for poles with D2 = 120
KSM125	300-0791	for poles with D2 = 133-140
KSM160	300-0325	for poles with D2 = 152-168
KSM200	300-0329	for poles with D2 = 168-219
KSM230	300-0331	for poles with D2 = 220-230
KSM315	300-1019	for poles with D2 = 290-340

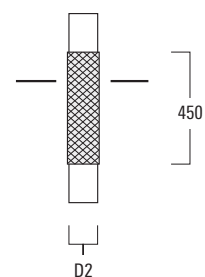

Cable protection

Made from Polyethylene (LDPE), to prevent damage to the underground cable insulation.

KST150	300-0323	for cable entry hole 50 x 150
--------	----------	-------------------------------

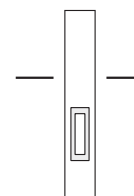

Base plate

Galvanised steel, including fixing hardware.

GP-200	300-0802	A = 200	for poles with D2: ≤ 114: AM-Z, AM-S, AM-S-B, AM-R, AM-K
GP-300	300-0803	A = 300	for poles with D2: > 114: AM-Z, AMW-Z, AM-R, AM-K, AM-K-K, AM-V



Post top fitter

Corrosion resistant aluminium alloy, coated/uncoated. Requires additional 'LS' spigots or 'AV' bracket extensions to mount luminaires.

		kg
AK101	300-0556	2.2
AK102	300-0558	2.5
AK103	300-0559	2.8

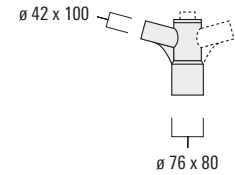

Spigot

Corrosion resistant aluminium alloy or galvanised steel, coated/uncoated, for post top fitter AK.

		D x L	kg
LS42	300-0022	∅ 42 x 100	0.4
LS42	300-0023	∅ 42 x 250	0.7
LS42	300-0358	∅ 42 x 400	1.1
LS60	300-0024	∅ 60 x 100	0.8
LS60	300-0359	∅ 60 x 250	1.4
LS60	300-0360	∅ 60 x 400	1.9

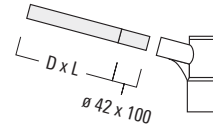

Extension bracket

Galvanised steel, coated/uncoated, for post top fitter AK.

		D x L	L	kg
AV-50	300-0333	∅ 42 x 100	500	2.8
AV-50	300-0336	∅ 60 x 100	500	2.8
AV-80	300-0338	∅ 42 x 100	800	4.1
AV-80	300-0341	∅ 60 x 100	800	4.1
AV-100	300-0343	∅ 42 x 100	1000	5.1
AV-100	300-0345	∅ 60 x 100	1000	5.1
AV-150	300-0353	∅ 42 x 100	1500	7.3
AV-150	300-0355	∅ 60 x 100	1500	7.3

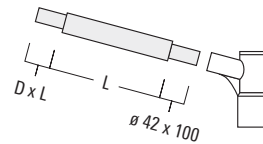
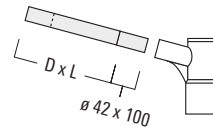

Technical information

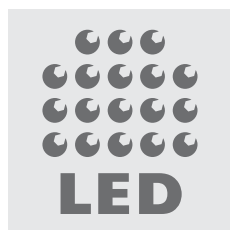

LED Engineering 400

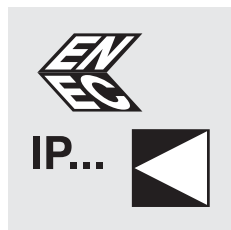

Standards 414

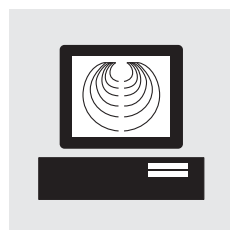

Lighting data and
Project support 418

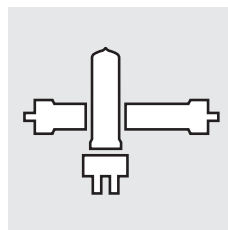

Lamp chart 424

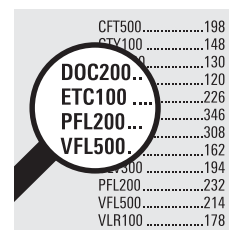

Series index 429

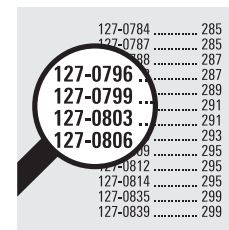

Product index 430

IOS® INNOVATIVE OPTICAL SYSTEM

Supported by an in-house lighting laboratory that develops high-performance innovative optical systems IOS®, WE-EF combines the latest advances in LED technology with specially-designed lenses. When applied to streetlighting, IOS® optimises luminaire spacing while ensuring the best lighting result.

OLC® Technology

WE-EF has taken the unique and critical features of LEDs (e.g., long lifetime) as the basis for OLC® One LED Concept. The current trend in LED streetlighting has the LEDs with either a symmetric or elliptical distribution in order to achieve uniformity. The interaction and overlapping of the beams from the individually-oriented LEDs provides the overall light level and, to some extent, uniform distribution. This standard solution is known as the multi-spot technique. However, WE-EF has moved away from this thinking and adopted, via OLC® technology, the multi-layer principle. Each LED, in combination with the special 'butterfly' lens, illuminates the same area. The sum of all the layers provides a uniform output.

The multi-layer principle has five advantages:

- If one LED fails and the light level drops, uniformity is retained.
- As well as dimming, it is possible to simply switch off individual or groups of LEDs to reduce the light level.
- The system ensures through modular engineering that groups of LEDs can be simply and quickly exchanged. The same linear board system means that when more efficient LEDs become available, they can simply be retrofitted. The photometric performance remains the same.
- OLC® technology has been developed with the future in mind.
- Light is strictly controlled, and any light pollution is kept to an absolute minimum through the exact aiming of the LEDs in combination with the unique 'butterfly' lens.



Standard Solution: Multi Spot



WE-EF Solution: Multi Layer

The OLC® technology (multi-layer principle) is the ideal method for achieving a uniform and energy saving lighting solution, particularly for streetlighting, providing highest safety in ensuring that the failure of individual LEDs does not lead to an adverse affect in the lighting. It balances the needs for safety with visual comfort and energy savings.

[P65] Lens – The advantages of this lens are:

- Optimised for illuminance-based design work (maximum spacing). The 65–70 references the nominal angle of peak intensity from nadir (downward vertical).
- Pedestrian and bicycle lane distribution.
- No light above the horizontal (ILE Class E1/E0). Ideal for pedestrian and bicycle lanes according to the criteria for illuminance EN DIN 13201, Class S2 – S4.

[S60] and [S65] Lenses – The advantages of these lenses are:

- Optimised for luminance-based design work (high visual comfort). The '60' references the nominal angle of peak intensity from nadir (downward vertical).
- Streetlighting distribution.
- No light above the horizontal (ILE CLASS E1/E0). Ideal for streetlighting according to the criteria for luminance EN DIN 13201, Class ME3-ME6. For a one-sided arrangement, guaranteed spacing = $5-5.5 \times \text{MH UI} \geq 0.4$, $T_i < 15$ per cent.

[S70] Lens – The advantages of this lens are:

- Optimised for illuminance-based design work (maximum spacing). The '70' references the nominal angle of peak intensity from nadir (downward vertical).
- Streetlighting distribution.
- No light above the horizontal (ILE CLASS E1/E0). Ideal for streetlighting according to the criteria for illuminance EN DIN 13201, Class S1-S6. For a one-sided arrangement, guaranteed spacing = $7-9 \text{ MH}$ Uniformity $U_0 \geq 0.2-0.4$, with good visual comfort (the norm does not provide specific values for glare limitation).

[A60] and [R65] Lenses – The advantages of these lenses are:

- A comparable performance to conventional asymmetric 'forward throw' HID reflectors.
- Nominal angle of peak intensity through C0 60-65°.
- Rearward spill limited to an angle of 10°.
- No light above the horizontal (ILE CLASS E1/E0). Ideal for lighting public spaces where visual comfort (glare) is a critical factor.

[C50] and [R] Lenses – The advantages of these lenses are:

- Optimised for illuminance-based design work (maximum spacing) with good visual comfort.
- Symmetric and rectangular distribution
- For [C50] maximum angle of peak intensity through C0 50°. For [R] maximum angle peak intensity through C0 65°, C90 45°. The [R] distribution has a forward to side ratio of 1:2. No light above the horizontal (ILE Class E1/E0). Ideal for lighting public spaces where both uniformity and visual comfort are critical factors.

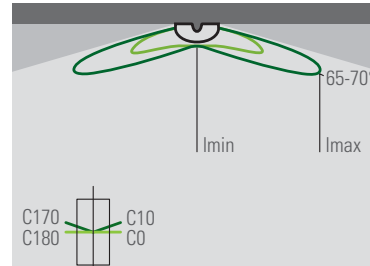

[P65]

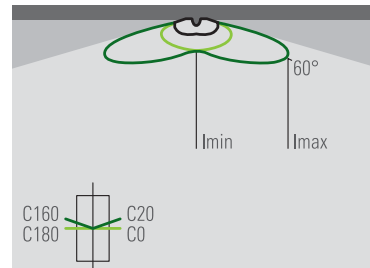

[S60]

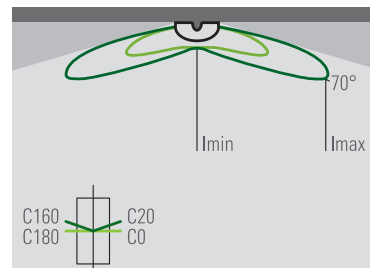

[S70]

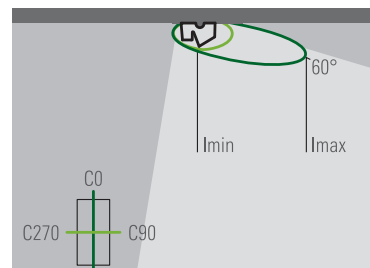

[A60]

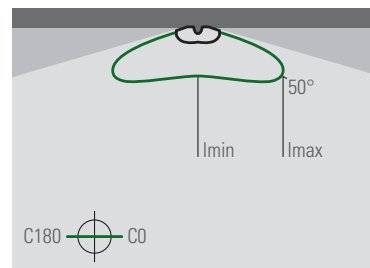

[C50]



IOS® INNOVATIVE OPTICAL SYSTEM

RFC® Technology

RFC® technology is designed to complement the streetlighting versions and it is an important method of further enhancing system performance.

- The conventional flat-glass panel or cover is replaced by a UV-stabilised panel which has a contoured surface, contoured in a way that imitates the shape of the 'butterfly' lens; the goal is to minimise the loss of light that normally occurs due to internal reflection. The RFC® technology is available for the WE-EF lens systems [P65] [S60] [S65] [S70] [A60] [R65] [C50] [R].
- In the case of the [S60] lens, the benefits include the transmission factor at the critical 60° (downwards vertical), which is improved by ~20 per cent. With the [S70] lens, at the critical 70°, the transmission factor is improved by ~30 per cent. As much as 5 per cent will be added to the light output ratio (LOR) of both luminaires.
- In the case of the [S60] lens, this means there is a modest improvement in spacing due to it being a luminance-optimised luminaire. In the case of the [S70] lens, which is optimised for illuminance design work, important increases have been achieved in spacing. This adds to the economic and environmental case favouring the OLC® One LED Concept technology with the special 'butterfly' lens.

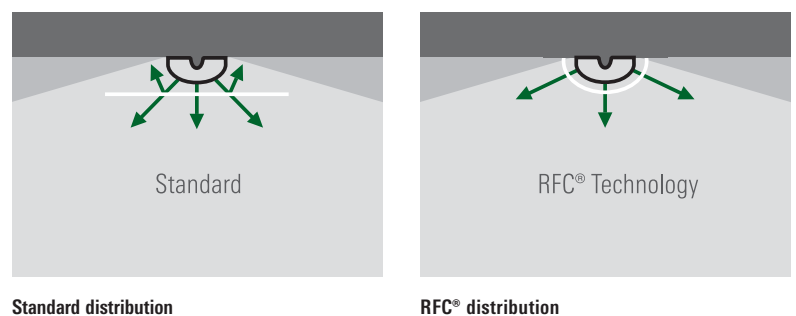

Standard distribution

RFC® distribution



The contour of the cover follows the shape of the lens, thereby minimising the internal reflection within the luminaire caused by the light hitting the cover.

IOS® INNOVATIVE OPTICAL SYSTEM

LED beam distribution

The modular construction of WE-EF LED luminaires makes optimised distribution possible for different lighting solutions.

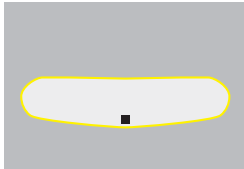

[P65] Pedestrian / bicycle lane distribution. Illuminance optimised lens, based on Class S2-S4 from EN 13201.
Spacing 5 – 7 x mounting height.
Typical mounting height 3 – 5 m.

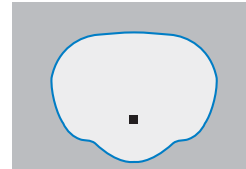

[R65] Rectangular forward throw distribution for lighting public spaces and car parks.
Maximum angle of peak intensity (side and forward) approximately under 65°. Rearward spill limited to an angle of 10°. Typical mounting height 4 m to 8 m.

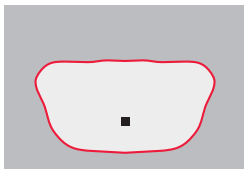

[S60] Streetlighting distribution, luminance-optimised lens, based on Class ME3-ME6 from EN 13201.
Spacing 5 to 5.5 times the mounting height; $T_i < 15$ per cent.
Typical mounting height 3 m to 6 m.

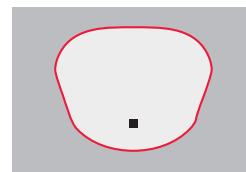

[A60] Asymmetric forward throw distribution for lighting public spaces.
Maximum angle of peak intensity 60°-65°. Rearward spill limited to an angle of 10°. Typical mounting height 4 m to 8 m.

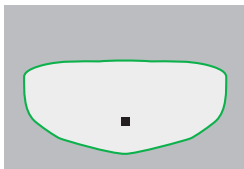

[S65] Streetlighting distribution including intersections and public spaces, luminance-optimised lens, based on Class ME3-ME6 from EN 13201.
Spacing 5 to 5.5 times the mounting height; $T_i < 15$ per cent.
Typical mounting height 6 m to 10 m.

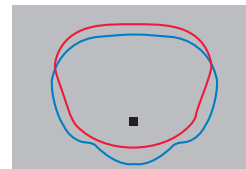

[A60] [R65]
light distributions in comparison

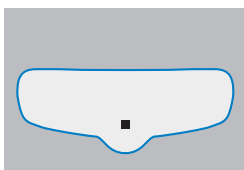

[S70] Streetlighting distribution, illuminance-optimised lens, based on Class S1-S6 from EN 13201.
Spacing 7 to 9 times the mounting height; $T_i < 15$ per cent.
Typical mounting height 3 m to 6 m.

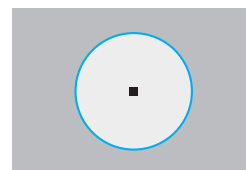

[C50] Symmetric distribution for lighting public spaces and car parks.
Maximum angle of peak intensity approximately 50°. Glare index G1 from EN 13201.
Typical mounting height 4 – 6 m.

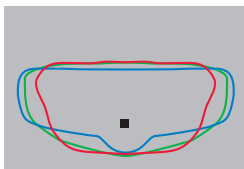

[S60] [S65] [S70]
light distributions in comparison.

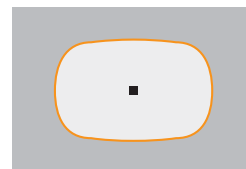

[R] Rectangular distribution for lighting public spaces and car parks.
Maximum angle of peak intensity approximately 45° and 65°. Glare index G1 from EN 13201.
Typical mounting height 4 – 6 m.

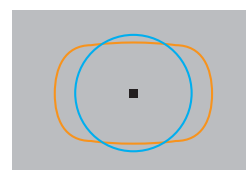

[C50] [R]
light distributions in comparison

LED ENGINEERING

The development of high quality and efficient LED lenses is one of WE-EF's core competencies. WE-EF possesses the expertise for design, engineering and production.

WE-EF is able to apply its expertise gained from a long experience in the development and operation of LEDs. For example, at the SONY Center in Berlin, 12 years ago, WE-EF was involved with one of the first major LED projects. It was an invaluable advantage, both in understanding today's possible LED technology and in converting this knowledge into innovative lighting solutions.

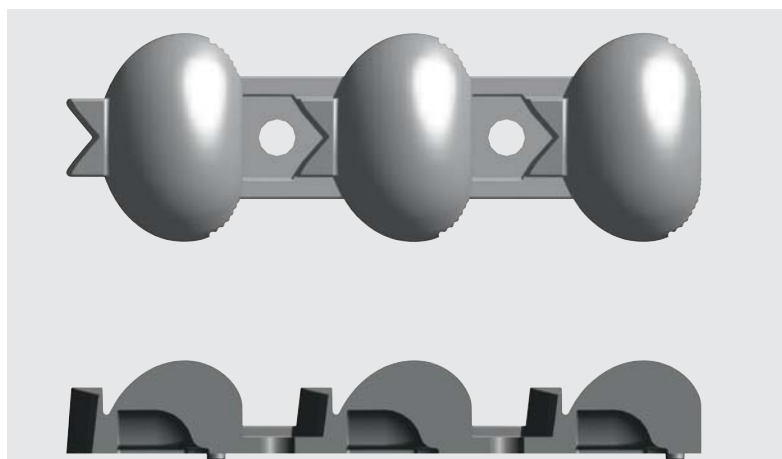

CAD design, optical simulations, prototypes, verification and injection moulding tooling are all used in WE-EF's development and production facilities.

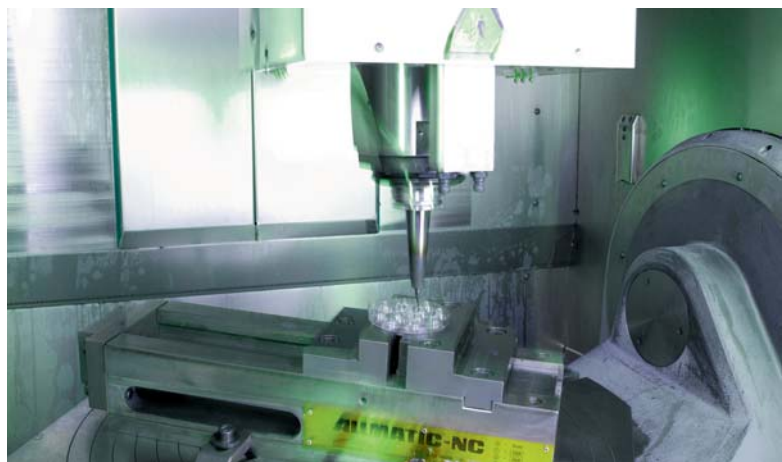

For every LED lens type a prototype is prepared in WE-EF's tooling shop, which is then measured and optimised.

Definitions

The terms and definitions used in this section are based on the document entitled 'Guidelines for project design safety in LED lighting' (Leitfaden Planungssicherheit in der LED-Beleuchtung) as published by the German Electrical and Electronic Manufacturers' Association (ZVEI) in November 2015.

Rated input power P (W): the effective input of a luminaire, comprising the power consumption of all components integrated in the luminaire.

Rated luminous flux Φ_v (lm): the total radiant flux of a luminaire in its visible range, also known as the initial luminous flux.

Luminaire efficacy η_v (lm/W): the quotient of the rated luminous flux and the rated input power.

Rated ambient operating temperature T_a ($^{\circ}\text{C}$): the maximum ambient temperature at which a luminaire can be operated whilst still maintaining all safety-relevant parameters. In this catalogue, $T_a = 25^{\circ}\text{C}$. However, please note that the majority of the



WE-EF LED boards fitted with high-quality LEDs, which have narrowly-defined binning tolerances, guarantee high-visual comfort.

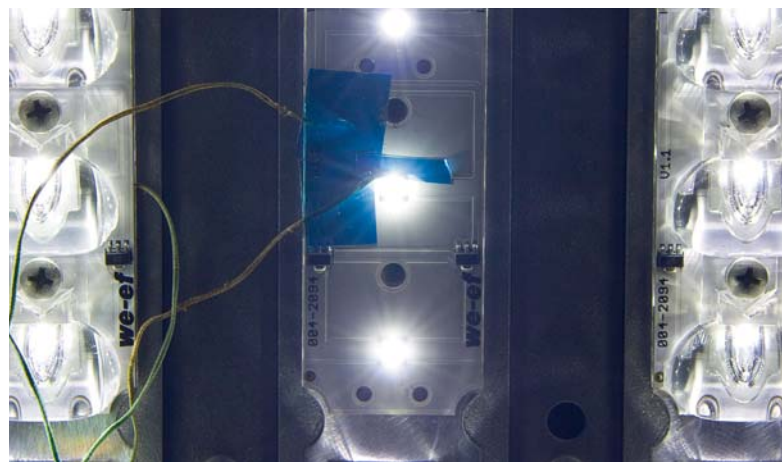

The junction temperature T_j of the LEDs in operation is important for defining lumen depreciation and lifetime.

luminaires listed have a significantly higher rated temperature T_a .
 Contact WE-EF to request data for a particular luminaire.

Rated ambient performance temperature T_q (°C): the maximum ambient temperature at which a luminaire reaches the specified values for luminous flux and service life, for example. All of the data in this catalogue is based on a rated ambient temperature of $T_q = 25^\circ\text{C}$.

Rated service life $L_x B_y$ (h): the number of hours after which

- a) a group of LED luminaires have dropped to a luminous flux of x (%)
- b) a number y (%) of LED luminaires have dropped below the specified luminous flux

Example:

Requirement $L_{70} B_{10} - 60,000$ h means that after 60,000 hours the group of LED luminaires in question must still provide 70% of the initial luminous flux, whereby 10% of the LED luminaires in question are permitted to provide less than 70% of the initial luminous flux.



Using either a 1-10V or DALI interface with electronic converter, the light output and energy usage of the individual luminaires can be controlled.



In all WE-EF luminaires the LED boards can be individually exchanged without special tools.



All components of the luminaire are engineered for reliability and longevity.

LED ENGINEERING

Thermal management

Long service life and maximum efficiency can only be achieved with perfectly coordinated thermal management. WE-EF products discharge the heat generated by the LEDs through the enclosure that contains a built-in heat sink. As part of a first development step, thermal conditions are simulated with the relevant computer programs and optimised at a theoretical level. Once this optimisation process is complete, prototypes are produced for each luminaire, which are then subjected to intensive testing until they provide results that meet the requirements. WE-EF guarantees optimised heat discharge with maximum service life and minimal reduction in luminous flux.

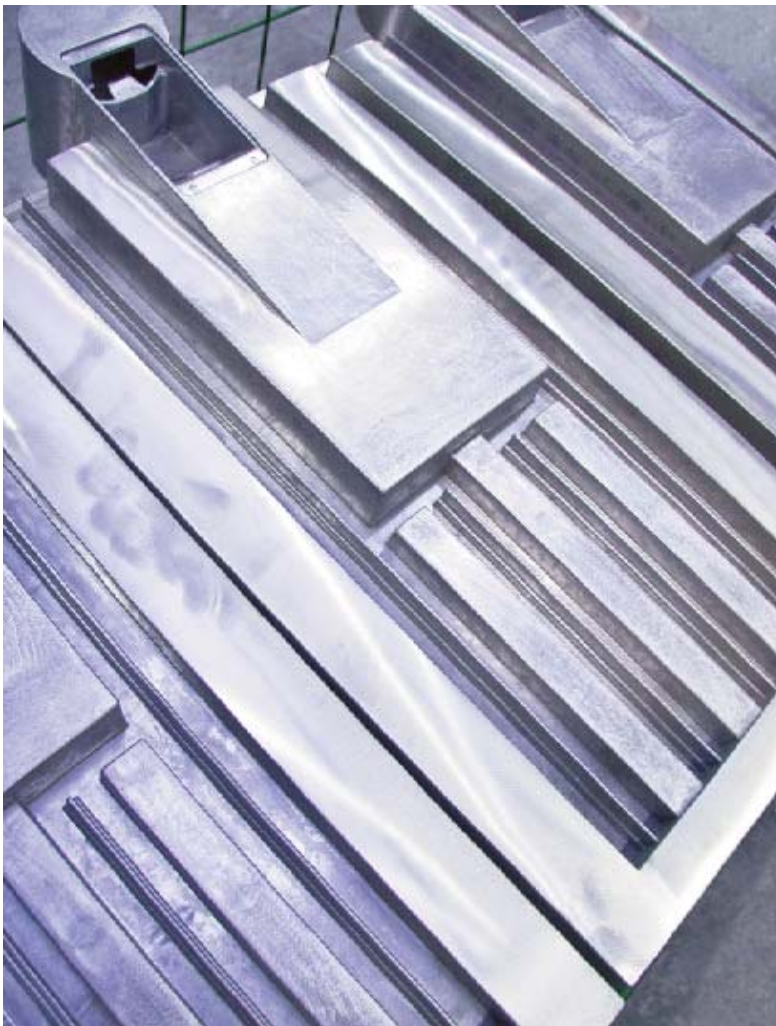

The luminaire housing is made from die-cast aluminium with integrated heat sink. This, in addition to the excellent heat-conducting properties of aluminium, helps to optimise thermal management.



Thermal simulation results are verified using prototypes and actual products before a new luminaire is introduced to the market.

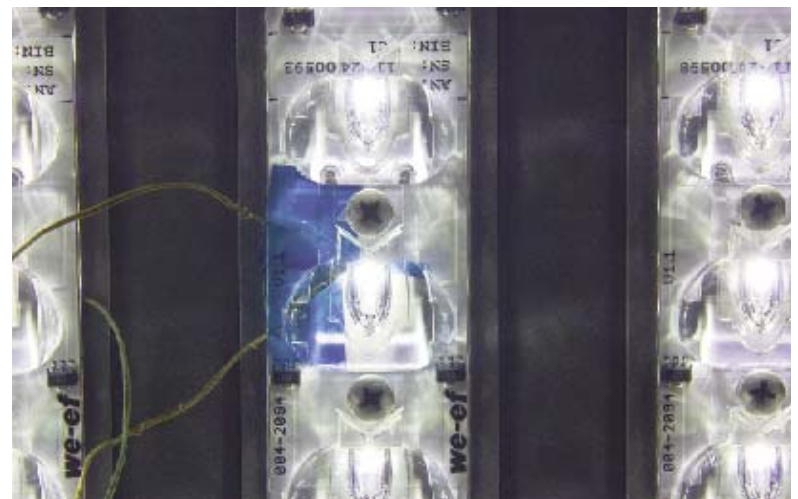

Extensive stress testing is carried out under extreme operating conditions. Products tested in this manner perform exceptionally well under normal field conditions.

LED Lighting Emitting Diodes

As a luminaire manufacturer, WE-EF aims to shape the thermal conditions in the luminaire so as to ensure that the LEDs are operated at the optimum working point and overloads can be avoided. The product data sheets of the LED manufacturers, which are based on the results of tests and mathematical calculations, form the foundation for ensuring that these tasks can be performed successfully. An assessment of whether an LED in a luminaire is operated in an optimum manner and the effects on service life and reduction in luminous flux is much more complex than for conventional lamps, and therefore requires more attention.

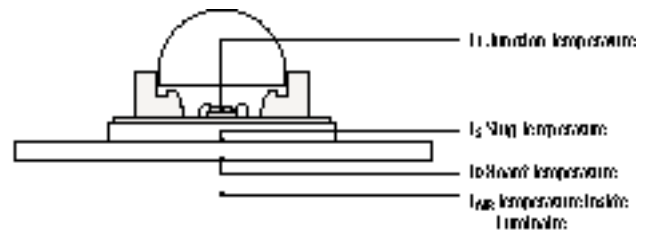

Thermal resistance R_{th}

One of the main focus areas of LED developments in recent years was and is the reduction in thermal resistance $R_{th} = R_{thJS} + R_{thSB} + R_{thBA}$ (resistance between the LED's junction temperature and the temperature on the inside of the luminaire). The smaller the resistance, the smaller the LED's thermal load. This leads to higher luminous flux and reduced ageing, and hence to a longer service life. A luminaire manufacturer can influence thermal resistance by

- developing optimised cooling elements for specific applications,
- guaranteeing clean and level contact surfaces between the LED circuit board and the heat sink, and
- selecting materials with very high thermal conductivity for the LED circuit boards, for example aluminium or ceramics. Circuit boards made of plastics are not suitable in this context.

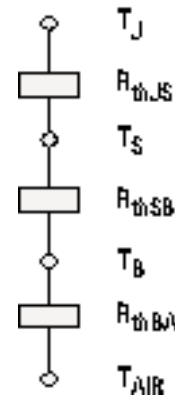

LED ENGINEERING

Operating current I_f

LEDs can be operated with a variety of currents. While at present currents range between 350 mA, 500 mA, 700 mA and 1,050 mA, there is also a development trend towards 1,400 mA and up to 4,000 mA. The higher the operating current, the higher the luminous flux. Unfortunately, LEDs also feature a declining operating current/luminous flux characteristic line. In other words, increases in operating current are accompanied by disproportionately low increases in luminous flux, and luminaire efficacy (lumen/watt) also decreases. The ideal situation is a proportional linear relationship between operating current and luminous flux.

The non-linearity between operating current and luminous flux increases as the temperature of the junction temperature (T_j) increases.

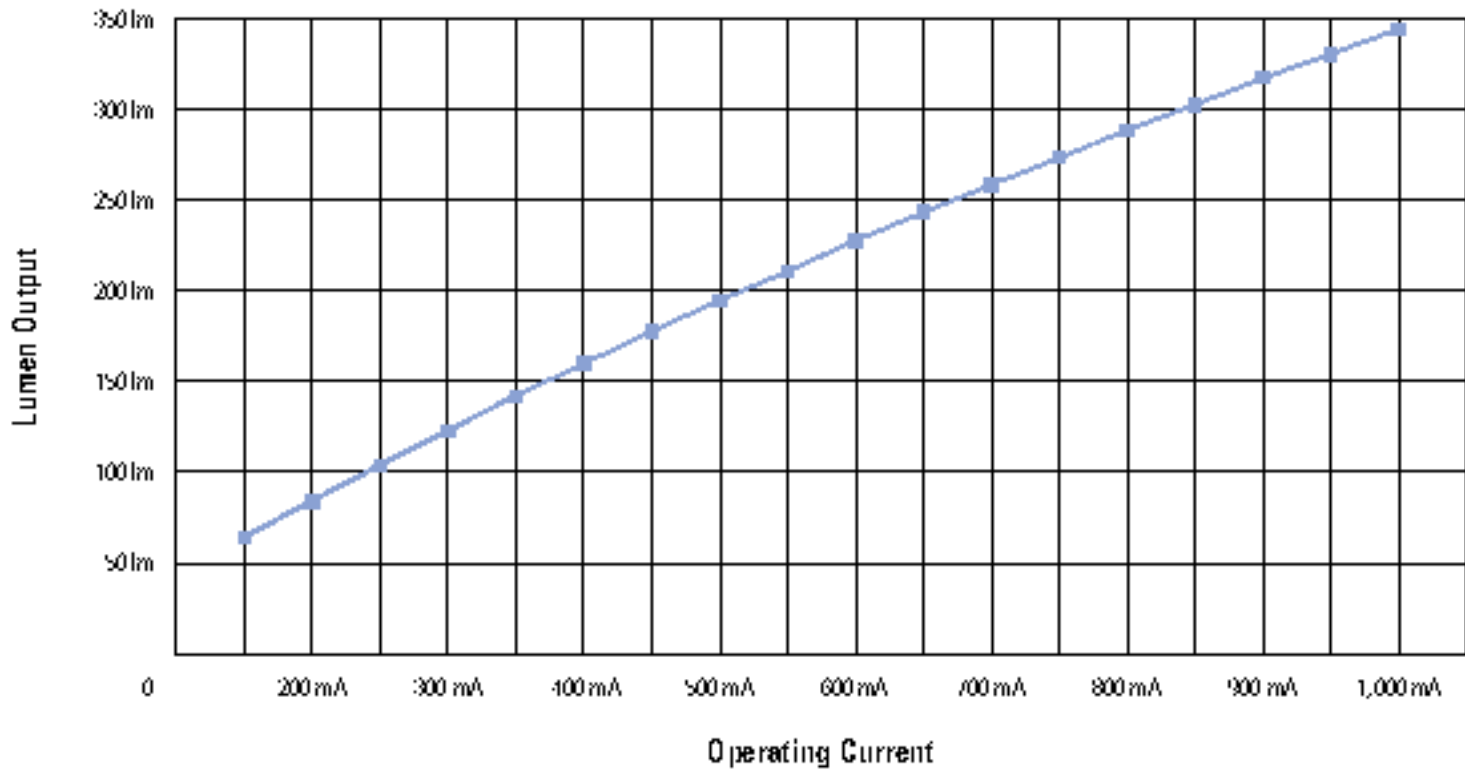

Service life and junction temperature T_J

The service life information provided by LED manufacturers is based on measurements pursuant to LM-80-08 (minimum testing 6,000 h). By combining these measurement values with mathematical calculation models according to TM-21, it is possible to make statements about the behaviour of LEDs during a significantly larger time frame. Today, it is possible to expect a rated service life according to TM-21 of up to 6 times the measured time period. This calculation can be used as a basis to extrapolate a service life curve and draw conclusions regarding the expected service life.

(It is now up to the luminaire manufacturer to transfer these results to the luminaires, which in turn requires them to conduct extensive testing on their luminaires.)*

The service life indications that are derived from this process are based on certain assumptions, which must be clearly documented. Information on the following is required:

- Maximum rated ambient performance temperature (T_a);
- Operating current (I_f);
- Service life L_xB_y

If for example the average rated ambient performance temperature T_a is 30°C (basis $T_a = 25^\circ\text{C}$) for an application, then the so-called junction temperature T_J will also increase by the difference ($30^\circ\text{C} - 25^\circ\text{C}$).

The junction temperature T_J is different for each luminaire, depending on system performance and operating current. This temperature is a maximum of 85°C on average for all of the luminaires shown in this catalogue, which are fitted with the maximum number of LEDs and are operated with 700 mA at an average rated ambient performance temperature of 25°C .

LEDs also undergo an ageing process similar to conventional lamps, i.e. the initially available rated luminous flux decreases the longer the LED is in operation. The lower the LED's thermal load, the lower the reduction in luminous flux. The diagram below illustrates the dependency of an LED's luminous flux on the service life and the average rated ambient performance temperature at an operating current of 700 mA. The diagram below can be used to calculate the luminous flux that can be expected after a certain operating period.

* WE-EF data is based on continual testing for at least 10,000 h

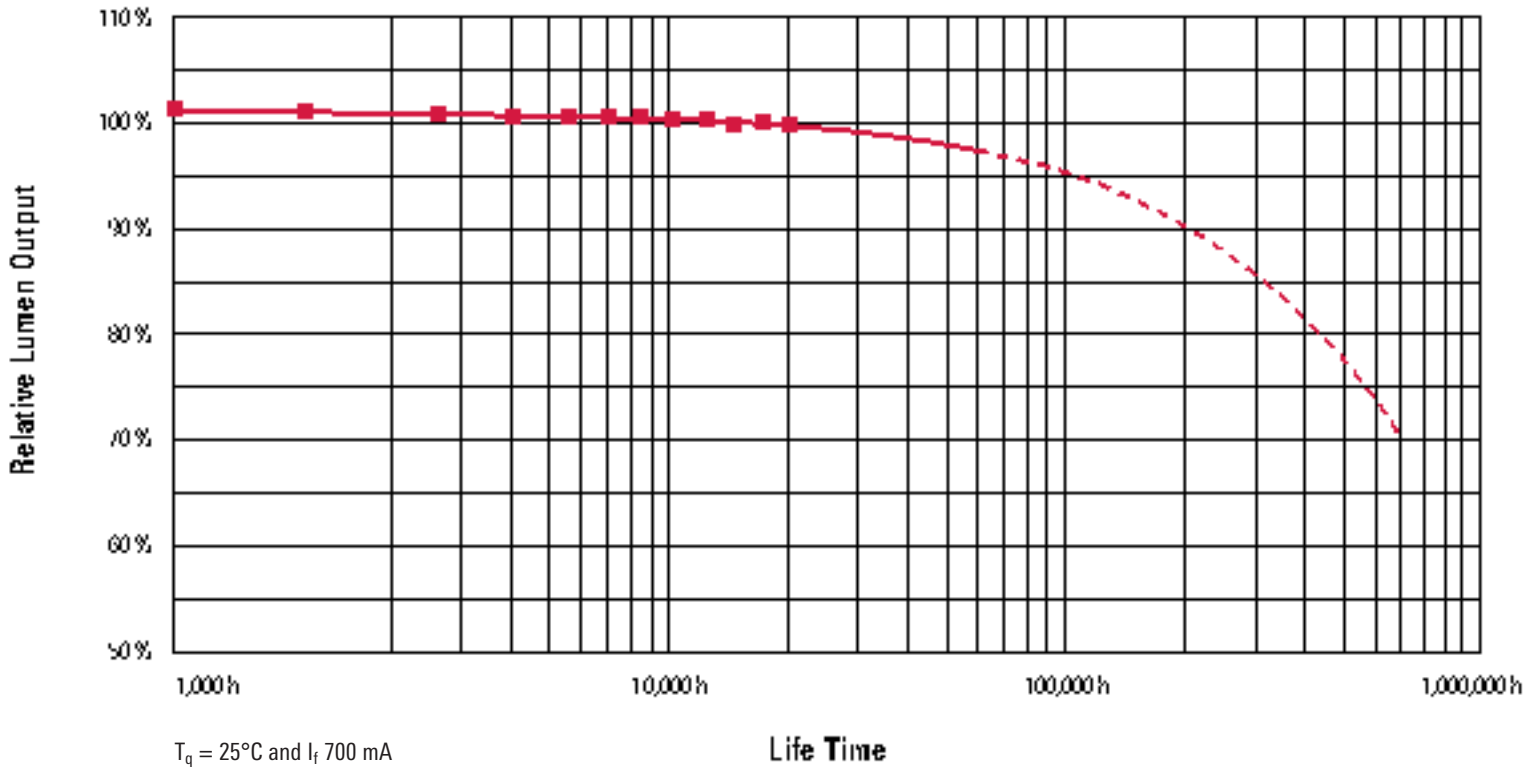

LED ENGINEERING

Maintenance factor MF

When using conventional lamps, the luminaire manufacturer is only responsible for supplying information pertaining to the luminaire maintenance factor (LMF). With the introduction of LED this method of approach changed. All three values which provide the maintenance factor (MF), are to be provided by the luminaire manufacturer, as LEDs are now a fixed part of the luminaire.

In addition, in LED luminaires, the three factors in terms of how they are derived has changed, which is detailed as follows.

$$MF = LLMF \times LSF \times LMF$$

MF Maintenance Factor
 LLMF Lamp Lumen Maintenance Factor
 LSF Lamp Survival Factor
 LMF Luminaire Maintenance Factor

Lamp lumen maintenance factor LLMF

It is also possible to calculate the luminous flux that can be expected after a defined rated service life by multiplying the respective rated luminous flux with a lamp lumen maintenance factor that takes into account the ageing of the LEDs; this is easier than trying to read the information from the diagram.

Example Luminaire: VFL540 [S70], 4000 K
 Part ID: 108-0910
 Nominal luminous flux: 8,854 lm
 Rated luminous flux: 8,164 lm

Using the information in the table, we obtain a lamp lumen maintenance factor of $LLMF = 0.925$ for an average rated ambient performance temperature of 25°C , an operating current of 700 mA and a rated service life of 60,000 h. We obtain the following theoretical minimum rated luminous flux after 60,000 h. $8,164 \times 0.925 = 7,552$ lm.

$T_q = 25^{\circ}\text{C}$				
I_f [mA]	T_J^{***} [$^{\circ}\text{C}$]	TM-21 [1,000 h]	LLMF at 60,000 h	Theoretically Expected Lifetime [1,000 h]
				L95
350*	45	>60	0.975	170
500*	55	>60	0.950	150
700*	69	>60	0.925	120
1,050**	80	>60	0.950	90
1,400**	90	>60	0.925	80

* based on 30,000 h continual testing with XP-G2 LED and than extrapolated
 ** based on 6,000 h continual testing with XP-L LED and than extrapolated
 *** measured, average junction temperature T_J in nominated luminaire series

Lamp survival factor LSF

According to the information provided by the LED manufacturer, due to SIC technology, the total failure rate of LEDs is very small. It is approximately 750ppm (after 60,000 h, if = 700mA/1,050mA/1,400mA).

LSF = 1

Luminaire maintenance factor LMF

LED Luminaires operate differently to HID street & area lighting luminaires. Therefore, the factors applied in line with CIE 154:2003 for WE-EF street & area lighting luminaires have been adjusted.

The reasons for, are as follows:

- a) reduced insect build-up because of less thermal heat across the outer cover and less UW damage due to lamp source
- b) reduced obscuring/ageing of the outer lens due to reduced convection.

Recommended maintenance factor MF after 60.000 h

I _f [mA]	T _J ^{***} [°C]	LLMF	LSF	LMF (4 Years, IP6x)			MF (N)	MF (M)
				N	M	H		
350*	45	0.975	1	0.96	0.92		0.94	0.90
500*	55	0.950	1	0.96	0.92		0.92	0.88
700*	69	0.925	1	0.96	0.92		0.89	0.85
1,050**	80	0.950	1	0.96	0.92		0.92	0.88
1,400**	90	0.925	1	0.96	0.92		0.89	0.85
* based on XP-G2 LED ** based on XP-L LED *** measured, average junction temperature T _J in nominated luminaire series				N = area with low pollution M = area with moderate pollution H = area with high pollution				

LED ENGINEERING

Rated ambient performance temperature T_a

The Isolux curves shown in this catalogue refer to an average rated ambient performance temperature of 25°C. However, conditions at a particular location will often deviate from this standard and can have a fairly significant influence on the technical lighting quality and service life of a system. If the average rated ambient performance temperature falls below 25°C, then the luminous flux and service life increase, and vice versa if the temperature increases above this level.

To obtain a more precise calculation, we recommend that the average rated ambient performance temperature that applies when the luminaire is in operation (i.e. night-time hours) during the hottest month of the year at its respective location is used as a measurement basis. The national weather services publish this type of data. The diagram and table show the average ambient temperature for several selected European countries. You can use e.g. www.laenderdaten.info to obtain more comprehensive and detailed global data for selected cities and regions in Germany and Europe.

	Germany	Belgium	Finland	France	Ireland	Italy	Croatia	Netherlands	Norway	Austria	Portugal	Russian Federation	Sweden	Switzerland	Slovakia	Spain	Czech Republic	Ukraine	Hungary	U. K.
max. °C in July	12.2	12.7	10.8	15.0	11.7	20.7	19.2	12.4	8.5	10.8	17.7	10.3	11.0	13.5	9.7	18.3	12.3	15.5	14.6	11.9
min. °C in January	-2.8	0.1	-14.4	2.1	3.1	6.2	1.3	-0.6	-6.0	-7.4	9.2	-23.2	-10.8	-0.8	-9.4	8.0	-5.4	-7.7	-5.0	2.8
average temperature °C	4.6	6.1	-1.8	8.6	6.9	13.1	10.3	5.5	0.9	2.1	13.2	-6.5	0.4	5.9	1.0	12.7	4.2	4.3	5.0	7.0

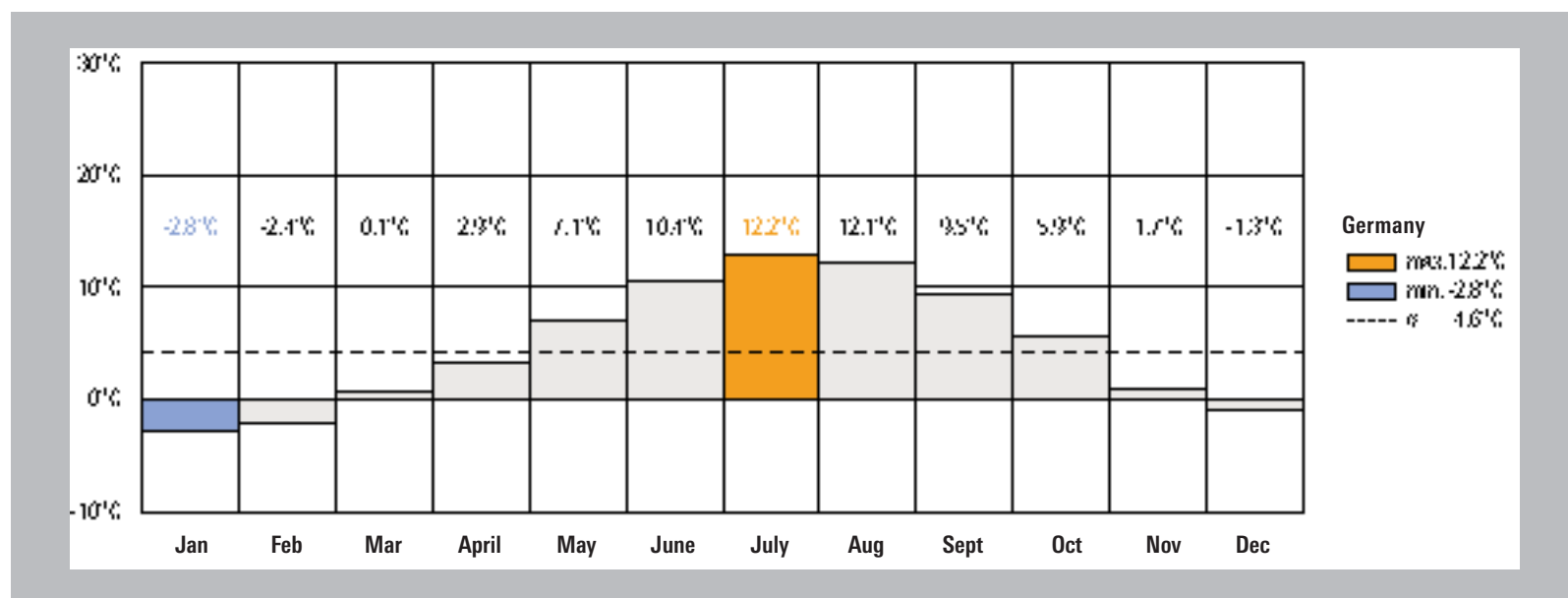

Luminous flux – nominal vs. rated luminous flux

The luminous flux values listed in this catalogue refer to so-called nominal luminous flux levels. They have been obtained from the data sheets of the LED manufacturers and relate to the set operating currents 350 mA, 500 mA, 700 mA, 1,050 mA or 1,400 mA at a junction temperature of 85°C. These values are derived from the laboratories of the LED manufacturers, from free-burning LEDs, with so-called pulsed currents. However, the junction temperature increases differently once the LEDs are in operation inside a luminaire. This temperature is set at a maximum 95°C (based on an average rated ambient performance temperature $T_q = 25^\circ\text{C}$) for the WE-EF luminaires shown in this catalogue. This heating up of the LED leads to a change in luminous flux, hence a decrease in the luminous flux which must be recorded when the luminaire is measured in the lighting laboratory. All of the technical lighting data published by WE-EF takes this context into account. It means that technical lighting computer calculations using original WE-EF technical lighting data, such as is available worldwide via DIALUX, also render these correlations correctly. Current information regarding the luminous flux that can be achieved during the operation of the luminaire can be obtained from www.we-ef.com.

PRODUCT INFORMATION

5CE Superior Corrosion Protection



Outstanding and long lasting anticorrosion properties can only be achieved by a comprehensive, integrated approach. The result of many years of research and development, hands-on testing and experience, WE-EF's unique 5CE system encompasses 5 Critical Elements:

1. Substrate
2. Conversion Coating
3. Powder
4. PCS Hardware
5. Process control



Powder Applications



PCS Hardware

1. Substrate

A marine grade, low copper content aluminium alloy is used for all above ground luminaires. Typical alloy composition:

Cu	≤	0.1 %	Zn	≤	0.1 %
Mg	≤	0.1 %	Ph	≤	0.1 %
Si	=	10.0-13.5 %	Sn	≤	0.05 %
Fe	≤	1.0	Ti	≤	0.2 %
Mn	≤	0.5 %	Al	=	Balance
Ni	≤	0.1 %			

2. Conversion Coating

The multi-step pre-treatment and conversion coating process includes degreasing, deoxidizing, etching and depending on product, zirconium conversion coating. It is considered the most effective conversion coat available for aluminium substrates.

Zirconium conversion coating process:

- Acid degreasing / etching
- Clear water rinse
- Counterflow clear water rinse
- Demineralised water rinse
- Zirconium (+polymer) conversion coating (3-10 mg/m²)
- Hot air drying

Strict controls are constantly maintained over the parameters of every step in each process, such as purity, pH, chemical concentrations, temperature, etc. This ensures the best achievable substrate penetration and uniformity of the conversion coat, thereby ensuring optimum corrosion resistance and powdercoat adhesion.

3. Powder

UV-stabilised, architectural grade polyester powder is electrostatically applied (60-100 µm) and oven cured at ~ 200°C. The grade of polyester powder used is based on saturated polyester resins. Combined with UV resistant cross-linking agents and selected pigments, it features outstanding resistance to atmospheric ageing and UV light exposure. Properly applied to a suitable metal substrate, the resulting powdercoat finish exhibits excellent outdoor durability, and complies with German GSB and European QUALICOAT standards.

4. PCS Hardware



All exposed hardware is made from austenitic stainless steel, and additionally sealed with a tough, impregnated polymer coat, which fulfills two functions:

- Reduced friction between male and female thread causes tighter fit between connected parts.
- Non-metallic barrier between the two metals, aluminium and steel, prevents galvanic corrosion that otherwise occurs, when metals of dissimilar electro-negativities are in contact.

5. Process Control

All materials and production steps are part of a tightly controlled process under ISO9001 quality assurance. It includes ongoing spectrometer analysis of aluminium alloy used, daily checks of chemicals concentration in the pre-treatment phase, quality control checks on finished parts, up to 2,000 hours salt spray exposure tests etc.

The Final Product

The final result is a quality product of excellent corrosion resistance, that can be serviced after years of operation, and features a powdercoat finish of outstanding adhesion and colour stability.

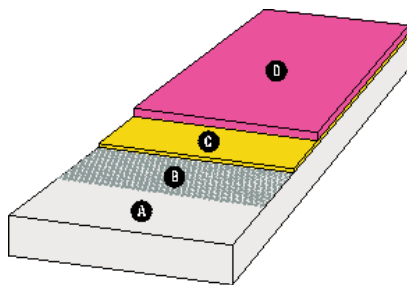

- A Marine Grade Aluminium Alloy
- B Etched Surface
- C Conversion Coating
- D Architectural Grade Powder Coat

5CE + Primer



For installations where corrosion protection over and above the 5CE system is required, 5CE+ Primer introduces an additional element to the process:

1. Substrate
2. Conversion Coating + Primer
3. Powder Top Coat
4. PCS Hardware
5. Process control

Primer

Immediately after conversion coating, a specially formulated 'intercoat' bonding epoxy primer is electrostatically applied (80-100 µm), and initially semi-cured in a 180°C oven. Following the subsequent application of the polyester powder top coat, full curing and essential 'intercoat' bond is achieved at 200°C.

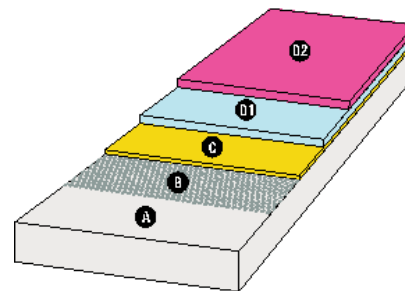

- A Metal substrate
- B Etched Surface
- C Conversion Coating
- D.1 'Intercoat' bonding primer
- D.2 Architectural Grade Powder Coat

Luminaires

WE-EF luminaires may be custom ordered to feature the described 5CE+ Primer finish.

PRODUCT INFORMATION

ASC Anti Slip Coating for Inground Uplights

A translucent, tough and highly abrasion resistant ceramic material is fused into the surface of the luminaire's safety glass lens. Slip resistance, as required in pedestrian traffic and wet environments, conforms with DIN 51130 (class R10) and AS/NZS4586:1999 (class V). Corresponding tests were performed at the German BIA and the Australian CSIRO institutes. Arranged in a stochastic (irregular) pattern, the ASC Anti Slip Coating has only moderate effect on the luminaire's light distribution and LOR (light output ratio).

CTA® Cool Touch Adaptor for Inground Uplights



Designed for inground uplights, this unique accessory provides significant reduction in glass surface temperature, while maintaining high LOR (light output ratio). The matt black die-cast aluminium adaptor features a prismatic glass insert, and is hinged to permit easy relamp. The effect on operating temperature of electrical components is negligible (WE-EF Patent DE 10013304).

Lenses and Diffusers

Toughened safety glass, borosilicate glass, acrylic (PMMA) and UV-stabilised polycarbonate (PC) are used throughout the WE-EF product range. Usage is depending on product and application. Safety glass lenses used in inground luminaires are load rated up to 5 tonnes.

Gasketing

Weatherproof and non-ageing silicone rubber is used extensively in the WE-EF range. It provides excellent sealing qualities in corrosive and high temperature environments. A number of luminaires are also designed with CCG (Controlled Compression Gasket) technology for a maintained protection rating.

Electronic Control Gear

WE-EF luminaires equipped with ECG control gear provide energy savings, extended lamp life and stable colour temperature. The circuit's power factor is up to 0.97.

Electromagnetic Control Gear

WE-EF luminaires equipped with magnetic ballasts and power factor correcting capacitors feature an HPF high power factor of up to 0.95. LPF low power factor versions are available on request.

Voltage

WE-EF luminaires and electrical accessories are supplied ready for connection to a 230 V 50 Hz supply. Control gear for other voltages and frequencies is available on request.

Electrical Protection

German and European industrial standards DIN/EN 60598, VDE 0711 and DIN 40050, specify electrical protection and IP classification of luminaires. WE-EF products comply with these as well as with equivalent international standards. WE-EF luminaires conform to electrical protection class I. The compulsory earthing terminal is marked with the symbol ⊕. In the event of a fault, a correctly installed luminaire shall cause the circuit protection device to trip. Special luminaire versions with protection according to Class II ⊞ are available on request.

Ambient Temperatures

The WE-EF range of products is generally designed for operation at 25°C. In many cases, test data confirm higher ratings, at 40°C or more. For installations where excessive ambient temperatures exist, special luminaires and equipment can be supplied on request.

Standards

WE-EF luminaires, floodlights and lighting columns are designed to conform with present DIN/EN and VDE standards. Furthermore, all luminaires manufactured for the European market bear the CE standards conformity mark. WE-EF is constantly developing and improving its products. The technical information given, including data and designs, can be subject to change without prior notice. The dimensions and weights stated are approximate values, subject to manufacturing tolerances. Special finishing, executions and constructions are available on request.

LED Light Emitting Diodes

Only first grade (bin-1) High Efficiency LEDs by leading international manufacturers are used. LED performance in terms of light output and life is substantially influenced by effective thermal management and suitably matched control devices. These are critical issues particularly when applied to sealed, IP rated exterior luminaires.

Lamps

Luminaires exclude lamps, which are ordered separately. Refer to Lamp Chart on pages 424-426 for lamp manufacturers' cross references.

Installation

Installation instructions are provided with all WE-EF products. Suitably qualified personnel must be engaged for installation and maintenance in compliance with the latest applicable regulations and relevant legislation.

Customer Service

Supported by WE-EF expertise, authorised agents provide planning services to consulting engineers, lighting designers and other professionals. The current status of our global distribution network as well as substantial technical and product information, such as product specifications, photometric data and software can be obtained by visiting our website at www.we-ef.com.

IP-Classification

The international Protection Code (IP) classifies luminaires according to their protection against the ingress of dust, solid foreign bodies and water.

- IP1X Protection against solid objects of diameter greater than 50 mm
- IP2X Protection against finger touch and solid objects of diameter greater than 12 mm
- IP3X Protection against solid objects of diameter greater than 2.5 mm
- IP4X Protection against solid objects of diameter greater than 1.0 mm
- IP5X Complete protection against solid objects and harmful dust deposits (dust proof)
- IP6X Total protection against dust (dust-tight)
- IPX1 Protection against vertically dripping water (drip proof)
- IPX2 Protection against dripping water up to 15° from the vertical
- IPX3 Protection against spraying water or falling rain up to 60° from the vertical (rain proof)
- IPX4 Protection against splashing water from any direction (splash proof)
- IPX5 Protection against water jets from any direction (jet proof)
- IPX6* Protection against heavy seas or powerful water jets
- IPX7* Protection against the effects of immersion (watertight-immersible)
- IPX8* Protection against submersion (pressure watertight-submersible)

The combination of both numerals describes the IP classification of a luminaire. All WE-EF luminaires are marked accordingly, e.g. IP66 (dust and water jet tight).

* WE-EF luminaires that comply with IPX7 and/or IPX8 are always additionally tested to meet IPX6 requirements under DIN EN 60529. This is because the test conditions and procedures for IPX7 and IPX8 differ significantly from those for IPX6 and compliance for all is not automatically assured.

LIGHTING DATA AND PROJECT SUPPORT

Light Distribution (Fig. 1 and 2)

The three dimensional light distribution pattern of a luminaire is measured by means of a so-called photo goniometer. Depending on their application, WE-EF luminaires feature light distributions that are either symmetrical, bi-symmetrical or asymmetrical. Luminous intensities are measured in cd/klm, and form the basis for lighting design calculations. This catalogue features a range of different photometric diagrams, in order to enable the lighting practitioner to conduct rough calculations. Detailed and precise calculations can be made by using lighting design software.

Isolux Diagrams (Fig. 3)

Illuminance, as a measure, indicates how strongly a surface is lit. The distribution of illuminance on a surface is presented by the isolux diagram. All points of identical illuminance levels are connected by a line. Variations in mounting height or aiming of a luminaire will result in an altered diagram.

Luminance Diagrams (Fig. 4)

Luminaires with opal or frosted lenses are generally used for orientation. For functional and aesthetic evaluation, the level of the average luminance on the lens, as well as its uniformity, have to be taken into consideration.

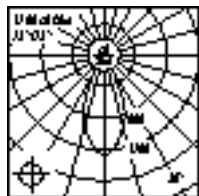

Fig. 1

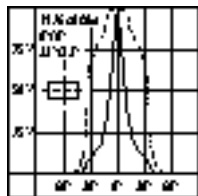

Fig. 2

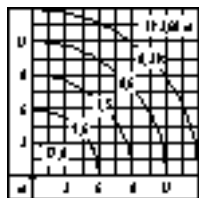

Fig. 3

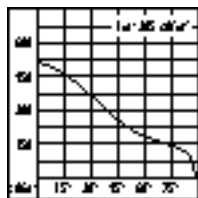

Fig. 4

Luminance diagrams shown in this catalogue present the lens' luminance as a function of the observer's viewing angle. They are based on a maintenance factor of 1.0 for new installations. The unit of measure is candelas per square metre (cd/sqm).

Project Support

WE-EF's customer service includes lighting design and planning support for project engineers, lighting consultants and other professionals. While varying specific customer requirements and installation practices are taken into consideration, the following German/European standards are generally used as a working basis:

DIN EN 12464 Workplace lighting

DIN EN 12193 Sport lighting

DIN EN 13201 Street lighting



LIGHTING DATA AND PROJECT SUPPORT

Streetlighting standards – EN 13201

Among other things, the EN 13201 streetlighting standard requires that safety standards and standards related to comfortable lighting conditions be met. Currently, economic operation in conjunction with environmentally-friendly and sustainable luminaire design are essential. Depending on the application, visual systems are employed that optimise luminance and illuminance. WE-EF guarantees modern optical state-of-the-art systems. Highly-specialised employees, suitable simulation software, a technical lighting laboratory and corresponding tool construction constitute the foundation on which WE-EF realises its goal of becoming a world leader in the field of reflector and lens system development.

Illuminance (Lux/lx)

The illuminance measures the amount of light thrown by a streetlighting luminaire onto a surface, e.g., a road (the reference surface). The reflection properties of the illuminated surface are not taken into account. This means that, with the same technical features (luminaire type, number of luminaires, mounting height, road geometry etc.), the results are identical even if road surfaces differ (dark R3 asphalt or light R2 cement) and how the human eye perceives them varies. The criterion of illuminance is therefore only used for smaller roads with low to medium volumes of traffic. Classes S1 to S6 are used depending on requirements. Typical assessment criteria are the mean illuminance (E_m) and total uniformity (U_o).

Luminance (candela per square metre/cd/m²)

The calculation of luminance takes into account the reflective properties of a road surface. This means that, with the same technical features (luminaire type, number of luminaires, mounting height, road geometry etc.), the results vary with different road surfaces (dark R3 asphalt or light R2 cement). Road conditions (e.g., dry or wet) also affect the results as does the point of view selected for the calculation. Classes ME1 to ME6 are used here depending on requirements. Typical assessment criteria are the mean luminance (L_m), total uniformity (U_o), longitudinal uniformity (UI), threshold increment (TI) and the ambient illuminance ratio (SR).

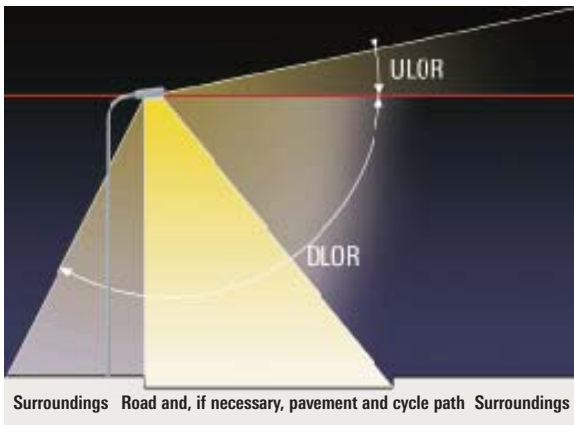

ULOR: The main task of optical systems is to effectively direct light onto target surfaces that are to be illuminated. With regard to streetlighting, this means light emitted above the horizontal is not only useless, but will also unnecessarily light up the night sky. The upwards flux light output ratio (ULOR) is a measure of how much light escapes from the luminaire into the sky. A ULOR of zero per cent therefore indicates that no light whatsoever escapes from the luminaire into the night sky. The better the optical systems, the lower the burden on the environment.

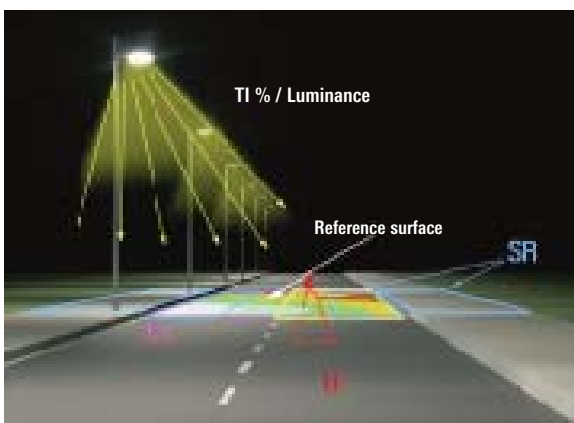

Reference surface = surface for which the calculation is carried out

U_0 = total uniformity of luminance or illuminance on the reference surface.

U_l = Uniformity of luminance on the reference surface in the direction of travel.

TI = Threshold increment.

SR = Ambient illuminance ratio.

Lighting Class ME					
	L_m cd/m ²	U_0	U_l	TI %	SR
ME1	2	0.4	0.7	10	0.5
ME2	1.5	0.4	0.7	10	0.5
ME3a	1	0.4	0.7	15	0.5
ME3b			0.6		
ME3c			0.5		
ME4a	0.75	0.4	0.6	15	0.5
ME4b			0.5		
ME5	0.5	0.35	0.4	15	0.5
ME6	0.3	0.35	0.4	15	–

Lighting Class S		
Class	E_m lx	E_{min} lx
S1	15	5
S2	10	3
S3	7.5	1.5
S4	5	1
S5	3	0.6
S6	2	0.6

In accordance with EN 13201-2 Streetlighting – Part 2: Performance requirements.

LIGHTING DATA AND PROJECT SUPPORT

Recommended Values (excerpt) as per DIN EN 12464-2:2014

General requirements for areas and for cleaning at outdoor work places	Em (lux)	U0	RG _L	Ra ≥	Ref. No. EN 12464-2:2014 (E)
Walkways exclusively for pedestrians	5	0.25	50	20	5.1.1
Traffic areas for slowly moving vehicles (max. 10 km/h), e.g. bicycles, trucks and excavators	10	0.40	50	20	5.1.2
Regular vehicle (max. 40 km/h) traffic	20	0.40	45	20	5.1.3
Pedestrian passages, vehicle turning, loading and unloading points	50	0.40	50	20	5.1.4
Cleaning and servicing	50	0.25	50	20	5.1.5

Canals, locks and harbours	Em (lux)	U0	RG _L	Ra ≥	Ref. No. EN 12464-2:2014 (E)
Waiting quays at canals and locks	10	0.25	50	20	5.4.1
Gangways and passages exclusively pedestrians	10	0.25	50	20	5.4.2
Lock control and ballasting areas	20	0.25	55	20	5.4.3
Cargo handling, loading and unloading	30	0.25	55	20	5.4.4
Passenger areas in passenger harbours	50	0.40	50	20	5.4.5
Coupling of hoses, pipes and ropes	50	0.40	50	20	5.4.6
Dangerous part of walkways and driveways	50	0.40	45	20	5.4.7

Building Sites	Em (lux)	U0	RG _L	Ra ≥	Ref. No. EN 12464-2:2014 (E)
Clearance, excavation and loading	20	0.25	55	20	5.3.1
Construction areas, drain pipes mounting, transport, auxiliary and storage tasks	50	0.40	50	20	5.3.2
Framework element mounting, light reinforcement work, wooden mould and framework mounting, electric piping and cabling	100	0.40	45	40	5.3.3
Element jointing, demanding electrical, machine and pipe mountings	200	0.50	45	40	5.3.4

Parking Areas	Em (lux)	U0	RG _L	Ra ≥	Ref. No. EN 12464-2:2014 (E)
Light traffic, e.g. parking areas of shops, terraced and apartment houses; cycle parks	5	0.25	55	20	5.9.1
Medium traffic, e.g. parking areas of department stores, office buildings, plants, sports and multipurpose building complexes	10	0.25	50	20	5.9.2
Heavy Traffic, e.g. parking areas of schools, churches, major sport and multipurpose building complexes	20	0.25	50	20	5.9.3

Em = Rated illuminance (lux)

U0 = Uniformity of illuminance Emin/Em

RG_L = upper limit of glare by CIE Glare Rating system

Ra = Colour rendering index

Recommended Values (excerpt) as per DIN EN 13201

ME-series of lighting classes	Luminance of the road surface of the carriageway for the dry road surface condition				
	Ln	U ₀	U ₁	TI ^a	SR ^b
ME1	2.0	0.4	0.7	10	0.5
ME2	1.5	0.4	0.7	10	0.5
ME3a	1.0	0.4	0.7	15	0.5
ME3b	1.0	0.4	0.6	15	0.5
ME3c	1.0	0.4	0.5	15	0.5
ME4a	0.75	0.4	0.6	15	0.5
ME4b	0.75	0.4	0.5	15	0.5
ME5	0.5	0.35	0.4	15	0.5
ME6	0.3	0.35	0.4	15	no requirement

^a An increase of 5 percentage points in TI can be permitted where low luminance light sources are used. (see note 6)

^b This criterion can be applied only where there are no traffic areas with their own requirements adjacent to the carriageway.

Note 6

The Threshold increment (TI) indicates that although road lighting improves visual conditions it also causes disability glare to a degree depending on the type of luminaires, lamps and geometric situation. Low-pressure sodium lamps and fluorescent tubes are normally considered to be low luminance lamps. For these lamps, and luminaires providing less or equivalent luminance, footnote a of Table 1a and footnote b of Table 1b permits higher values.

S-series of lighting classes	Horizontal Illuminance	
	\bar{E} in lx ^a	E _{min} in lx
S 1	15	5
S 2	10	3
S 3	7.5	1.5
S 4	5	1
S 5	3	0.6
S 6	2	0.6
S 7	performance not determined	performance not determined

^a To provide uniformity, the actual value of the maintained average illuminance may not exceed 1.5 times the minimum \bar{E} value indicated for the class.

Ln = Average luminance (cd/m²)

U_l = Longitudinal uniformity L_{min}/L_{max}

TI = Threshold Increment in %

SR = Surrounding Ratio

Recommended Values (excerpt) as per DIN EN 12193 (Illumination of Sports Grounds)

Outdoor	Class I			Class II			Class III		
	Em (lux)	E _{min} /Em	Ra ≥	Em (lux)	E _{min} /Em	Ra ≥	Em (lux)	E _{min} /Em	Ra ≥
Riding - jumping & dressage, light athletics	500	0.7	60	200	0.5	60	100	0.5	20
Basketball, soccer, handball, rugby, volleyball	500	0.7	60	200	0.6	60	75	0.5	20
Golf (Driving Range)*	-	-	-	-	-	-	100	0.8	20
Hockey	500	0.7	60	200	0.7	60	200	0.7	20
Competition swimming, water polo	500	0.7	60	300	0.7	60	200	0.5	20
Tennis	500	0.7	60	300	0.7	60	200	0.6	20
Horse racing* - trotting track, race track and derby	200	0.6	60	100	0.4	60	50	0.2	20







Indoor	Class I			Class II			Class III		
	Em (lux)	E _{min} /Em	Ra ≥	Em (lux)	E _{min} /Em	Ra ≥	Em (lux)	E _{min} /Em	Ra ≥
Badminton, ice-hockey, fencing*, hockey, squash, table-tennis	750	0.7	60	500	0.7	60	300	0.7	20
Basketball, handball, fist-ball, volleyball, judo	750	0.7	60	500	0.7	60	200	0.5	20
Riding - jumping & dressage, light athletics	500	0.7	60	300	0.6	60	200	0.5	20
Competition swimming, water polo	500	0.7	60	300	0.7	60	200	0.5	20
Tennis	750	0.7	60	500	0.7	60	300	0.5	20







* There are additional requirements for vertical illuminance

LAMP CHART

This catalogue lists lamp designations in accordance with the lamp designation system of the German electrotechnical industry. The lamp chart is for comparison purposes only and for luminaires listed in this catalogue. It is not complete and errors are expected.









Due to ongoing research and development by the manufacturers, lamp specifications may change. Ensure that all technical data is checked prior to application.

				OSRAM	PHILIPS	GE
QT (Tungsten Halogen Lamps)						
	QT 12 (-LP) ax 35W/c GY6.35 12V	Ra100	3000 K	64432 ES	---	---
	QT 12 (-LP) ax 65W/c GY6.35 12V	Ra100	3000 K	64447 ES	---	---
	QT18 25W/m B15d	Ra100	2900 K	64466AM	---	---
	QT18 40W/m B15d	Ra100	2900 K	64467AM	---	---
	QT18 60W/m B15d (l=67mm)	Ra100	2900 K	64481AM	---	---
	QT18 75W/m B15d (l=86mm)	Ra100	2900 K	64473AM	12123	---
	QT18 100W/m B15d (l=86mm)	Ra100	2900 K	64475AM	12122	---
	QT-DE 12 150W R7s-15	Ra100	2900 K	64696	---	---
	QT-DE 12 200W R7s-15	Ra100	2900 K	64698	200 T3Q/CL/P small	K11/Q200T3/CL
	QT-DE 12 300W R7s-15	Ra100	2900 K	64701	300 T3Q/CL/P small	K9/Q300T3/CL
TC (Compact Fluorescent Lamps)						
	T5 21W/ ... G5	Ra 80	27/30/4000 K	HE 21W/ ...	TL5 HE 21W/ ...	T5 HE 21W/ ...
	T5 39W/ ... G5	Ra 80	27/30/4000 K	HE 39W/ ...	TL5 HE 39W/ ...	T5 HE 39W/ ...
	T26 58W/827 G13	Ra > 80	2700 K	L 58W/827	---	---
	T26 58W/830 G13	Ra > 80	3000 K	L 58W/830	TL-D 58W/830 SLV	---
	T26 58W/835 G13	Ra > 80	3500 K	L 58W/835	---	---
	T26 58W/840 G13	Ra > 80	4000 K	L 58W/840	TL-D 58W/840 SLV	---
	T26 58W/865 G13	Ra > 80	6500 K	L 58W/865	TL-D 58W/865 SLV	---
	T26 58W/880 G13	Ra > 80	8000 K	L 58W/880	---	---
	TC-TEL 13W/... GX24-q1	Ra 85	27/30/4000 K	DULUX T/E 13W/...PLUS	---	F13TBX/.../4P
	TC-TEL 18W/... GX24-q2	Ra 85	27/30/4000 K	DULUX T/E 18W/...PLUS	---	F18TBX/.../4P
TC-TEL 26W/... GX24-q3	Ra 85	27/30/4000 K	DULUX T/E 26W/...PLUS	---	F26TBX/.../4P	
TC-TEL 32W/... GX24-q3	Ra 85	27/30/4000 K	DULUX T/E 32W/...PLUS	---	F32TBX/.../4P	
TC-TEL 42W/... GX24-q4	Ra 85	27/30/4000 K	DULUX T/E 42W/...PLUS	---	F42TBX/.../4P	
TC-TELI 26W/... GX24-q3	Ra 85	30/4000 K	DULUX T/E 26W/...IN PLUS	---	---	
TC-TELI 32W/... GX24-q3	Ra 85	27/30/4000 K	DULUX T/E 32W/...IN PLUS	---	---	
TC-TELI 42W/... GX24-q4	Ra 85	27/30/4000 K	DULUX T/E 42W/...IN PLUS	---	---	
TC-TELI 57W/... GX24-q5	Ra 85	30/4000 K	DULUX T/E 57W/...IN PLUS	---	---	
TC-L 18W/... 2G11	Ra 85	27/30/4000 K	DULUX L 18W/...	PL-L 18W/4p	F18BX/...	
TC-L 24W/... 2G11	Ra 85	27/30/4000 K	DULUX L 24W/...	PL-L 24W/4p	F24BX/...	
MH (Metal Halide Lamps)						
	HIT-COS 45W/628 PGZ12	Ra > 60	2800 K	---	CPO-TW 45W/628 PGZ12	---
	HIT-COS 60W/628 PGZ12	Ra > 65	2800 K	---	CPO-TW 60W/728 PGZ12	---
	HIT-COS 90W/628 PGZ12	Ra > 65	2800 K	---	CPO-TW 90W/728 PGZ12	---
	HIT-COS 140W/628 PGZ12	Ra > 65	2800 K	---	CPO-TW 140W/728 PGZ12	---
	HIT-TC-CE 20W/830 PGJ5	Ra > 85	3000 K	---	CDM-Tm 20W/830 PGJ5	---
	HIT-TC-CE 35W/930 PGJ5	Ra > 85	3000 K	---	CDM-Tm 35W/930 PGJ5	---

	OSRAM			PHILIPS		GE
	HIT-TC-CE 20W/830 GU6.5	Ra > 80	3000 K	HCI-TF 20W/830 WDL PB	CDM-Tm Mini GU6.5 20W/830	CMH20/T/UVC/830/GU6.5
	HIT-TC-CE 35W/930 GU6.5	Ra > 90	3000 K	HCI-TF 35W/930 WDL PB	CDM-Tm Elite Mini GU6.5 35W/930	CMH35/T/UVC/930/GU6.5
	HIT-TC-CE 35W/942 GU6.5	Ra > 90	4200 K	---	---	CMH35/T/UVC/942/GU6.5
	HIT-TC-CE 50W/930 GU6.5	Ra > 90	3000 K	---	CDM-Tm Elite Mini GU6.5 50W/930	---
	HIT-TC-CE 20W/830 G8.5	Ra > 80	3000 K	HCI-TC 20W/830 WDL PB	---	CMH20/TC/UVC/U/830/G8.5
	HIT-TC-CE 35W/830 G8.5	Ra > 80	3000 K	HCI-TC 35W/830 WDL PB	CDM-TC 35W/830	CMH35/TC/UVC/U/830/G8.5
	HIT-TC-CE 35W/930 G8.5	Ra > 90	3000 K	HCI-TC 35W/930 WDL PB SHOP	CDM Elite - TC 35W/930	---
	HIT-TC-CE 35W/942 G8.5	Ra > 90	4200 K	HCI-TC 35W/942 NDL PB	---	---
	HIT-TC-CE 70W/830 G8.5	Ra > 80	3000 K	HCI-TC 70W/830 WDL PB	CDM-TC 70W/830	CMH70/TC/UVC/U/830/G8.5
	HIT-TC-CE 70W/930 G8.5	Ra > 90	3000 K	HCI-TC 70W/930 WDL PB SHOP	CDM Elite - TC 70W/930	---
	HIT-TC-CE 70W/942 G8.5	Ra > 90	4200 K	HCI-TC 70W/942 NDL PB	---	CMH70/TC/UVC/U/942/G8.5
	HIT-CE 20W/830 G12	Ra > 80	3000 K	---	CDM T 20W/830	---
	HIT-CE 35W/830 G12	Ra > 80	3000 K	HCI-T 35W/830 WDL PB	CDM T 35W/830	CMH35/T/UVC/U/830/G12
	HIT-CE 35W/930 G12	Ra > 90	3000 K	HCI-T 35W/930 WDL PB SHOP	CDM Elite-T 35W/930	---
	HIT-CE 35W/942 G12	Ra > 90	4200 K	HCI-T 35W/942 NDL PB	CDM T 35W/942	CMH35/T/UVC/U/942/G12
	HIT-CE 70W/830 G12	Ra > 80	3000 K	HCI-T 70W/830 WDL PB	CDM T 70W/830	CMH70/T/UVC/U/830/G12
	HIT-CE 70W/930 G12	Ra > 90	3000 K	HCI-T 70W/930 WDL PB SHOP	CDM Elite-T 70W/930	---
	HIT-CE 70W/942 G12	Ra > 90	4200 K	HCI-T 70W/942 NDL PB	CDM T 70W/942	CMH70/T/UVC/U/942/G12
	HIT-CE 100W/830 G12	Ra > 85	3000 K	HCI-T 100W/830 WDL PB	---	---
	HIT-CE 100W/942 G12	Ra > 90	4200 K	HCI-T 100W/942 NDL PB	---	---
	HIT-CE 150W/830 G12	Ra > 85	3000 K	HCI-T 150W/830 WDL PB	CDM T 150W/830	CMH150/T/UVC/U/830/G12
	HIT-CE 150W/942 G12	Ra > 90	4200 K	HCI-T 150W/942 NDL PB	CDM T 150W/942	CMH150/T/UVC/U/942/G12
	HIT-CE 250W/830 G12	Ra > 85	3000 K	---	CDM T 250W/830	---
	HIT-CE/S 250W/830 G22	Ra > 80	3000 K	HCI-TM 250W/830 WDL PB	---	---
	HIT-CE/S 250W/942 G22	Ra > 90	4200 K	HCI-TM 250W/942 NDL PB	---	---
	HIT-CE/S 400W/942 G22	Ra > 90	4200 K	HCI-TM 400W/942 NDL PB	---	---
	HIT 1000W/961 G22	Ra > 90	6100 K	HQI-TM 1000W/961 D	---	---
	HIT-CE 70W/828 E27	Ra > 80	2800 K	---	CDO-TT 70W/828	---
	HIT-CE 70W/830 E27	Ra > 85	3000 K	HCI-TT 70W/830 WDL PB	---	CMH70/TT/U/830/E27
	HIT-CE 100W/830 E40	Ra > 85	3000 K	HCI-TT 100W/830 WDL PB	CDO-TT 100W/828	---
	HIT-CE 150W/828 E40	Ra > 85	2800 K	---	CDO-TT 150W/828	---
	HIT-CE 150W/830 E40	Ra > 85	3000 K	HCI-TT 150W/830 WDL PB	---	CMH150/TT/U/830/E40
	HIT-CE 250W/828 E40	Ra > 85	2800 K	---	CDO-TT 250W/828	---
	HIT-CE 250W/830 E40	Ra > 85	3000 K	HCI-T 250W/830 WDL PB	---	CMH250/TT/U/830/E40
	HIT-CE 250W/942 E40	Ra > 90	4200 K	HCI-T 250W/942NDL PB	---	-
	HIT 250W/952 E40	Ra > 90	5200 K	HQI-T 250W/952 D	---	---
	HIT 400W/635 E40	Ra > 65	3500 K	HQI-T 400W/635 N	---	---
	HIT 400W/952 E40	Ra > 90	5200 K	HQI-BT 400W/952 D	---	---
	HIT 1000W/973 E40	Ra > 90	7250 K	HQI-T 1000W/973 D	---	SPL 1000/T/H/960/E40
	HIE-CE 35W/830 E27	Ra > 85	3000 K	HCI-E/P 35W/830 WDL PB coated*	---	---
	HIE-CE 35W/942 E27	Ra > 90	4200 K	HCI-E/P 35W/942 NDL PB coated*	---	---
	HIE-CE 50W/830 E27	Ra > 85	3000 K	HCI-E/P 50W/830 WDL PB coated*	---	---
	HIE-CE 50W/942 E27	Ra > 90	4200 K	HCI-E/P 50W/942 NDL PB coated*	---	---
	HIE-CE 70W/828 E27	Ra > 75	2800 K	---	CDO-ET 70W/828	CMH70/E/U/830/E27/D
	HIE-CE 70W/830 E27	Ra > 85	3000 K	HCI-E/P 70W/830 WDL PB coated*	---	---
	HIE-CE 70W/942 E27	Ra > 90	4200 K	HCI-E/P 70W/942 NDL PB coated*	---	---

* for open luminaire versions

LAMP CHART

				OSRAM	PHILIPS	GE
	HIE-CE 100W/830 E27	Ra > 85	3000 K	HCI-E/P 100W/830 WDL PB coated*	---	CMH100/E/U/830/E27/D
	HIE-CE 100W/942 E27	Ra > 90	4200 K	HCI-E/P 100W/942 ND L PB coated*	---	---
	HIE-CE 150W/930 E27	Ra > 90	3000 K	HCI-E/P 150W/930 WDL PB coated*	---	---
	HIE-CE 150W/942 E27	Ra > 90	4200 K	HCI-E/P 150W/942 ND L PB coated*	---	---
	HIE-CE 150W/828 E40	Ra > 80	2800 K	---	---	---
	HIE-CE 250W/830 E40	Ra > 85	3000 K	HCI-E 250W/830 WDL PB coated	---	---
	HIE 400W/947 E40	Ra > 90	4700 K	HQI-E/P 400W/947 D coated	---	---
	HIE 400W/952 E40	Ra > 90	5200 K	HQI-E 400W/952 D coated	---	---
	HIT-DE-CE 70W/830 RX7s	Ra > 80	3000 K	HCI-TS 70W/830 WDL PB	CDM-TD 70W/830	CMH70/TD/UVC/830/Rx7s
	HIT-DE-CE 70W/942 RX7s	Ra > 90	4200 K	HCI-TS 70W/942 ND L PB	CDM-TD 70W/942	CMH70/TD/UVC/942/Rx7s
	HIT-DE-CE 150W/830 RX7s	Ra > 85	3000 K	HCI-TS 150W/830 WDL PB	CDM-TD 150W/830	CMH150/TD/UVC/830/Rx7s
	HIT-DE-CE 150W/942 RX7s	Ra > 95	4200 K	HCI-TS 150W/942 ND L PB	CDM-TD 150W/942	CMH150/TD/UVC/942/Rx7s
	HIT-DE 250W/830 Fc2	Ra = 80	3200K	HQI-TS 250/830 WDL	---	---
	HIT-DE 250W/842 Fc2	Ra > 85	4200 K	HQI-TS 250W/842 ND L	MHN-TD 250W/842	RC250/TD/840/Fc2
	HIT-DE 250W/951 Fc2	Ra > 90	5100 K	HQI-TS 250W/951 D	---	---
	HIT-DE 400W/842 Fc2	Ra > 85	4200 K	HQI-TS 400W/842 ND L	---	---
	HIT-DE 400W/952 Fc2	Ra > 90	5200 K	HQI-TS 400W/952 D	---	---
	HIT-SA-DE 1000W/959 Cable	Ra > 90	5900 K	HQI-TS 1000W/959 D S	---	---
	HIT-SA-DE 2000W/959 Cable	Ra > 90	5900 K	HQI-TS 2000W/959 D S	MHN-SB Pro 2000W/956/400V	---
	HIT-LA-DE 1000W/842 Cable	Ra > 80	4200 K	---	MHN-LA 1000W/842 230V	---
	HIT-LA-DE 1000W/956 Cable	Ra > 90	5600 K	---	MHN-LA 1000W/956 230V	---
	HIT-LA-DE 2000W/842 Cable	Ra > 80	4200 K	---	MHN-LA 2000W/842 400V	---
	HIT-LA-DE 2000W/956 Cable	Ra > 90	5600 K	---	MHN-LA 2000W/956 400V	---
	HIT-LA-DE 1000W/642 Cable/FC	Ra > 65	4200 K	---	MHN-FC 1000W/740 230V X-W	---
	HIT-LA-DE 1000W/655 Cable/FC	Ra > 65	5500 K	---	MHN-FC 1000W/750 230V X-W	---
	HIT-LA-DE 2000W/642 Cable/FC	Ra > 65	4200 K	---	MHN-FC 2000W/740 400V X-W	---
HPS (High Pressure Sodium Lamps)						
	HST-X4 50W/220 E27	Ra 25	2000K	NAV-T 50 SUPER 4Y	SON-T PLUS 50W	LU50/90/XO/T/27
	HST-X4 70W/220 E27	Ra 25	2000K	NAV-T 70 SUPER 4Y	SON-T PLUS 70W	LU70/90/XO/T/27
	HST-X4 100W/220 E40	Ra 25	2000K	NAV-T 100 SUPER 4Y	SON-T PLUS 100W	LU100/100/XO/T/40
	HST-X4 150W/220 E40	Ra 20	2000K	NAV-T 150 SUPER 4Y	SON-T PLUS 150W	LU150/150/XO/T/40
	HST-X4 250W/220 E40	Ra 20	2000K	NAV-T 250 SUPER 4Y	SON-T 250W	LU250/XO/T/40
	HST-X4 400W/220 E40	Ra 20	2000K	NAV-T 400 SUPER 4Y	SON-T 400W	LU400/XO/T/40
	HST-X4 600W/220 E40	Ra 25	2000K	NAV-T 600 SUPER 4Y	SON-T PLUS 600	LU600/XO/T/40
	HST 1000W/220 E40	Ra 20	2000K	NAV-T 1000	SON-T 1000W	LU1000/110/T/40 4pk
	HST-DE-X4 70W/220 RX7s	Ra 25	2000K	NAV-TS 70 SUPER 4Y	---	---
	HST-DE-X4 150W/220 RX7s	Ra 25	2000K	NAV-TS 150 SUPER 4Y	---	---
	HST-DE 250W/220 Fc2	Ra 20	2000K	NAV-TS 250	---	LU250/TD
	HST-DE 400W/220 Fc2	Ra 20	2000K	NAV-TS 400	---	LU400/TD

* for open luminaire versions





SERIES INDEX

series	page	series	page	series	page
AL500	246	ETV100 LED	38	PFL500 LED	218
ALP500	248	FLA400	360	PIA200	108
AM-K	388	FLA400 LED	358	PIA200 LED	106
AM-K-K	389	FLA700	344	QLS400	86
AML-K	390	FLA700 LED	342	QRI300	72
AML-K	390	FLB100	328	QRI300 LED	70
AM-R	384	FLB100 - RAIL66	274	QRO300 LED	68
AM-S	386	FLB400	330	RFL500-SE LED	194
AM-S-B	387	FLC100	292	RFL500-SE	198
AM-V	392	FLC100 - RAIL66	270	RFS500 LED	192
AMW-Z	382	FLC100 LED	288	RMC300 LED	184
AM-Z	380	FLC100 LED - RAIL66	268	RMT300 LED	188
AOP500 LED	250	FLC200	304	SLS400 LED	94
ASP500 LED	252	FLC200 BL	318	STF100 LED	60
BSP500 LED	254	FLC200 CC	316	STI100 LED	60
CFT500 LED	190	FLC200 CC + BL	320	STI200 LED	66
CFY200 LED	146	FLC200 LED	302	STL100 LED	58
DAC200	130	FLD100 LED	298	STL200 LED	64
DAC200 LED	128	FLD100 LED - RAIL66	272	STO100 LED	58
DAC200-GB LED	126	FM-K	394	STO200 LED	64
DLG200 LED	110	KTY200 LED	172	SVL100 LED	58
DLO200 LED	110	LCI400	166	SVL200 LED	62
DOC200	124	LGI400	168	SVO200 LED	62
DOC200 LED	120	LSM400	162	TRO200 LED	56
DOC200-GB LED	116	LSP400	158	UDN300	82
DOC200-GB	118	LSP400 LED	156	ULC200	10
Eco Step Dim®	260	LTC400	164	VFL500 LED	206
EFC100 LED	20	LTM400	162	VLR100 LED	78
EFL500 LED	242	LTM440 LED	160	VLS400 LED	90
ESC100 LED	22	LTP400	158	XLO200 LED	112
ETC100	28	LTP400 LED	156	XRX300 LED	140
ETC100 LED	24	NTY100	150	XRY300 LED	140
ETC100-GB LED	32	NTY100 LED	148	ZA600 LED	180
ETC300 LED	36	OLV300	102	ZFT400 LED	174
ETC300 GB LED	34	OLV300 LED	98	ZFY200 LED	144
ETR100	44	PFL200	228		
ETR100 LED	42	PFL200 LED	224		

PRODUCT INDEX

Part ID	page	Part ID	page	Part ID	page	Part ID	page
105		108-0103	232	108-0485	238	108-0829	220
105-0079	191	108-0104	232	108-0491	234	108-0830	220
105-0081	191	108-0105	232	108-0492	234	108-0831	220
105-0083	191	108-0131	230	108-0493	234	108-0832	220
105-0085	191	108-0194	230	108-0494	234	108-0833	220
105-0087	191	108-0196	230	108-0495	234	108-0875	207
105-0093	191	108-0211	109	108-0496	234	108-0877	207
105-0095	191	108-0268	232	108-0497	234	108-0879	207
105-0097	191	108-0280	232	108-0500	234	108-0881	208
105-0099	191	108-0281	232	108-0501	234	108-0883	208
105-0101	185	108-0299	236	108-0532	236	108-0885	208
105-0103	185	108-0342	236	108-0533	236	108-0901	207
105-0105	185	108-0343	236	108-0534	236	108-0904	208
105-7028	189	108-0373	232	108-0540	230	108-0907	207
105-7029	189	108-0380	236	108-0541	231	108-0910	208
105-7034	189	108-0417	109	108-0543	230	108-0913	207
105-7046	189	108-0418	109	108-0647	230	108-0916	208
105-9790	185	108-0419	109	108-0648	231	108-0926	209
105-9791	185	108-0420	109	108-0705	230	108-0929	209
105-9792	185	108-0422	229	108-0713	232	108-0932	209
105-9835	185	108-0423	229	108-0714	232	108-0938	209
105-9836	185	108-0425	229	108-0745	230	108-0941	209
105-9837	185	108-0426	229	108-0746	230	108-0944	209
105-9845	186	108-0427	109 / 240 / 356	108-0749	229	108-0949	219
105-9846	186	108-0428	109 / 240 / 356	108-0752	229	108-0950	219
105-9847	186	108-0430	234	108-0755	109	108-0951	219
105-9848	186	108-0431	234	108-0758	109	108-0952	219
105-9886	189	108-0432	234	108-0781	238	108-0953	219
105-9887	189	108-0433	232	108-0782	238	108-0954	219
105-9926	189	108-0434	232	108-0783	238	108-0955	221
105-9927	189	108-0435	232	108-0784	238	108-0956	221
105-9938	189	108-0450	109	108-0788	238	108-0957	221
107		108-0452	109	108-0789	238	108-0958	221
107-0080	243	108-0458	109	108-0790	238	108-0959	221
107-0082	243	108-0469	109 / 240 / 356	108-0791	238	108-0960	221
107-0085	243	108-0470	109 / 240 / 356	108-0792	238	108-0961	221
107-0087	243	108-0473	236	108-0793	238	108-0962	221
108		108-0474	238	108-0794	238	108-0963	221
108-0016	230	108-0475	238	108-0795	238	108-0964	221
108-0024	231	108-0476	238	108-0796	238	108-0965	221
108-0026	231	108-0477	238	108-0797	238	108-0966	221
108-0040	240 / 356	108-0478	238	108-0822	220	108-0967	208
108-0041	240 / 356	108-0479	238	108-0823	220	108-0968	208
108-0044	232	108-0480	238	108-0824	220	108-0969	208
108-0045	232	108-0481	238	108-0825	220	108-0970	208
108-0048	231	108-0482	238	108-0826	220	108-0971	208
108-0050	231	108-0483	238	108-0827	220	108-0972	208
108-0056	232	108-0484	238	108-0828	220	108-0973	209

PRODUCT INDEX

Part ID	page	Part ID	page	Part ID	page	Part ID	page
108-0974	209	108-1286	213	108-1664	107	108-7171	363
108-0975	209	108-1288	211	108-1666	107	108-7333	359
108-0976	209	108-1290	212	108-1678	225	108-7337	359
108-0977	209	108-1292	213	108-1680	227	108-7339	359
108-0978	209	108-1294	212	108-1682	226	108-7688	363
108-0979	214 / 222 / 244	108-1296	213	108-1688	225	108-7690	363
108-0980	214 / 222 / 244	108-1298	211	108-1690	227	108-7702	359
108-0981	214 / 222 / 244	108-1300	212	108-1692	226	108-7706	359
108-0982	214 / 222 / 244	108-1302	213	108-1700	225	108-7708	359
108-1124	207	108-1304	212	108-1702	227	108-7712	359
108-1127	208	108-1306	213	108-1704	226	108-7716	359
108-1130	209	108-1308	211	108-1724	225	108-7718	359
108-1133	208	108-1310	212	108-1726	227	108-7723	359
108-1136	209	108-1312	213	108-1728	226	108-7727	359
108-1139	207	108-1314	212	108-1730	225	108-7729	359
108-1142	208	108-1316	213	108-1747	107	108-9164	361
108-1145	209	108-1318	211	108-1749	107	108-9168	361
108-1148	208	108-1320	212	108-1751	107	108-9260	368
108-1151	209	108-1322	213	108-1759	107	108-9262	368
108-1154	207	108-1324	212	108-1761	107	108-9264	368
108-1157	208	108-1326	213	108-1763	107	108-9268	368
108-1160	209	108-1481	207	108-1774	225	108-9800	368
108-1163	208	108-1483	207	108-1776	227	108-9802	368
108-1166	209	108-1485	208	108-1778	226	108-9808	368
108-1169	207	108-1487	208	108-1780	225	108-9810	368
108-1172	208	108-1489	208	108-1782	225	111	
108-1175	209	108-1491	208	108-1784	227	111-0003	199
108-1178	208	108-1493	209	108-1786	226	111-0004	199
108-1181	209	108-1495	209	108-1788	225	111-0005	199
108-1248	211	108-1497	209	108-1851	107	111-0006	199
108-1250	212	108-1499	209	108-1852	107	111-0009	199
108-1252	213	108-1501	207	108-1878	211	111-0010	199
108-1254	212	108-1503	207	108-1880	211	111-0011	199
108-1256	213	108-1553	207 / 211	108-1882	211	111-0012	199
108-1258	211	108-1555	207 / 211	108-1884	211	111-0017	199
108-1260	212	108-1557	207 / 211	108-7019	361	111-0018	199
108-1262	213	108-1559	207 / 211	108-7021	361	111-0019	199
108-1264	212	108-1623	227	108-7024	361	111-0023	199
108-1266	213	108-1629	226	108-7048	363	111-0024	199
108-1268	211	108-1630	225	108-7050	363	111-0025	199
108-1270	212	108-1632	225	108-7088	363	111-0040	200 / 216
108-1272	213	108-1639	227	108-7107	361	111-0041	200 / 216
108-1274	212	108-1641	225	108-7110	361	111-0042	200 / 216 / 244
108-1276	213	108-1643	226	108-7118	363	111-0043	200 / 216 / 244
108-1278	211	108-1649	107	108-7121	363	111-0044	200 / 216
108-1280	212	108-1653	107	108-7157	361	111-0045	200 / 216
108-1282	213	108-1655	107	108-7160	361	111-0046	200 / 216
108-1284	212	108-1660	107	108-7168	363	111-0047	200 / 216

PRODUCT INDEX

Part ID	page	Part ID	page	Part ID	page	Part ID	page
111-0052	200 / 216	111-0424	196	112-0011	83	115-1344	175
111-0053	202 / 214	111-0425	196	112-0012	83	115-1346	175
111-0054	202 / 214	111-0426	196	112-0013	83	115-1348	175
111-0055	202 / 214	111-0427	196	112-0014	85	115-1350	177
111-0075	204	111-0428	197	112-0015	85	115-1352	177
111-0076	204	111-0429	197	112-0020	151	115-1354	175
111-0077	204	111-0430	197	112-0021	151	115-1356	175
111-0084	200 / 216 / 244	111-0431	197	112-0022	152	115-1358	191
111-0086	202 / 214	111-0432	197	112-0034	151	115-1360	177
111-0088	202 / 214	111-0433	197	112-0035	151	115-1362	177
111-0089	202 / 214	111-0440	193	112-0045	83 / 85	115-1364	177
111-0126	199	111-0441	193	112-0070	83 / 85	115-1366	177
111-0128	199	111-0442	193	112-0080	83 / 85	115-1368	177
111-0178	202 / 216	111-0443	193	112-0084	83 / 85	115-1370	177
111-0179	202 / 216	111-0444	193	112-0222	83 / 85	115-1372	177
111-0184	204	111-0593	193	112-0226	83 / 85	115-1385	177
111-0337	195	111-0623	193	112-0227	83 / 85	115-9214	141
111-0339	195	111-0629	193	112-0228	83 / 85	115-9612	141
111-0341	195	111-0636	200 / 216	112-0265	85	115-9624	141
111-0343	195	111-0637	200 / 216	112-0299	149	115-9687	141
111-0345	196	111-0639	200 / 216	112-0301	149	116	
111-0347	196	111-0640	200 / 216	112-0303	149	116-0013	159
111-0349	196	111-0697	193	112-0305	149	116-0040	159
111-0351	196	111-0702	193	114		116-0050	159
111-0353	197	111-0704	193	114-9091	143	116-0087	159
111-0355	197	111-0707	193	114-9093	143	116-0091	159
111-0357	197	111-0709	193	114-9179	143	116-0093	159
111-0359	197	111-0711	193	114-9181	143	116-0187	159
111-0402	193	111-0713	193	115		116-0188	159
111-0403	193	111-0715	193	115-1110	165	116-0207	157
111-0406	195	111-0717	193	115-1129	163	116-0208	157
111-0407	195	111-0719	193	115-1133	163	116-0210	157
111-0408	196	111-0722	193	115-1141	163	116-0212	157
111-0409	196	111-0724	193	115-1144	163	117	
111-0410	196	111-0726	193	115-1146	165	117-0199	145
111-0411	196	111-0728	193	115-1227	161	117-0201	145
111-0412	196	111-0821	195	115-1229	161	117-0203	145
111-0413	196	111-0822	195	115-1242	175	117-0205	145
111-0414	197	111-0823	195	115-1244	175	117-0207	145
111-0415	197	111-0824	195	115-1288	177	117-0209	145
111-0416	197	112		115-1292	177	117-0211	147
111-0417	197	112-0004	85	115-1309	177	117-0217	147
111-0418	197	112-0005	85	115-1311	177	118	
111-0419	197	112-0006	85	115-1313	177	118-0045	167
111-0420	195	112-0007	85	115-1315	177	118-0048	167
111-0421	195	112-0008	83	115-1323	178	118-0078	169
111-0422	196	112-0009	83	115-1324	178	118-0079	169
111-0423	196	112-0010	83	115-1342	175	118-0082	167

PRODUCT INDEX

Part ID	page	Part ID	page	Part ID	page	Part ID	page
118-0084.....	169	131-0145.....	93	132-0522.....	99	134-0816.....	125
127		131-0147.....	97	132-0524.....	99	134-0819.....	125
127-1218.....	249	131-0149.....	96	132-0526.....	101	134-0820.....	125
127-1220.....	249	131-9153.....	91	132-0528.....	101	134-0825.....	125
127-1231.....	253	131-9163.....	91	132-0530.....	101	134-0826.....	125
127-1233.....	253	131-9400.....	89	132-0532.....	99	134-0829.....	125
127-1235.....	253	131-9401.....	87	132-0534.....	99	134-0830.....	125
127-1237.....	253	131-9409.....	87	132-0536.....	101	134-1155.....	119
127-1257.....	247	131-9437.....	89	132-0538.....	101	134-1156.....	119
127-1259.....	247	131-9438.....	87	132-0540.....	101	134-1157.....	119
127-1261.....	251	131-9446.....	87	132-0542.....	99	134-1158.....	119
127-1263.....	251	131-9472.....	97	132-0544.....	99	134-1159.....	119
127-1269.....	255	131-9473.....	95	132-0546.....	101	134-1160.....	119
127-1271.....	255	131-9483.....	95	132-0548.....	101	134-1161.....	132
127-1273.....	255	131-9502.....	93	132-0550.....	101	134-1162.....	132
127-1275.....	255	131-9503.....	91	132-0552.....	99	134-1163.....	134
127-1287.....	253	131-9513.....	91	132-0554.....	99	134-1164.....	134
127-1289.....	253	131-9533.....	95	132-0556.....	101	134-1165.....	134
127-1291.....	253	131-9543.....	95	132-0558.....	101	134-1166.....	134
127-1293.....	253	132		132-0560.....	101	134-1167.....	134
127-1303.....	255	132-0083.....	103	133		134-1168.....	134
127-1305.....	255	132-0091.....	103	133-0075.....	74	134-1169.....	134
127-1307.....	255	132-0216.....	103	133-0076.....	74	134-1170.....	134
127-1309.....	255	132-0220.....	103	133-0077.....	74	134-1171.....	134
131		132-0226.....	105	133-0078.....	74	134-1172.....	134
131-0097.....	87	132-0241.....	105	133-0217.....	74	134-1173.....	134
131-0099.....	87	132-0254.....	105	133-0219.....	74	134-1174.....	134
131-0101.....	87	132-0294.....	103	133-0308.....	65	134-1175.....	134
131-0103.....	87	132-0319.....	103	133-0319.....	65	134-1176.....	134
131-0106.....	89	132-0330.....	103	133-0323.....	63	134-1177.....	134
131-0108.....	89	132-0331.....	103	133-0324.....	65	134-1178.....	134
131-0110.....	88	132-0332.....	103	133-0328.....	65	134-1179.....	134
131-0112.....	88	132-0333.....	103	133-0329.....	65	134-1180.....	134
131-0115.....	95	132-0334.....	105	133-0340.....	65	134-1181.....	134
131-0117.....	97	132-0335.....	105	133-0352.....	65	134-1182.....	134
131-0119.....	95	132-0336.....	105	133-0354.....	65	134-1183.....	134
131-0121.....	95	132-0337.....	105	133-0358.....	63	134-1210.....	121
131-0123.....	97	132-0339.....	105	133-0360.....	63	134-1211.....	121
131-0126.....	96	132-0403.....	103	133-0402.....	67	134-1253.....	117
131-0127.....	95	132-0438.....	103	133-0405.....	67	134-1256.....	117
131-0129.....	91	132-0458.....	103	134		134-1332.....	121
131-0131.....	93	132-0459.....	103	134-0797.....	132	134-1335.....	121
131-0133.....	92	132-0460.....	103	134-0798.....	132	134-1344.....	117
131-0135.....	91	132-0461.....	103	134-0802.....	125	134-1347.....	117
131-0137.....	91	132-0462.....	103	134-0803.....	125	134-1381.....	134
131-0139.....	93	132-0463.....	103	134-0805.....	125	134-1382.....	134
131-0141.....	92	132-0464.....	103	134-0806.....	125	134-1396.....	121
131-0143.....	91	132-0467.....	103	134-0815.....	125	134-1398.....	121

PRODUCT INDEX

Part ID	page	Part ID	page	Part ID	page	Part ID	page
134-1400	121	139		139-1196	311	139-1650	303
134-1402	121	139-0659	311	139-1197	311	139-1652	303
134-1424	129	139-0662	311	139-1198	311	139-1654	303
134-1425	129	139-0671	311	139-1199	311	139-1671	303
134-1426	129	139-0674	311	139-1200	311	139-1673	303
134-1427	129	139-0680	313	139-1201	311	139-1678	15
134-1432	129	139-0682	313	139-1202	317	139-1686	15
134-1433	129	139-0690	313	139-1204	315	139-1688	15
134-1434	129	139-0692	313	139-1205	315	139-1768	15
134-1435	129	139-0707	324	139-1206	315	139-1791	305
134-1440	134	139-0708	324	139-1207	315	139-1793	305
134-1441	134	139-0709	324	139-1218	317 / 321	139-1795	305
134-1442	134	139-0710	324	139-1219	324	139-1797	305
134-1444	134	139-0711	324	139-1221	324	139-1799	305
134-1445	134	139-0712	324	139-1222	324	139-1801	305
134-1449	134	139-0714	324	139-1223	324	139-1803	307
134-1456	131	139-0715	324	139-1226	324	139-1804	307
134-1457	131	139-0726	324	139-1227	324	139-1806	305
134-1458	131	139-0793	311	139-1228	324	139-1808	305
134-1459	131	139-0812	311	139-1229	324	139-1810	305
134-1460	131	139-0832	324	139-1230	324	139-1812	305
134-1461	131	139-0833	324	139-1231	324	139-1814	305
134-1470	131	139-0834	324	139-1233	324	139-1816	305
134-1471	131	139-0835	324	139-1238	324	139-1818	305
134-1472	131	139-0836	16 / 324	139-1239	324	139-1820	305
134-1473	131	139-0837	16 / 324	139-1240	324	139-1822	305
134-1476	131	139-0861	324	139-1241	324	139-1824	305
134-1477	131	139-0862	324	139-1242	324	139-1826	305
134-1478	131	139-0863	324	139-1246	317	139-1828	305
134-1479	131	139-0864	324	139-1412	319	139-1830	305
134-1483	123	139-0865	324	139-1414	319	139-1832	305
134-1491	134	139-0866	324	139-1416	319	139-1834	305
134-1492	134	139-0867	324	139-1443	309	139-1836	305
134-1497	132	139-0868	324	139-1444	309	139-1838	305
134-1498	132	139-0869	324	139-1445	309	139-1840	305
134-1596	127	139-0870	324	139-1446	309	139-1842	305
134-1598	127	139-0871	324	139-1447	309	139-1844	305
134-1600	127	139-0872	324	139-1448	309	139-1846	305
134-1602	127	139-1008	324	139-1450	303	139-1848	325
134-1605	127	139-1114	16 / 324	139-1463	321	139-1849	325
134-1611	117	139-1115	16 / 324	139-1464	321	139-1850	325
134-1625	121	139-1116	324	139-1465	321	139-1851	325
134-1627	121	139-1117	324	139-1565	303	139-1852	325
134-1631	121	139-1118	324	139-1603	322	139-1853	325
134-1633	121	139-1119	324	139-1634	15	139-1854	325
134-1639	132	139-1181	317	139-1641	303	139-1855	325
134-1640	132	139-1184	309	139-1642	303	139-1856	325
134-1641	132	139-1185	309	139-1643	303	139-1857	325

PRODUCT INDEX

Part ID	page	Part ID	page	Part ID	page	Part ID	page
139-1858	325	145-9190	280 / 281 / 296 / 297	146-0113	293	146-0512	289
139-1859	325	145-9192	280 / 281 / 296 / 297	146-0117	293	146-0515	289
139-1860	325	145-9194	281 / 297	146-0119	281 / 297	146-0530	269
139-1861	325	145-9196	294 / 300	146-0122	281 / 297	146-0533	269
139-1862	325	145-9200	294 / 300	146-0123	281 / 297	146-0623	280 / 296
139-1863	325	145-9211	271	146-0129	293	146-0624	280 / 296
139-1864	325	145-9215	271	146-0133	293	146-0625	280 / 296
139-1865	325	145-9479	282 / 301	146-0135	281 / 297	146-0626	280 / 296
145		145-9500	299	146-0138	281 / 297	146-0645	280 / 296
145-0030	280 / 296	145-9502	299	146-0141	281 / 297	146-0646	280 / 296
145-0031	291	145-9504	299	146-0156	280 / 281 / 296 / 297	146-7050	291
145-0034	291	145-9506	299	146-0157	281 / 297	146-7052	291
145-0037	289	145-9509	273	146-0158	280 / 281 / 296 / 297	146-7054	289
145-0040	289	145-9511	273	146-0184	293	146-7056	289
145-0043	269	145-9513	273	146-0200	293	146-7058	269
145-0046	269	145-9515	273	146-0229	280 / 281 / 296 / 297	146-7060	269
145-0050	280 / 296	145-9530	282 / 301	146-0230	281 / 297	146-7062	291
145-0052	291	145-9531	282 / 301	146-0231	280 / 281 / 296 / 297	146-7064	291
145-0055	291	145-9532	282 / 301	146-0241	364	146-7066	289
145-0070	289	145-9533	282 / 301	146-0242	364	146-7068	289
145-0073	289	145-9534	282 / 301	146-0243	364	146-7070	269
145-0088	269	145-9549	299	146-0244	364	146-7072	269
145-0091	269	145-9550	299	146-0245	294	146-9622	271
145-0142	280 / 296	145-9556	273	146-0246	294	146-9630	271
145-0143	280 / 296	145-9557	273	146-0247	294	146-9650	271
145-0145	280 / 296	145-9570	282 / 301	146-0248	294	146-9672	271
145-9002	293	145-9571	282 / 301	146-0251	294	146-9676	271
145-9004	293	145-9572	282 / 301	146-0253	294	146-9682	271
145-9006	293	145-9573	282 / 301	146-0257	281 / 297	147	
145-9012	293	145-9574	282 / 301	146-0258	281 / 297	147-0001	348
145-9014	293	145-9577	282 / 301	146-0259	281 / 297	147-0002	348
145-9016	293	145-9604	299	146-0260	281 / 297	147-0004	348
145-9032	271	145-9605	299	146-0261	281 / 297	147-0005	348
145-9036	271	145-9608	273	146-0262	281 / 297	147-0011	349
145-9040	271	145-9609	273	146-0263	281 / 297	147-0013	349
145-9062	271	145-9791	299	146-0264	281 / 297	147-0019	349
145-9066	271	145-9792	299	146-0397	280 / 296	147-0022	349
145-9070	271	145-9793	299	146-0398	280 / 296	147-0023	323 / 354 / 366
145-9073	293	145-9809	273	146-0399	291	147-0024	323 / 354 / 366
145-9075	293	145-9810	273	146-0402	291	147-0025	323 / 366
145-9077	293	145-9811	273	146-0405	289	147-0096	323 / 354 / 366
145-9170	281 / 297	145-9830	282 / 301	146-0408	289	147-0097	323 / 354 / 366
145-9172	281 / 297	145-9831	282 / 301	146-0411	269	147-0098	323
145-9174	281 / 297	145-9832	282 / 301	146-0414	269	147-0099	323
145-9176	281 / 297	145-9833	282 / 301	146-0418	280 / 296	147-0100	323
145-9178	281 / 297	145-9834	282 / 301	146-0439	280 / 296	147-0105	323 / 354 / 366
145-9180	281 / 297	145-9846	282 / 301	146-0494	291	147-0148	323 / 354 / 366
145-9182	281 / 297	146		146-0497	291	147-0164	348

PRODUCT INDEX

Part ID	page	Part ID	page	Part ID	page	Part ID	page
147-0173	349	147-0513	348	148-9048	332	161-9115	284 / 338
147-0176	348	147-0516	348	148-9050	332	161-9116	284 / 338
147-0177	348	147-0517	348	148-9052	332	161-9117	284 / 338
147-0183	348	147-0526	322 / 336 / 352 / 364	148-9078	333	161-9118	284 / 338
147-0187	348	147-0527	322 / 336 / 352 / 364	148-9080	333	161-9119	284 / 338
147-0213	354 / 366	147-0543	322 / 336 / 352 / 364	148-9082	333	161-9121	284 / 338
147-0224	349	147-0544	322 / 336 / 352 / 364	148-9096	334	161-9126	284 / 338
147-0228	348	147-0545	322 / 336 / 352 / 364	148-9098	334	161-9127	284 / 338
147-0229	348	147-0546	322 / 336 / 352 / 364	148-9106	335	161-9128	284 / 338
147-0231	348	147-0547	322 / 336 / 352 / 364	148-9108	335	161-9129	284 / 338
147-0233	348	147-0548	322 / 336 / 352 / 364	148-9226	338	161-9130	284 / 338
147-0235	349	147-0549	322 / 336 / 352 / 364	148-9230	338	161-9131	284 / 338
147-0240	349	147-0550	322 / 336 / 352 / 364	148-9231	338	161-9162	329
147-0268	348	147-0551	322 / 336 / 352 / 364	148-9236	338	161-9166	329
147-0334	347	147-0552	322 / 336 / 352 / 364	148-9237	338	161-9183	332
147-0335	347	147-0556	354 / 366	148-9240	338	161-9186	332
147-0336	347	147-0557	354 / 366	148-9241	338	161-9192	332
147-0337	347	147-0655	204 / 240 / 356	148-9242	338	161-9195	332
147-0338	347	147-0656	204 / 240 / 356	148-9243	338	161-9201	333
147-0339	347	147-0657	356	148-9260	338	161-9204	333
147-0346	348	147-0680	343	148-9262	338	161-9210	333
147-0347	348	147-0682	345	148-9266	338	161-9213	333
147-0352	348	147-0684	344	155		161-9219	334
147-0360	350	147-0686	343	155-0266	182	161-9222	334
147-0361	351	147-0688	345	155-0269	182	161-9228	334
147-0365	350	147-0690	344	155-0304	182	161-9231	334
147-0367	350	147-0692	343	155-0306	182	161-9239	332
147-0371	322 / 352	147-0694	345	155-0550	182	161-9243	333
147-0372	322 / 352	147-0696	344	155-0551	182	161-9252	331
147-0373	322 / 352	147-0698	343	159		161-9255	331
147-0374	322 / 352	147-0700	345	159-0299	181	161-9258	331
147-0376	348	147-0702	344	159-0303	181	161-9261	331
147-0397	354	147-0704	343	159-0307	181	161-9284	329
147-0398	354	147-0706	345	159-0309	181	161-9288	329
147-0404	354	147-0708	344	161		161-9323	332
147-0410	240 / 356	147-0710	343	161-7300	275	161-9326	332
147-0465	354 / 366	147-0712	345	161-7304	275	161-9350	332
147-0481	348	147-0714	344	161-7308	275	161-9353	332
147-0483	349	147-0716	343	161-7332	275	161-9392	333
147-0485	348	147-0718	345	161-7336	275	161-9395	333
147-0487	349	147-0720	344	161-7360	275	161-9419	333
147-0489	350	147-0722	343	161-7364	275	161-9422	333
147-0490	350	147-0724	345	161-7388	277	161-9440	334
147-0504	347	147-0726	344	161-7392	277	161-9443	334
147-0507	348	148		161-7406	277	161-9452	334
147-0508	348	148-9018	331	161-7410	277	161-9455	334
147-0510	347	148-9020	331	161-7414	277	161-9461	335
147-0511	348	148-9022	331	161-9113	284 / 338	161-9464	335

PRODUCT INDEX

Part ID	page	Part ID	page	Part ID	page	Part ID	page
161-9470.....	335	185-0877.....	53	185-1634.....	53	185-2719.....	52
161-9473.....	335	185-0884.....	53	185-1635.....	53	185-2723.....	31
161-9544.....	338	185-0885.....	53	185-1637.....	53	185-2726.....	31
161-9546.....	338	185-0886.....	53	185-1638.....	53	185-2770.....	27
161-9547.....	338	185-0891.....	53	185-1639.....	53	185-2772.....	27
161-9548.....	338	185-0892.....	53	185-1640.....	53	185-2777.....	27
161-9549.....	338	185-0893.....	53	185-1641.....	53	185-2778.....	27
161-9550.....	338	185-0894.....	53	185-1642.....	53	185-2779.....	27
161-9551.....	338	185-0895.....	52	185-1643.....	53	185-2843.....	25
161-9552.....	338	185-0896.....	53	185-1644.....	53	185-2865.....	52
161-9555.....	338	185-0897.....	53	185-1645.....	53	185-2866.....	52
161-9556.....	338	185-0898.....	53	185-1850.....	48	185-2867.....	52
161-9557.....	338	185-0899.....	52	185-1855.....	48	185-2869.....	52
161-9558.....	338	185-0900.....	53	185-2349.....	33	185-2870.....	52
161-9563.....	338	185-0901.....	53	185-2350.....	33	185-2871.....	52
161-9726.....	334	185-0902.....	53	185-2351.....	33	185-2884.....	16 / 50 / 303
161-9732.....	335	185-0904.....	53	185-2352.....	33	185-2885.....	16 / 50 / 303
161-9735.....	335	185-0905.....	53	185-2354.....	29	185-2908.....	37
161-9738.....	335	185-0906.....	53	185-2360.....	29	185-2909.....	37
161-9741.....	335	185-0908.....	53	185-2400.....	33	185-3003.....	23
161-9745.....	335	185-0909.....	53	185-2402.....	33	185-3077.....	23
161-9748.....	331	185-0910.....	53	185-2441.....	33	185-3079.....	23
161-9832.....	331	185-0912.....	53	185-2443.....	33	185-3081.....	23
161-9835.....	331	185-0923.....	48	185-2446.....	31	185-3084.....	23
161-9861.....	331	185-0924.....	48	185-2457.....	53	185-3086.....	23
161-9864.....	331	185-1036.....	48	185-2458.....	53	185-3091.....	31
185		185-1483.....	29	185-2459.....	53	185-3093.....	31
185-0322.....	48	185-1528.....	29	185-2460.....	53	185-3095.....	35
185-0323.....	48	185-1548.....	309	185-2461.....	53	185-7592.....	31
185-0325.....	48	185-1557.....	25	185-2462.....	53	185-7593.....	31
185-0326.....	48	185-1558.....	25	185-2463.....	53	185-7682.....	31
185-0412.....	48	185-1559.....	25	185-2464.....	53	185-9546.....	48
185-0414.....	48	185-1560.....	25	185-2465.....	53	185-9612.....	52
185-0415.....	53	185-1562.....	25	185-2466.....	53	186	
185-0419.....	53	185-1576.....	29	185-2467.....	53	186-0043.....	45
185-0727.....	53	185-1577.....	29	185-2468.....	53	186-0044.....	45
185-0728.....	53	185-1579.....	29	185-2526.....	21	186-0054.....	43
185-0749.....	29	185-1584.....	29	185-2559.....	21	186-0059.....	43
185-0757.....	29	185-1588.....	29	185-2576.....	35	186-0060.....	43
185-0789.....	53	185-1589.....	29	185-2583.....	35	186-0065.....	43
185-0790.....	53	185-1591.....	29	185-2591.....	31	186-0066.....	43
185-0791.....	53	185-1596.....	29	185-2600.....	31	186-0072.....	43
185-0793.....	53	185-1622.....	48	185-2603.....	31	186-0082.....	43
185-0794.....	53	185-1623.....	48	185-2632.....	52 / 134	186-0097.....	47
185-0795.....	53	185-1624.....	50	185-2658.....	31	186-0098.....	47
185-0796.....	48	185-1625.....	53	185-2661.....	31	186-0099.....	47
185-0797.....	48	185-1626.....	53	185-2688.....	35	186-0100.....	47
185-0876.....	53	185-1632.....	53	185-2691.....	35	186-0101.....	48

PRODUCT INDEX

Part ID	page	Part ID	page	Part ID	page	Part ID	page
186-0102	48	187-0007	80	197-0134	74	240-0607	387
186-0103	48	187-0008	80	197-0324	72	240-0627	388
186-0123	43	187-0009	80	197-0326	73	240-0628	389
186-0124	43	187-0010	80	197-0327	73	240-0629	389
186-0236	39	187-0011	80	197-0329	73	240-0630	389
186-0239	39	187-0012	80	197-0367	71	240-0631	389
186-0242	40	187-0014	81	197-9081	69	240-0632	389
186-0245	40	187-0015	81	240		240-0633	389
186-0248	41	187-0016	81	240-0104	385	240-0634	389
186-0251	39	187-0023	79	240-0108	385	240-0635	389
186-0253	39	187-0024	79	240-0186	388	240-0636	389
186-0254	39	187-0025	79	240-0200	388	240-0659	388
186-0256	39	187-0026	79	240-0206	388	240-0667	384
186-0257	40	187-0027	79	240-0221	390	240-0679	385
186-0259	40	187-0028	79	240-0226	390	240-0696	384
186-0260	40	187-0029	80	240-0233	390	240-0699	388
186-0262	40	187-0030	80	240-0238	390	240-0731	385
186-0263	41	187-0320	79	240-0242	390	240-0949	385
186-0265	41	187-0321	79	240-0248	390	240-1149	392
186-0266	39	187-0322	79	240-0345	388	240-1150	392
186-0268	39	187-0323	79	240-0381	384	240-1151	392
186-0269	39	187-0324	79	240-0394	384	240-1152	392
186-0271	39	190		240-0395	384	240-1153	392
186-0272	40	190-9002	59	240-0481	384	240-1154	392
186-0274	40	190-9005	59	240-0484	388	240-1450	386
186-0275	40	190-9008	61	240-0498	384	240-1451	386
186-0277	40	190-9011	61	240-0511	388	240-1452	386
186-0278	41	190-9014	59	240-0528	385	240-1453	386
186-0280	41	190-9017	59	240-0536	388	240-1454	386
186-0281	48	190-9030	74	240-0561	388	240-1455	386
186-0282	48	190-9031	74	240-0584	386	240-1456	386
186-0283	48	195		240-0585	386	240-1459	386
186-0284	48	195-0191	74	240-0586	386	250	
186-0285	48	195-0193	74	240-0587	386	250-0089	380
186-0286	48	195-9146	57	240-0588	386	250-0091	380
186-0287	48	195-9521	111	240-0589	386	250-0099	380
186-0288	48	195-9524	111	240-0590	386	250-0488	383
186-0289	48	195-9533	113	240-0594	387	250-0489	383
186-0290	48	195-9536	111	240-0595	387	250-0490	383
186-0291	48	195-9539	111	240-0596	387	250-0491	383
186-0292	48	195-9548	113	240-0597	387	250-0492	383
187		197		240-0598	387	250-0513	383
187-0001	79	197-0041	69	240-0599	387	250-0543	381
187-0002	79	197-0129	74	240-0600	387	250-0545	381
187-0003	79	197-0130	74	240-0601	387	250-0547	381
187-0004	79	197-0131	74	240-0602	387	250-0549	381
187-0005	80	197-0132	74	240-0603	387	250-0551	381
187-0006	80	197-0133	74	240-0606	387	250-0553	381

PRODUCT INDEX

Part ID	page	Part ID	page	Part ID	page	Part ID	page
250-0628.....	380	300-0168.....	258	300-0949.....	170	400-0259.....	372
250-0641.....	382	300-0169.....	258	300-1019.....	396	400-0261.....	372
250-0642.....	382	300-0170.....	258	300-1048.....	396	400-0271.....	323 / 337 / 352 / 372
250-0643.....	382	300-0172.....	258	300-1167.....	152	400-0301.....	323 / 337 / 373
250-0644.....	382	300-0190.....	258	300-1168.....	152	400-0302.....	50
250-0645.....	382	300-0191.....	258	310		400-0309.....	50
250-0646.....	382	300-0192.....	258	310-9000.....	294	400-0310.....	16 / 50 / 303
260		300-0198.....	336	310-9200.....	278	400-0311.....	16 / 50 / 303
260-0001.....	394	300-0201.....	336	310-9202.....	278	400-0319.....	373
260-0003.....	394	300-0203.....	336	310-9210.....	278	405	
260-0004.....	394	300-0207.....	336	310-9212.....	278	405-0025.....	376
260-0008.....	394	300-0321.....	396	310-9220.....	278	405-0026.....	376
260-0013.....	394	300-0323.....	396	310-9222.....	278	405-0028.....	376
260-0015.....	394	300-0325.....	396	310-9230.....	279	405-0032.....	376
260-0018.....	394	300-0329.....	396	310-9232.....	279	405-0033.....	376
260-0019.....	394	300-0331.....	396	310-9240.....	279	405-0035.....	376
260-0021.....	394	300-0333.....	397	310-9242.....	279	405-0039.....	376
260-0055.....	394	300-0336.....	397	310-9250.....	279	405-0040.....	376
260-0056.....	394	300-0338.....	397	310-9252.....	279	405-0041.....	376
270		300-0341.....	397	310-9260.....	279	405-0042.....	376
270-9038.....	322 / 336 / 352 / 364	300-0343.....	397	310-9264.....	279	405-0043.....	376
270-9039.....	322 / 336	300-0345.....	397	310-9270.....	279	405-0078.....	377
300		300-0353.....	397	310-9274.....	279	405-0088.....	376
300-0022.....	397	300-0355.....	397	310-9280.....	279	405-0112.....	377
300-0023.....	397	300-0358.....	397	310-9284.....	279	405-0113.....	377
300-0024.....	397	300-0359.....	397	310-9290.....	278	405-0122.....	263
300-0063.....	259	300-0360.....	397	310-9294.....	278	405-0142.....	377
300-0064.....	259	300-0456.....	170	400		430	
300-0066.....	259	300-0461.....	152 / 294 / 300 / 322	400-0003.....	372	430-0001.....	262 / 264
300-0069.....	259	/ 336 / 352 / 364	400-0018.....	372	430-0002.....	262 / 265
300-0070.....	259	300-0464.....	152	400-0021.....	372		
300-0083.....	257	300-0477.....	259	400-0033.....	372		
300-0084.....	257	300-0556.....	397	400-0035.....	372		
300-0085.....	257	300-0558.....	397	400-0037.....	372		
300-0086.....	257	300-0559.....	397	400-0042.....	372		
300-0089.....	256	300-0586.....	152	400-0046.....	372		
300-0090.....	256	300-0765.....	259	400-0053.....	372		
300-0093.....	256	300-0766.....	259	400-0056.....	372		
300-0099.....	256	300-0767.....	256	400-0058.....	372		
300-0104.....	256	300-0768.....	256	400-0065.....	372		
300-0109.....	256	300-0769.....	256	400-0075.....	372		
300-0138.....	257	300-0770.....	256	400-0080.....	372		
300-0141.....	257	300-0771.....	256	400-0092.....	372		
300-0144.....	257	300-0790.....	396	400-0121.....	323 / 337 / 372		
300-0146.....	257	300-0791.....	396	400-0126.....	337 / 372		
300-0149.....	256	300-0802.....	396	400-0140.....	372		
300-0152.....	256	300-0803.....	396	400-0173.....	337 / 373		
300-0165.....	258	300-0808.....	256	400-0180.....	323 / 337 / 352 / 373		

www.we-ef.com



WE-EF LEUCHTEN

Germany
Telephone +49 5194 909 0
Facsimile +49 5194 909 299
info.germany@we-ef.com

WE-EF LUMIERE

France
Telephone +33 4 74 99 14 44
Facsimile +33 4 74 99 14 40
info.france@we-ef.com

WE-EF HELVETICA

Switzerland
Telephone +41 22 752 49 94
Facsimile +41 22 752 49 74
info.switzerland@we-ef.com

WE-EF LIGHTING

United Kingdom
Telephone +44 844 880 5346
Facsimile +44 844 880 5347
info.uk@we-ef.com

WE-EF LIGHTING

Thailand
Telephone +66 2 738 9610
Facsimile +66 2 175 2174
info.asiapacific@we-ef.com

WE-EF LIGHTING

Australia
Telephone +61 3 8587 0444
Facsimile +61 3 8587 0499
info.australia@we-ef.com

WE-EF LIGHTING

United States of America
Telephone +1 724 742 0030
Facsimile +1 724 742 0035
info.usa@we-ef.com

Product specifications given in this catalogue reflect the status as of March 2016. Errors and omissions are excepted. Data given can be subject to change without prior notice.

The conditions of sale, as published in WE-EF's current price lists and/or business forms apply. Export transactions require special agreements, particularly regarding shipment and payment.

Catalogue

European Edition 2016-2018

© Copyright WE-EF 2016

Conception/Text

WE-EF LEUCHTEN GmbH & Co. KG, Bisingen, Germany

Product Photography

Andreas Pletz FOTO, Jürgenstorf, Germany

Prepress

MEGS LITHO Bildbearbeitung + Produktion, Lüneburg, Germany

Printing

v. Stern'sche Druckerei GmbH & Co KG, Lüneburg, Germany

Printed on 100% chlorine free paper.

WE-EF Farben | Colours | Couleurs

	RAL 9004 Signalschwarz Signal black Noir de sécurité		RAL 7015 Schiefergrau Slate grey Gris ardoise
	RAL 9006 Weißaluminium White aluminium Aluminium blanc		RAL 7022 Umbragrau Umbr grey Gris terre d'ombre
	RAL 9007 Graualuminium Grey aluminium Aluminium gris		RAL 7024 Graphitgrau Graphite grey Gris graphite
	RAL 7016 Anthrazitgrau Anthracite grey Gris anthracite		RAL 7030 Steingrau Stone grey Gris pierre
	RAL 9016 Verkehrsweiß Traffic white Blanc signalisation		RAL 7032 Kieselgrau Pebble grey Gris silex
	Classic Silver		RAL 7035 Lichtgrau Light grey Gris clair
	RAL 1015 Hellelfenbein Light ivory Ivoire clair		RAL 7037 Staubgrau Dusty grey Gris poussière
	RAL 3002 Karminrot Carmine red Rouge carmin		RAL 7043 Verkehrsgrau B Traffic grey B Gris signalisation B
	RAL 3004 Purpurrot Purple red Rouge pourpre		RAL 7045 Telegrau 1 Telegrey 1 Telegris 1
	RAL 3005 Weinrot Wine red Rouge vin		RAL 8004 Kupferbraun Copper brown Brun cuivré
	RAL 3011 Braunrot Brown red Rouge brun		RAL 8017 Schokoladenbraun Chocolate brown Brun chocolat
	RAL 3020 Verkehrsrot Traffic red Rouge signalisation		RAL 8019 Graubraun Grey brown Brun gris
	RAL 5003 Saphirblau Sapphire blue Bleu saphir		RAL 9005 Tiefschwarz Jet black Noir foncé
	RAL 5004 Schwarzblau Black blue Bleu noir		RAL 9010 Reinweiß Pure white Blanc pur
	RAL 5014 Taubenblau Pigeon blue Bleu pigeon		RAL 9018 Papyrusweiß Papyrus white Blanc papyrus
	RAL 5023 Fernblau Distant blue Bleu distant		DB 501 WE-EF 51 Gris bleu clair
	RAL 6005 Moosgrün Moss green Vert mousse		DB 502 WE-EF 52 Gris bleu foncé
	RAL 6009 Tannengrün Fir green Vert sapin		DB 701 WE-EF 71 Gris clair
	RAL 6011 Resedagrün Reseda green Vert réséda		DB 702 WE-EF 72 Gris moyen
	RAL 6012 Schwarzgrün Black green Vert noir		DB 703 WE-EF 73 Gris foncé
	RAL 6021 Blassgrün Pale green Vert pâle		
	RAL 7006 Beigegrau Beige grey Gris beige		
	RAL 7011 Eisengrau Iron grey Gris fer		
	RAL 7012 Basaltgrau Basalt grey Gris basalte		

Geringe Abweichungen in Farbton und Glanz sind drucktechnisch bedingt. Maßgeblich für RAL-Farben sind allein die RAL-Register 840-HR (seidenmatt) oder 841-GL (glänzend). **Gültig ab Juli 2017**

The colour shades and gloss levels are for guidance only. For accurate colour matching, use the official 840-HR (semi-gloss) and 841-GL (gloss) reference charts. **Valid from July 2017**

Un léger écart de couleur est dû aux techniques d'imprimerie. L'origine des couleurs RAL provient du registre RAL-840-HR (brillant satiné) ou 841-GL (brillant). **Valable à partir d' Juillet 2017**

WE-EF LEUCHTEN

GmbH & Co. KG

Toepinger Strasse 16

29646 Bispingen

Germany

Tel +49 5194 909 0

Fax +49 5194 909 299

info.germany@we-ef.com

www.we-ef.com