

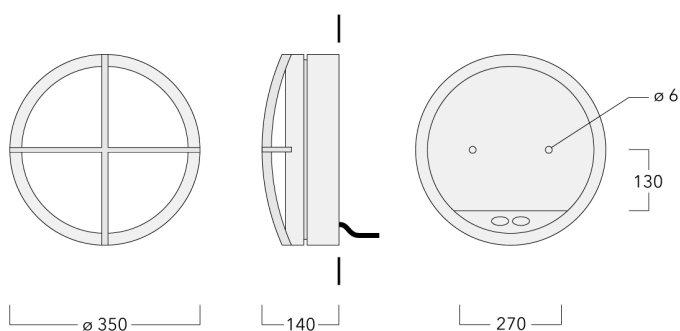



Description

IP55, Class I. Class II on request. IK10. Marine-grade, die-cast aluminium alloy. 5CE superior corrosion protection including PCS hardware. Silicone rubber gasket. Polycarbonate main lens. Two cable entries. Factory installed LED circuit board. Integral EC electronic converter.



Specifications

Material description

Body	Marine-grade die-cast aluminium alloy																
Lens	Polycarbonate lens																
Colours	<table><tr><td>RAL9004</td><td>RAL9006</td><td>RAL9016</td><td>RAL7016</td></tr><tr><td>Signal black</td><td>White aluminium</td><td>Traffic white</td><td>Anthracite grey</td></tr><tr><td>RAL9007</td><td></td><td></td><td></td></tr><tr><td>Grey aluminium</td><td></td><td></td><td></td></tr></table>	RAL9004	RAL9006	RAL9016	RAL7016	Signal black	White aluminium	Traffic white	Anthracite grey	RAL9007				Grey aluminium			
RAL9004	RAL9006	RAL9016	RAL7016														
Signal black	White aluminium	Traffic white	Anthracite grey														
RAL9007																	
Grey aluminium																	
Gasket	Silicone rubber gasket																
Fasteners	PCS Polymer Coated Stainless Steel Hardware																
Ingress protection	IP55																
Impact resistance	IK10																
Corrosion resistance	5CE																

Electrical description

Power supply	220-240V / 50-60 Hz
Driver / Ballast	Integral EC electronic converter
Surge protection	1/2 kV
Energy efficiency	D (Light source)

Additional information

Lifetime	Ta=25° L70B50 > 50000h
----------	------------------------

Options

Light distribution **Colour temperature** **Nominal Watt**

[]



3000K

28 W



4000K



2700K

Configurations

Light distribution	Part ID	Light source	Rated lumens	Rated input power	CRI
[]	195-0896	LED-1/28W/2700K	1457.7 lm	28 W	80
	195-9539	LED-1/28W/3000K	1518.3 lm	28 W	80
	195-9540	LED-1/28W/4000K	1585.2 lm	28 W	80