



**Description**

IP66. Class I. IK08. Marine-grade, die-cast aluminium alloy. 5CE superior corrosion protection including PCS hardware. Safety glass lens, hinged. Silicone CCG® Controlled Compression Gasket.

Integral EC electronic converter. Advanced thermal management protects LEDs while optimising lumens output. LED board can be easily removed for upgrading. CAD-optimised optics for superior illumination and glare control. OLC® One LED Concept.

Maximum spacing for streetlighting applications depends on wattage and light distribution: 5.5 to 9 times the mounting height.

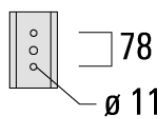
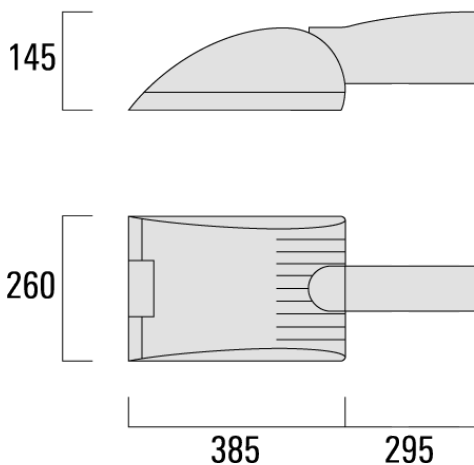

## Specifications

### Material description

Body	Marine-grade, die-cast aluminium alloy								
Lens	Safety glass lens, hinged								
Colours	<table><tr><td><b>RAL9004</b></td><td><b>RAL9016</b></td><td><b>RAL7016</b></td><td><b>RAL9007</b></td></tr><tr><td>Signal black</td><td>Traffic white</td><td>Anthracite grey</td><td>Grey aluminium</td></tr></table>	<b>RAL9004</b>	<b>RAL9016</b>	<b>RAL7016</b>	<b>RAL9007</b>	Signal black	Traffic white	Anthracite grey	Grey aluminium
<b>RAL9004</b>	<b>RAL9016</b>	<b>RAL7016</b>	<b>RAL9007</b>						
Signal black	Traffic white	Anthracite grey	Grey aluminium						
Gasket	Silicone CCG® Controlled Compression Gasket								
Fasteners	PCS hardware								
Corrosion resistance	5CE								

### Electrical description

Power supply	220-240V / 50-60 Hz
Driver / Ballast	Integral EC electronic converter, including 6/6 kV surge protection

### Additional information

Windage	0.072 m <sup>2</sup>
---------	----------------------

**Options**

**Light distribution**

 [P65] pedestrian/bicycle lane

 [S60] asymmetric, side throw

 [S65] asymmetric, side throw

 [S70] asymmetric, side throw

 [A60] asymmetric, forward throw

 [R65] rectangular, side throw

**Colour temperature**

 3000K

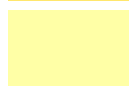





 4000K

**Nominal Watt**

36 W

54 W

## Configurations

Light distribution	Part ID	Light source	Rated lumens	Rated input power	CRI
 [A60] asymmetric, forward throw	108-7749	LED-18/36W/3000K	3899.5 lm	36 W	80
	108-7750	LED-18/36W/4000K	4168.4 lm	36 W	80
	108-7759	LED-18/54W/3000K	5782 lm	54 W	80
	108-7760	LED-18/54W/4000K	6051.1 lm	54 W	80
 [P65] pedestrian/bicycle lane	108-7805	LED-18/36W/3000K	4049.1 lm	36 W	80
	108-7806	LED-18/36W/4000K	4328.4 lm	36 W	80
	108-7807	LED-18/54W/3000K	6003.9 lm	54 W	80
	108-7808	LED-18/54W/4000K	6283.3 lm	54 W	80
 [R65] rectangular, side throw	108-7747	LED-18/36W/3000K	3810.7 lm	36 W	80
	108-7748	LED-18/36W/4000K	4073.5 lm	36 W	80
	108-7757	LED-18/54W/3000K	5650.3 lm	54 W	80
	108-7758	LED-18/54W/4000K	5913.3 lm	54 W	80
 [S60] asymmetric, side throw	108-7741	LED-18/36W/3000K	4158.4 lm	36 W	80
	108-7742	LED-18/36W/4000K	4445.2 lm	36 W	80
	108-7751	LED-18/54W/3000K	6165.9 lm	54 W	80
	108-7752	LED-18/54W/4000K	6452.9 lm	54 W	80
 [S65] asymmetric, side throw	108-7743	LED-18/36W/3000K	4182.7 lm	36 W	80
	108-7744	LED-18/36W/4000K	4471.2 lm	36 W	80
	108-7753	LED-18/54W/3000K	6202 lm	54 W	80
	108-7754	LED-18/54W/4000K	6490.7 lm	54 W	80
 [S70] asymmetric, side throw	108-7745	LED-18/36W/3000K	4052.8 lm	36 W	80
	108-7746	LED-18/36W/4000K	4332.4 lm	36 W	80
	108-7755	LED-18/54W/3000K	6009.4 lm	54 W	80
	108-7756	LED-18/54W/4000K	6289.1 lm	54 W	80