



**Description**

IP66. Class I. IK08. Marine-grade, die-cast aluminium alloy. 5CE superior corrosion protection including PCS hardware. Safety glass lens, hinged. Silicone CCG® Controlled Compression Gasket.

Integral EC electronic converter. Advanced thermal management protects LEDs while optimising lumens output. LED board can be easily removed for upgrading. CAD-optimised optics for superior illumination and glare control. OLC® One LED Concept.

Maximum spacing for streetlighting applications depends on wattage and light distribution: 5.5 to 9 times the mounting height.

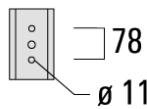
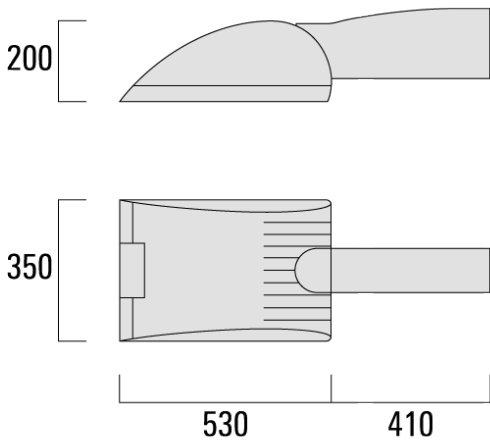

## Specifications

### Material description

Body	Marine-grade, die-cast aluminium alloy								
Lens	Safety glass lens, hinged								
Colours	<table><tr><td><b>RAL9004</b></td><td><b>RAL9016</b></td><td><b>RAL7016</b></td><td><b>RAL9007</b></td></tr><tr><td>Signal black</td><td>Traffic white</td><td>Anthracite grey</td><td>Grey aluminium</td></tr></table>	<b>RAL9004</b>	<b>RAL9016</b>	<b>RAL7016</b>	<b>RAL9007</b>	Signal black	Traffic white	Anthracite grey	Grey aluminium
<b>RAL9004</b>	<b>RAL9016</b>	<b>RAL7016</b>	<b>RAL9007</b>						
Signal black	Traffic white	Anthracite grey	Grey aluminium						
Gasket	Silicone CCG® Controlled Compression Gasket								
Fasteners	PCS hardware								
Corrosion resistance	5CE								

### Electrical description

Driver / Ballast	Integral EC electronic converter, including 6/6 kV surge protection
------------------	---

### Additional information

Windage	0.109 m <sup>2</sup>
---------	----------------------

**Options**

**Light distribution**

 [P65] pedestrian/bicycle lane

 [S60] asymmetric, side throw

 [S65] asymmetric, side throw

 [S70] asymmetric, side throw

 [A60] asymmetric, forward throw

 [R65] rectangular, side throw

**Colour temperature**



3000K

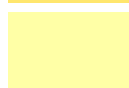







4000K

**Nominal Watt**

72 W

108 W

## Configurations

Light distribution	Part ID	Light source	Rated lumens	Rated input power	CRI
 [A60] asymmetric, forward throw	108-7770	LED-36/72W/3000K	7798.9 lm	72 W	80
	108-7771	LED-36/72W/4000K	8336.8 lm	72 W	80
	108-7780	LED-36/108W/3000K	11563.9 lm	108 W	80
	108-7781	LED-36/108W/4000K	12101.8 lm	108 W	80
 [P65] pedestrian/bicycle lane	108-7810	LED-36/72W/3000K	8098.2 lm	72 W	80
	108-7811	LED-36/72W/4000K	8656.7 lm	72 W	80
	108-7812	LED-36/108W/3000K	12007.7 lm	108 W	80
	108-7813	LED-36/108W/4000K	12566.2 lm	108 W	80
 [R65] rectangular, side throw	108-7768	LED-36/72W/3000K	7621.4 lm	72 W	80
	108-7769	LED-36/72W/4000K	8147 lm	72 W	80
	108-7778	LED-36/108W/3000K	11300.6 lm	108 W	80
	108-7779	LED-36/108W/4000K	11826.3 lm	108 W	80
 [S60] asymmetric, side throw	108-7762	LED-36/72W/3000K	8316.8 lm	72 W	80
	108-7763	LED-36/72W/4000K	8890.4 lm	72 W	80
	108-7772	LED-36/108W/3000K	12331.8 lm	108 W	80
	108-7773	LED-36/108W/4000K	12905.4 lm	108 W	80
 [S65] asymmetric, side throw	108-7764	LED-36/72W/3000K	8365.5 lm	72 W	80
	108-7765	LED-36/72W/4000K	8942.4 lm	72 W	80
	108-7774	LED-36/108W/3000K	12404 lm	108 W	80
	108-7775	LED-36/108W/4000K	12980.9 lm	108 W	80
 [S70] asymmetric, side throw	108-7766	LED-36/72W/3000K	8105.7 lm	72 W	80
	108-7767	LED-36/72W/4000K	8664.7 lm	72 W	80
	108-7776	LED-36/108W/3000K	12018.8 lm	108 W	80
	108-7777	LED-36/108W/4000K	12577.8 lm	108 W	80