

Description

IP66, Class I. IK08. Marine-grade, die-cast aluminium alloy. 5CE superior corrosion protection including PCS hardware. Safety glass lens, hinged. Silicone CCG® Controlled Compression Gasket. Luminaire is factory-sealed and does not need to be opened during installation.

Integral EC electronic converter in thermally-separated compartment. Advanced thermal management protects LEDs while optimising lumens output. CAD-optimised optics for superior illumination and glare control. OLC® One LED Concept.

Including terminal box, for mounting on \varnothing 48-60 mm pipes or space frames.

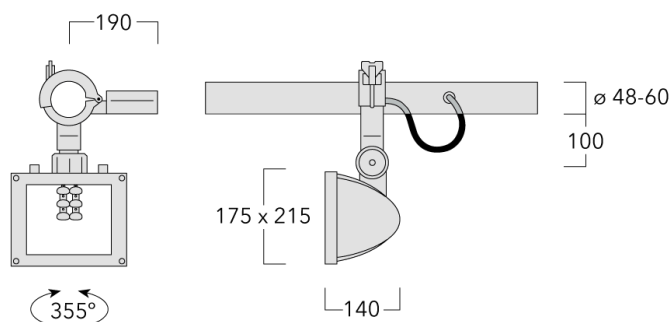

Specifications

Material description

Colours	RAL9004 Signal black	RAL7016 Anthracite grey	RAL9016 Traffic white	RAL9007 Grey aluminium
Ingress protection	IP66			
Impact resistance	IK08			

Electrical description

Driver / Ballast	Integral EC electronic converter in thermally-separated compartment
------------------	---

Additional information

Options

Light distribution

 [P65] pedestrian/bicycle lane

 [S70] asymmetric, side throw

 [A60] asymmetric, forward throw

 [R65] rectangular, side throw

Colour temperature

 3000K





 4000K

Nominal Watt

18 W

26 W

Configurations

Light distribution	Part ID	Light source	Rated lumens	Rated input power	CRI
 [A60] asymmetric, forward throw	161-5984	LED-6/18W/3000K	1468.7 lm	18 W	80
	161-5986	LED-6/18W/4000K	1537 lm	18 W	80
	161-5985	LED-6/26W/3000K	1878.6 lm	26 W	80
	161-5987	LED-6/26W/4000K	1964 lm	26 W	80
 [P65] pedestrian/bicycle lane	161-5976	LED-6/18W/3000K	1523.7 lm	18 W	80
	161-5978	LED-6/18W/4000K	1594.6 lm	18 W	80
	161-5977	LED-6/26W/3000K	1948.9 lm	26 W	80
	161-5979	LED-6/26W/4000K	2037.5 lm	26 W	80
 [R65] rectangular, side throw	161-5980	LED-6/18W/3000K	1457.1 lm	18 W	80
	161-5982	LED-6/18W/4000K	1524.9 lm	18 W	80
	161-5981	LED-6/26W/3000K	1863.7 lm	26 W	80
	161-5983	LED-6/26W/4000K	1948.5 lm	26 W	80
 [S70] asymmetric, side throw	161-5972	LED-6/18W/3000K	1597.1 lm	18 W	80
	161-5974	LED-6/18W/4000K	1671.3 lm	18 W	80
	161-5973	LED-6/26W/3000K	2042.8 lm	26 W	80
	161-5975	LED-6/26W/4000K	2135.6 lm	26 W	80