



**Description**

SPACE FRAME system allows for slidable placement, including terminal box, for mounting on  $\varnothing$  1.9-2.36" pipes or space frames.

IP66. Class I. IK08. Marine-grade, die-cast aluminum alloy. 5CE superior corrosion protection including PCS hardware. Silicone CCG® Controlled Compression Gasket. Safety glass lens, hinged. CAD-optimized optics for superior illumination and glare control. Integral driver. OLC® One LED Concept. Advanced thermal management protects LEDs while optimizing lumens output. 0-10V Dimming comes standard with luminaire. Luminaire is factory-sealed and does not need to be opened during installation.

Mount permits 355° rotation and 180° tilt.

Specify product with 7 Digit product code - Finish Color. Accessories, such as mounting, optical, and electrical, must be specified separately.

Example: XXX-XXXX-9004 (Black)  
+ XXX-XXXX (Accessory 1)

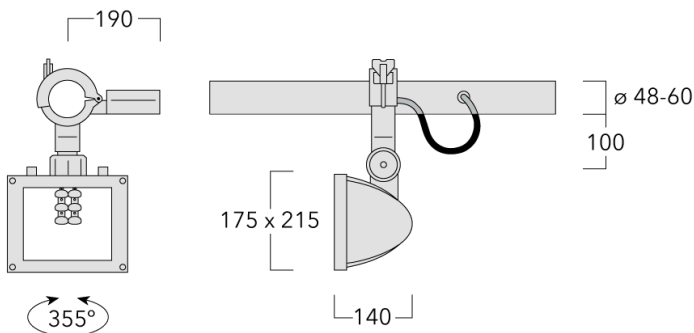

---

## Specifications

### Material description

Colors	<b>RAL9004</b> Signal black	<b>RAL9016</b> Traffic white	<b>RAL9007</b> Grey aluminium	<b>RAL8019</b> Grey brown
Ingress protection	IP66			
Impact resistance	IK08			

---





### Electrical description

Power supply	Integral [ECG] electronic driver 120V-277V. 0-10V dimmable, to be specified with order.			
--------------	---	--	--	--



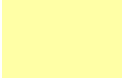

---

### Additional information

**Options**

Light distribution	Color temperature	Nominal Watt
 [P65] Type II Medium	 3000K	18 W 26 W
 [S70] Type II Short	 4000K	
 [A60] Type IV Very Short		
 [R65] Type IV Medium		

**Configurations**

Light distribution	Part ID	Light source	Delivered lumens	Rated input power	CRI
 <p>[A60] Type IV Very Short</p>	161-5984_us	LED-6/18W/3000K	1468.7 lm	18 W	80
	161-5986_us	LED-6/18W/4000K	1537 lm	18 W	80
	161-5985_us	LED-6/26W/3000K	1878.6 lm	26 W	80
	161-5987_us	LED-6/26W/4000K	1964 lm	26 W	80
 <p>[P65] Type II Medium</p>	161-5976_us	LED-6/18W/3000K	1523.7 lm	18 W	80
	161-5978_us	LED-6/18W/4000K	1594.6 lm	18 W	80
	161-5977_us	LED-6/26W/3000K	1948.9 lm	26 W	80
	161-5979_us	LED-6/26W/4000K	2037.5 lm	26 W	80
 <p>[R65] Type IV Medium</p>	161-5980_us	LED-6/18W/3000K	1457.1 lm	18 W	80
	161-5982_us	LED-6/18W/4000K	1524.9 lm	18 W	80
	161-5981_us	LED-6/26W/3000K	1863.7 lm	26 W	80
	161-5983_us	LED-6/26W/4000K	1948.5 lm	26 W	80
 <p>[S70] Type II Short</p>	161-5972_us	LED-6/18W/3000K	1597.1 lm	18 W	80
	161-5974_us	LED-6/18W/4000K	1671.3 lm	18 W	80
	161-5973_us	LED-6/26W/3000K	2042.8 lm	26 W	80
	161-5975_us	LED-6/26W/4000K	2135.6 lm	26 W	80