

**Description**

IP66, Class I. IK08. Marine-grade, die-cast aluminium alloy. 5CE superior corrosion protection including PCS hardware. Safety glass lens, hinged. Silicone CCG® Controlled Compression Gasket. Luminaire is factory-sealed and does not need to be opened during installation.

Integral EC electronic converter in thermally-separated compartment. Advanced thermal management protects LEDs while optimising lumens output. CAD-optimised optics for superior illumination and glare control. OLC® One LED Concept.

Including terminal box, for mounting on  $\varnothing$  48-60 mm pipes or space frames.

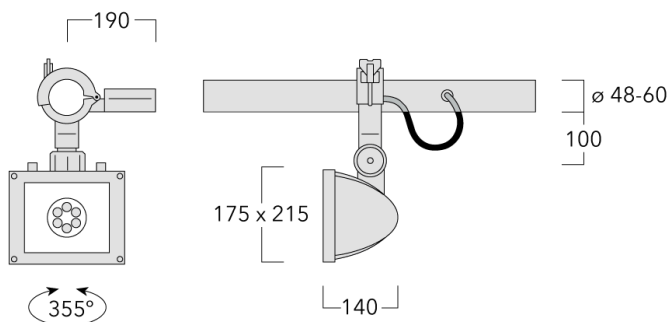

## Specifications

### Material description





Colours	<b>RAL9004</b> Signal black	<b>RAL9007</b> Grey aluminium	<b>RAL7016</b> Anthracite grey	<b>RAL9016</b> Traffic white
Ingress protection	IP66			
Impact resistance	IK08			

### Electrical description



Driver / Ballast	Integral EC electronic converter in thermally-separated compartment
------------------	---

### Additional information

**Options**

Light distribution	Colour temperature	Nominal Watt
 [B]	 3000K	18 W 26 W
 [M]	 4000K	
 [EE]		

## Configurations

Light distribution	Part ID	Light source	Rated lumens	Rated input power	CRI
 [B]	161-5960	LED-6/18W/3000K	2018.8 lm	18 W	80
	161-5962	LED-6/18W/4000K	2112.7 lm	18 W	80
	161-5961	LED-6/26W/3000K	2582.2 lm	26 W	80
	161-5963	LED-6/26W/4000K	2699.6 lm	26 W	80
 [EE]	161-5968	LED-6/18W/3000K	2165.6 lm	18 W	80
	161-5970	LED-6/18W/4000K	2266.4 lm	18 W	80
	161-5969	LED-6/26W/3000K	2770 lm	26 W	80
	161-5971	LED-6/26W/4000K	2895.9 lm	26 W	80
 [M]	161-5964	LED-6/18W/3000K	2167.2 lm	18 W	80
	161-5966	LED-6/18W/4000K	2268 lm	18 W	80
	161-5965	LED-6/26W/3000K	2772 lm	26 W	80
	161-5967	LED-6/26W/4000K	2898 lm	26 W	80