

Beschreibung

IP66, SKI. SKII auf Anfrage. IK07. Korrosionsbeständiger Aluminiumguss. PCS beschichtete Edelstahlschrauben. 5CE Korrosionsschutz. CCG® Controlled Compression Gasket Silikondichtung. Sicherheitsglas. Eingebaute elektronische Betriebsgeräte, thermisch getrennt. CAD-optimierte OLC® One LED Concept Technik zur Lichtlenkung und Entblendung. Eingebaute LED Platine.

Mit 0,4 m flexibler Anschlussleitung einschließlich Steckverbindung und Befestigungsklammer für RAIL66 Schienensystem.

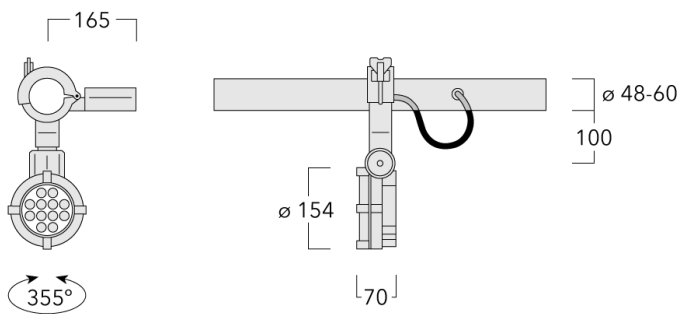

Spezifikationen

Materialbeschreibung

Gehäuse	Korrosionsbeständiger Aluminiumguss			
Abdeckung	Sicherheitsglasscheibe			
Farben	RAL9004 Signalschwarz	RAL9016 Verkehrsweiß	RAL7016 Anthrazitgrau	RAL9007 Graualuminium
Dichtung	Silikondichtung			
Schrauben	PCS beschichtete Edelstahlschrauben			
Schutzart	IP66			
Schlagfestigkeit	IK07			
Korrosionsbeständigkeit	5CE			







Elektrische Beschreibung

Netz	220-240V / 50-60 Hz
Netzgerät / Vorschaltgerät	Eingebaute elektronische Betriebsgeräte, thermisch getrennt
Überspannungsschutz	1/2 kV
Energieeffizienz	C-D (Lichtquelle)



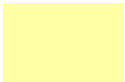

Weitere Informationen

Durchmesser (mm)	
Lebensdauer	Ta=25° L90B10 > 90000h

Auswahl

Lichtverteilung	Farbtemperaturen	Nominal Watt
 [M]	 3000K	24 W
 [EES]	 4000K	
 [B]	 2700K	
 [EE]		

Konfigurationen

Lichtverteilung	Artikelnummer	Lichtquelle	Bemessungslichtstrom	Bemessungsleistung	CRI
	146-0980	LED-12/24W/2700K	2522.3 lm	24 W	80
	146-0530	LED-12/24W/3000K	2709.2 lm	24 W	80
	146-0531	LED-12/24W/4000K	2896 lm	24 W	80
[B]					
	146-0982	LED-12/24W/2700K	2684.8 lm	24 W	80
	146-0982	LED-12/24W/2700K	2684.8 lm	24 W	80
	146-0533	LED-12/24W/3000K	2883.7 lm	24 W	80
	146-0533	LED-12/24W/3000K	2883.7 lm	24 W	80
	146-0534	LED-12/24W/4000K	3082.5 lm	24 W	80
[EE]					
	146-0983	LED-12/24W/2700K	2865.6 lm	24 W	80
	146-0983	LED-12/24W/2700K	2865.6 lm	24 W	80
	146-0414	LED-12/24W/3000K	3077.9 lm	24 W	80
	146-0414	LED-12/24W/3000K	3077.9 lm	24 W	80
	146-0415	LED-12/24W/4000K	3290.2 lm	24 W	80
	146-0415	LED-12/24W/4000K	3290.2 lm	24 W	80
[EES]					
	146-0981	LED-12/24W/2700K	2791.8 lm	24 W	80
	146-0981	LED-12/24W/2700K	2791.8 lm	24 W	80
	146-0411	LED-12/24W/3000K	2998.6 lm	24 W	80
	146-0411	LED-12/24W/3000K	2998.6 lm	24 W	80
	146-0412	LED-12/24W/4000K	3205.4 lm	24 W	80
	146-0412	LED-12/24W/4000K	3205.4 lm	24 W	80
[M]					