





**Description**

IP66, Class I. Class II on request. IK07. Marine-grade, die-cast aluminium alloy. 5CE superior corrosion protection including PCS hardware. Silicone CCG® Controlled Compression Gasket. Safety glass lens. Integral EC electronic converter in thermally separated compartment. CAD-optimised optics for superior illumination and glare control. OLC® One LED Concept. Factory installed LED circuit board.

Including 0,4 m of flexible cable enclosed in stainless conduit, in-line connector and mounting clamp for installation to RAIL66 mounting system.

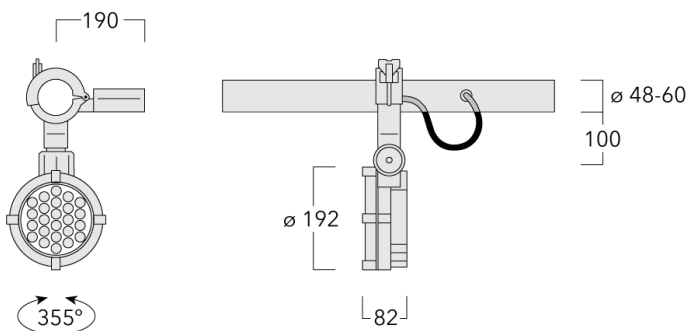

## Specifications

### Material description

Body	Marine-grade die-cast aluminium alloy			
Lens	Safety glass lens			
Colours	<b>RAL9004</b> Signal black	<b>RAL9006</b> White aluminium	<b>RAL9016</b> Traffic white	<b>RAL7016</b> Anthracite grey
	<b>RAL9007</b> Grey aluminium			
Gasket	Silicone rubber gasket			
Fasteners	PCS Polymer Coated Stainless Steel Hardware			
Ingress protection	IP66			
Impact resistance	IK07			
Corrosion resistance	5CE			

### Electrical description

Power supply	220-240V / 50-60 Hz
Driver / Ballast	Integral EC electronic converter in thermally-separated compartment
Surge protection	1/2 kV
Energy efficiency	C-D (Light source)

### Additional information





Lifetime	Ta=25° L90B10 > 90000h
----------	------------------------



**Options**

**Light distribution**

**Colour temperature**





**Nominal Watt**

- 
[M] symmetric, medium beam
- 
[EES] symmetric, very narrow beam, sharp cut-off
- 
[B] symmetric, wide beam
- 
[EE] symmetric, very narrow beam

- 
3000K
- 
4000K
- 
2700K

48 W

## Configurations

Light distribution	Part ID	Light source	Rated lumens	Rated input power	CRI
	146-0984	LED-24/48W/2700K	5016.9 lm	48 W	80
	146-7070	LED-24/48W/3000K	5388.5 lm	48 W	80
	146-7071	LED-24/48W/4000K	5760.1 lm	48 W	80
[B] symmetric, wide beam					
	146-0986	LED-24/48W/2700K	5573.3 lm	48 W	80
	146-7072	LED-24/48W/3000K	5986.1 lm	48 W	80
	146-7073	LED-24/48W/4000K	6398.9 lm	48 W	80
[EE] symmetric, very narrow beam					
	146-0987	LED-24/48W/2700K	5998.4 lm	48 W	80
	146-7060	LED-24/48W/3000K	6442.7 lm	48 W	80
	146-7061	LED-24/48W/4000K	6887 lm	48 W	80
[EES] symmetric, very narrow beam, sharp cut-off					
	146-0985	LED-24/48W/2700K	5630.1 lm	48 W	80
	146-7058	LED-24/48W/3000K	6047.2 lm	48 W	80
	146-7059	LED-24/48W/4000K	6464.2 lm	48 W	80
[M] symmetric, medium beam					