

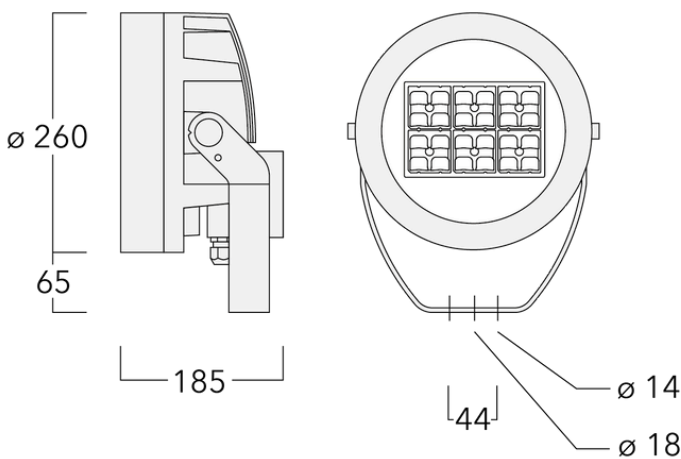



Description

Combining robust performance with the optical superiority of WE-EF street and area lighting lens', the FLC200 series of projectors is suited to landmark installations. Constructed from marine-grade, die-cast aluminium alloy, with an IP66 rating, 5CE superior corrosion protection including PCS hardware and CCG® Controlled Compression Gasket. Safety glass lens. One cable gland. Second gland for through wiring on request. Integral EC electronic converter, thermally separated. CAD-optimised optics for superior illumination and glare control. OLC® One LED Concept. Factory installed LED circuit board. 1-10V, DALI Interface or Eco Step Dim® on request. Maximum one internal optical accessory possible. Optional 2200 K version up to max. 1050mA available. To be specified at time of ordering.



Specifications

Material description

Body	Marine-grade, die-cast aluminium alloy			
Lens	Safety glass lens			
Colours	RAL9004	RAL9007	RAL7016	RAL9016
	Signal black	Grey aluminium	Anthracite grey	Traffic white
Gasket	Silicone CCG® Controlled Compression Gasket			
Fasteners	PCS Polymer Coated Stainless Steel Hardware			
Ingress protection	IP66			
Impact resistance	IK07			
Corrosion resistance	5CE			

Electrical description

Power supply	220-240V / 50-60 Hz
Driver / Ballast	Integral EC electronic convertor in thermally-separated compartment. DALI
Power factor	> 0.9
Surge protection	6/6 kV (optional SP10)
Energy efficiency	C-D (Light source)

Additional information

Lifetime	Ta=25° L90B10 > 90000h
----------	------------------------

Options

Light distribution

 [S65] asymmetric, side throw

 [S70] asymmetric, side throw

 [P65] pedestrian/bicycle lane

 [A60] asymmetric, forward throw

 [R60] rectangular, side throw

Colour temperature

 2200K

 2700K

 3000K

 4000K

Nominal Watt



24 W



36 W

48 W

72 W

Configurations

Light distribution	Part ID	Light source	Rated lumens	Rated input power	CRI
 <p>[A60] asymmetric, forward throw</p>	139-3362	LED-24/24W/2200K	2673.7 lm	24 W	70
	139-3363	LED-24/24W/2700K	2673.7 lm	24 W	80
	139-3364	LED-24/24W/3000K	2858.1 lm	24 W	80
	139-3365	LED-24/24W/4000K	3134.7 lm	24 W	80
	139-3386	LED-24/36W/2200K	3687.9 lm	36 W	70
	139-3387	LED-24/36W/2700K	3687.9 lm	36 W	80
	139-3388	LED-24/36W/3000K	3964.5 lm	36 W	80
	139-3389	LED-24/36W/4000K	4241.1 lm	36 W	80
	139-3410	LED-24/48W/2200K	4978.7 lm	48 W	70
	139-3411	LED-24/48W/2700K	4978.7 lm	48 W	80
	139-3412	LED-24/48W/3000K	5347.5 lm	48 W	80
	139-3413	LED-24/48W/4000K	5716.3 lm	48 W	80
	139-3434	LED-24/72W/2200K	7099.2 lm	72 W	70
	139-3435	LED-24/72W/2700K	6914.8 lm	72 W	80
	139-3436	LED-24/72W/3000K	7468 lm	72 W	80
	139-3437	LED-24/72W/4000K	7929 lm	72 W	80
	 <p>[P65] pedestrian/bicycle lane</p>	139-3358	LED-24/24W/2200K	2762.1 lm	24 W
139-3359		LED-24/24W/2700K	2762.1 lm	24 W	80
139-3360		LED-24/24W/3000K	2952.6 lm	24 W	80
139-3361		LED-24/24W/4000K	3238.3 lm	24 W	80
139-3382		LED-24/36W/2200K	3809.8 lm	36 W	70
139-3383		LED-24/36W/2700K	3809.8 lm	36 W	80
139-3384		LED-24/36W/3000K	4095.5 lm	36 W	80
139-3385		LED-24/36W/4000K	4381.2 lm	36 W	80
139-3406		LED-24/48W/2200K	5143.2 lm	48 W	70
139-3407		LED-24/48W/2700K	5143.2 lm	48 W	80
139-3408		LED-24/48W/3000K	5524.2 lm	48 W	80
139-3409		LED-24/48W/4000K	5905.1 lm	48 W	80
139-3430		LED-24/72W/2200K	7333.8 lm	72 W	70
139-3431		LED-24/72W/2700K	7143.3 lm	72 W	80
139-3432		LED-24/72W/3000K	7714.8 lm	72 W	80
139-3433		LED-24/72W/4000K	8191 lm	72 W	80
139-3366		LED-24/24W/2200K	2588.1 lm	24 W	70
139-3367	LED-24/24W/2700K	2588.1 lm	24 W	80	

Light distribution	Part ID	Light source	Rated lumens	Rated input power	CRI	
 <p>[R60] rectangular, side throw</p>	139-3368	LED-24/24W/3000K	2766.6 lm	24 W	80	
	139-3369	LED-24/24W/4000K	3034.4 lm	24 W	80	
	139-3390	LED-24/36W/2200K	3569.9 lm	36 W	70	
	139-3391	LED-24/36W/2700K	3569.9 lm	36 W	80	
	139-3392	LED-24/36W/3000K	3837.6 lm	36 W	80	
	139-3393	LED-24/36W/4000K	4105.3 lm	36 W	80	
	139-3414	LED-24/48W/2200K	4819.3 lm	48 W	70	
	139-3415	LED-24/48W/2700K	4819.3 lm	48 W	80	
	139-3416	LED-24/48W/3000K	5176.3 lm	48 W	80	
	139-3417	LED-24/48W/4000K	5533.3 lm	48 W	80	
	139-3438	LED-24/72W/2200K	6872 lm	72 W	70	
	139-3439	LED-24/72W/2700K	6693.5 lm	72 W	80	
	139-3440	LED-24/72W/3000K	7229 lm	72 W	80	
	139-3641	LED-24/72W/4000K	7675.2 lm	72 W	80	
 <p>[S65] asymmetric, side throw</p>	139-3350	LED-24/24W/2200K	2816.5 lm	24 W	70	
	139-3351	LED-24/24W/2700K	2816.5 lm	24 W	80	
	139-3352	LED-24/24W/3000K	3010.8 lm	24 W	80	
	139-3353	LED-24/24W/4000K	3302.2 lm	24 W	80	
	139-3374	LED-24/36W/2200K	3884.9 lm	36 W	70	
	139-3375	LED-24/36W/2700K	3884.9 lm	36 W	80	
	139-3376	LED-24/36W/3000K	4176.3 lm	36 W	80	
	139-3377	LED-24/36W/4000K	4467.6 lm	36 W	80	
	139-3398	LED-24/48W/2200K	5244.6 lm	48 W	70	
	139-3399	LED-24/48W/2700K	5244.6 lm	48 W	80	
	139-3400	LED-24/48W/3000K	5633.1 lm	48 W	80	
	139-3401	LED-24/48W/4000K	6021.6 lm	48 W	80	
	139-3422	LED-24/72W/2200K	7478.4 lm	72 W	70	
	139-3423	LED-24/72W/2700K	7284.2 lm	72 W	80	
	139-3424	LED-24/72W/3000K	7866.9 lm	72 W	80	
	139-3425	LED-24/72W/4000K	8352.5 lm	72 W	80	
	 <p>[S70] asymmetric, side throw</p>	139-3354	LED-24/24W/2200K	2706.8 lm	24 W	70
		139-3355	LED-24/24W/2700K	2706.8 lm	24 W	80
139-3356		LED-24/24W/3000K	2893.4 lm	24 W	80	
139-3357		LED-24/24W/4000K	3173.4 lm	24 W	80	
139-3378		LED-24/36W/2200K	3733.4 lm	36 W	70	
139-3379		LED-24/36W/2700K	3733.4 lm	36 W	80	

Light distribution	Part ID	Light source	Rated lumens	Rated input power	CRI
	139-3380	LED-24/36W/3000K	4013.5 lm	36 W	80
	139-3381	LED-24/36W/4000K	4293.5 lm	36 W	80
	139-3402	LED-24/48W/2200K	5040.2 lm	48 W	70
	139-3403	LED-24/48W/2700K	5040.2 lm	48 W	80
	139-3404	LED-24/48W/3000K	5413.5 lm	48 W	80
	139-3405	LED-24/48W/4000K	5786.8 lm	48 W	80
	139-3426	LED-24/72W/2200K	7186.9 lm	72 W	70
	139-3427	LED-24/72W/2700K	7000.2 lm	72 W	80
	139-3428	LED-24/72W/3000K	7560.2 lm	72 W	80
	139-3429	LED-24/72W/4000K	8026.9 lm	72 W	80