





Description

Changement de couleurs RGBW. IP66. Classe I. IK07.
Corps en fonte d'aluminium. Visserie inox avec traitement
PCS. Protection contre la corrosion 5CE. Joint silicone
CCG®. Verre de sécurité. LED contrôlables par système
DMX.

Technologie sans fil DMX Wireless disponible.

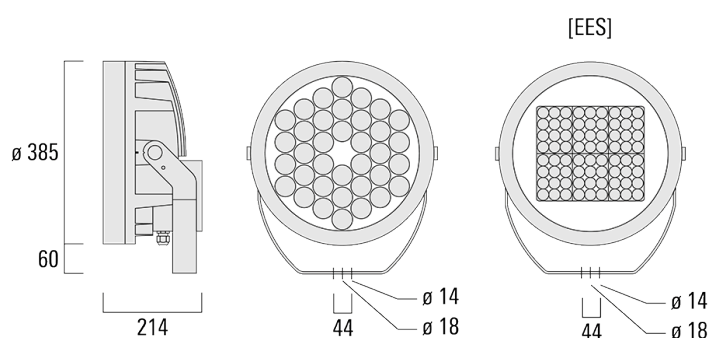

Spécifications

Description du matériel

Corps	Corps en fonte d'aluminium
Lentille	Verre de sécurité
Couleurs	Peinture poudre disponible avec 35 couleurs différents
Joint	Joint silicone CCG®
Visserie	PCS Polymer Coated Stainless Steel Hardware
IP	IP66
IK	IK07
Protection contre la corrosion	5CE

Description électrique





Alimentation électrique	220-240V / 50-60 Hz
Driver	DMX
Protection contre les surtensions	1/2 kV (optional SP10)
Efficacité énergétique	G

Informations complémentaires





Diamètre (mm)	
Surface exposée au vent	0.116 m ²
Durée de vie	Ta=25° L90B10 > 90000h

Options

Types photométries Température de couleur Données en sortie de luminaire

 [M]	4000K+RGBW	144 W 126 W
 [E]	RGBA	
 [B]		
 [EES]		

Configurations

Types photométries	Code produit	Type de Lampes	Rated lumens	Rated input power	IRC
	139-1965	LED-36/144W/4000K+RGBW	10133.6 lm	144 W	80
	139-2143	LED-36/144W/RGBA	9080.7 lm	144 W	80
[B]					
	139-1891	LED-36/144W/4000K+RGBW	10679.4 lm	144 W	80
	139-1891	LED-36/144W/4000K+RGBW	10679.4 lm	144 W	80
	139-2144	LED-36/144W/RGBA	9569.8 lm	144 W	80
	139-2144	LED-36/144W/RGBA	9569.8 lm	144 W	80
[E]					
	139-2428	LED-4x18/126W/4000K+RGBW	7719.9 lm	126 W	80
	139-2430	LED-4x18/126W/RGBA	7641.9 lm	126 W	80
[EES]					
	139-1889	LED-36/144W/4000K+RGBW	10887.4 lm	144 W	80
	139-1889	LED-36/144W/4000K+RGBW	10887.4 lm	144 W	80
	139-2145	LED-36/144W/RGBA	9756.2 lm	144 W	80
	139-2145	LED-36/144W/RGBA	9756.2 lm	144 W	80
[M]					