





Description

Tunable White.

IP66. Class I. IK07. Marine-grade, die-cast aluminum alloy. 5CE superior corrosion protection including PCS hardware. Silicone CCG® Controlled Compression Gasket. Safety glass lens. One cable gland, second gland for through wiring on request. CAD-optimized optics for superior illumination and glare control. Integral driver, thermally separated. OLC® One LED Concept. Factory-installed LED circuit board. Tunable White technology. DMX interface.

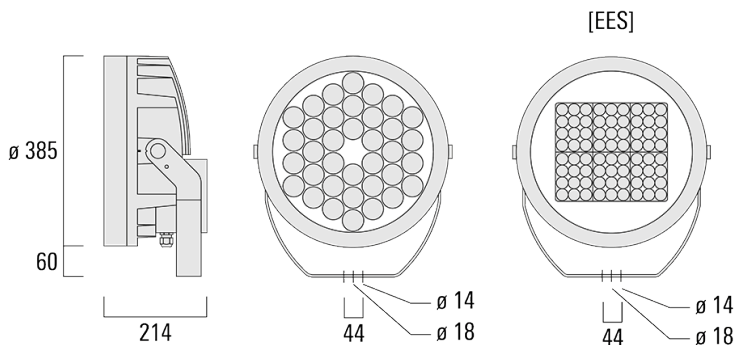

Specify product with 7 Digit product code - Finish Color. Accessories, such as mounting, optical, and electrical, must be specified separately.

Example: XXX-XXXX-9004 (Black)
+ XXX-XXXX (Accessory 1)

Specifications

Material description

Colors	RAL9004 Signal black	RAL9007 Grey aluminium	RAL9016 Traffic white	RAL8019 Grey brown
Ingress protection	IP66			
Impact resistance	IK07			





Electrical description

Power supply	Integral [ECG] electronic driver 120V-277V. DMX enabled driver.
Driver / Ballast	120-277V DMX
Surge protection	Integral 10kV Surge Protector
Energy efficiency	E (Light source)



Additional information

Listings	ETL, UL-1598, CSA-C22.2#250.0. Suitable for Wet Locations.
Windage	1.5
Lifetime	Ta=25°/40° L90B10 > 90000h

Options

Light distribution	Color temperature	Nominal Watt
 [W] bi-symmetric, wide beam	2200-6000K	132 W 72 W
 [M] symmetric, medium beam	2700-6000K	
 [N] bi-symmetric, narrow beam		
 [EES] symmetric, very narrow beam, sharp cut-off		

Configurations

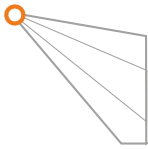
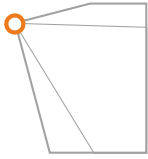
Light distribution	Part ID	Light source	Delivered lumens	Rated input power	CRI
 <p>[EES] symmetric, very narrow beam, sharp cut-off</p>	139-2431	LED-72/72W/2700-6000K	6386.9 lm	72 W	80
 <p>[M] symmetric, medium beam</p>	139-2051_us	LED-36/132W/2200-6000K	12174 lm	132 W	80
 <p>[N] bi-symmetric, narrow beam</p>	139-2052_us	LED-36/132W/2200-6000K	12386.8 lm	132 W	80
 <p>[W] bi-symmetric, wide beam</p>	139-2050_us	LED-36/132W/2200-6000K	11447.3 lm	132 W	80