

Description

IP66, Class I. IK07. Marine-grade, die-cast aluminium alloy. 5CE superior corrosion protection + primer including PCS hardware. Safety glass lens. Silicone CCG® Controlled Compression Gasket.

Integral EC electronic converter in thermally-separated compartment. Advanced thermal management protects LEDs while optimising lumens output. CAD-optimised optics for superior illumination and glare control. OLC_R_ One LED Concept.

Including terminal box, for mounting on ø 48-60 mm pipes or space frames.

2700 K option available on request.

If ordering a fitting to be installed on an existing rail, please confirm the rail version with your local distributor or our customer excellence team as connectors vary.

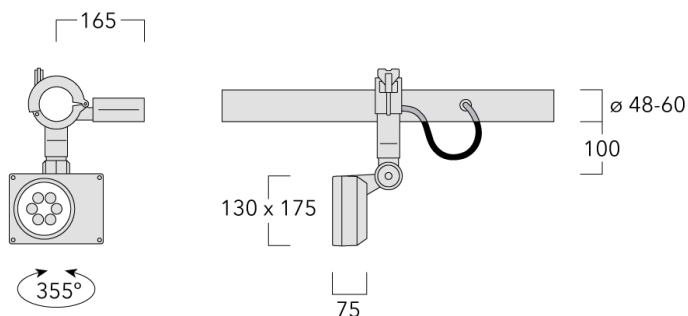

Specifications

Material description

Body	Marine-grade die-cast aluminium alloy						
Lens	Safety glass lens						
Colours	<table><tr><td>RAL9004</td><td>RAL9006</td><td>RAL9007</td></tr><tr><td>Signal black</td><td>White aluminium</td><td>Grey aluminium</td></tr></table>	RAL9004	RAL9006	RAL9007	Signal black	White aluminium	Grey aluminium
RAL9004	RAL9006	RAL9007					
Signal black	White aluminium	Grey aluminium					
Gasket	Silicone CCG® Controlled Compression Gasket						
Fasteners	PCS Polymer Coated Stainless Steel Hardware (unpainted)						
Impact resistance	IK07						
Corrosion resistance	5CE+Primer						





Electrical description

Driver / Ballast	Integral EC electronic converter in thermally-separated compartment
Energy efficiency	The product is supplied with 10-year warranty. Please refer to the LED Warranty Statement located on www.we-ef.com for further details.



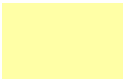

Additional information

Options

Light distribution Colour temperature Nominal Watt

	[M]		3000K	12 W
	[B]		4000K	
	[EE]			
	[EES]			

Configurations

Light distribution	Part ID	Light source	Rated lumens	Rated input power	CRI
	145-9520	LED-6/12W/3000K	1148.3 lm	12 W	80
	145-9521	LED-6/12W/4000K	1227.5 lm	12 W	80
[B]					
	145-9522	LED-6/12W/3000K	1393.4 lm	12 W	80
	145-9523	LED-6/12W/4000K	1489.5 lm	12 W	80
[EE]					
	145-9524	LED-6/12W/3000K	1492.9 lm	12 W	80
	145-9525	LED-6/12W/4000K	1595.9 lm	12 W	80
[EES]					
	145-9518	LED-6/12W/3000K	1454.1 lm	12 W	80
	145-9518	LED-6/12W/3000K	1454.1 lm	12 W	80
	145-9519	LED-6/12W/4000K	1554.3 lm	12 W	80
	145-9519	LED-6/12W/4000K	1554.3 lm	12 W	80
[M]					