



Description

IP66, Class I. IK07. Marine-grade, die-cast aluminium alloy. 5CE superior corrosion protection + primer including PCS hardware. Safety glass lens. Silicone CCG® Controlled Compression Gasket.

Integral EC electronic converter in thermally-separated compartment. Advanced thermal management protects LEDs while optimising lumens output. CAD-optimised optics for superior illumination and glare control. OLC® One LED Concept.

Including terminal box, for mounting on ø 48-60 mm pipes or space frames.

2700 K option available on request.

If ordering a fitting to be installed on an existing rail, please confirm the rail version with your local distributor or our customer excellence team as connectors vary.

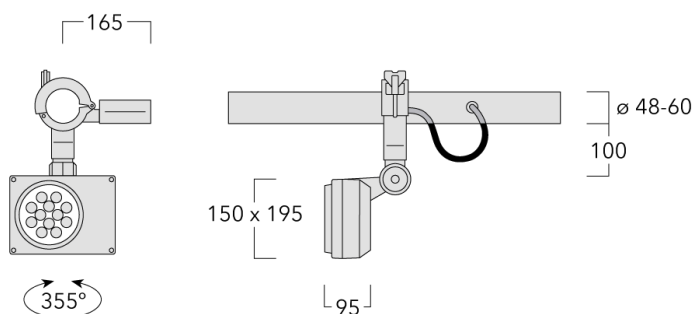

Specifications

Material description







Body	Marine-grade, die-cast aluminium alloy						
Lens	Safety glass lens						
Colours	<table><tr><td>RAL9004</td><td>RAL9006</td><td>RAL9007</td></tr><tr><td>Signal black</td><td>White aluminium</td><td>Grey aluminium</td></tr></table>	RAL9004	RAL9006	RAL9007	Signal black	White aluminium	Grey aluminium
RAL9004	RAL9006	RAL9007					
Signal black	White aluminium	Grey aluminium					
Gasket	Silicone CCG® Controlled Compression Gasket						
Fasteners	PCS Polymer Coated Stainless Steel Hardware (unpainted)						
Impact resistance	IK07						
Corrosion resistance	5CE+Primer						

Electrical description





Driver / Ballast	EC electronic converter in thermally-separated compartment
Energy efficiency	The product is supplied with 10-year warranty. Please refer to the LED Warranty Statement located on www.we-ef.com for further details.

Additional information

Options

Light distribution	Colour temperature	Nominal Watt
 [EES]	 4000K	24 W
 [M]	 3000K	
 [EE]		
 [B]		

Configurations

Light distribution	Part ID	Light source	Rated lumens	Rated input power	CRI
	145-9612	LED-12/24W/3000K	2296.7 lm	24 W	80
	145-9614	LED-12/24W/4000K	2455 lm	24 W	80
[B]					
	145-9564	LED-12/24W/3000K	2786.9 lm	24 W	80
	145-9567	LED-12/24W/4000K	2979.1 lm	24 W	80
[EE]					
	145-9613	LED-12/24W/3000K	2985.8 lm	24 W	80
	145-9615	LED-12/24W/4000K	3191.8 lm	24 W	80
[EES]					
	145-9563	LED-12/24W/3000K	2908.1 lm	24 W	80
	145-9563	LED-12/24W/3000K	2908.1 lm	24 W	80
	145-9566	LED-12/24W/4000K	3108.7 lm	24 W	80
	145-9566	LED-12/24W/4000K	3108.7 lm	24 W	80
[M]					